

Attachment B
Transportation Analysis Report



State Route 65
Capacity and Operational Improvements
Transportation Analysis Report

Placer County, CA
03-PLA-65-PM R6.5 to R12.9

EA 03-1F1700
Project ID 0300001103

September 2015



PLACER COUNTY
TRANSPORTATION
PLANNING AGENCY



Transportation Analysis Report

State Route 65
Capacity and Operational Improvements

03-PLA-65-PM R6.5 to R12.9

EA 03-1F1700
Project ID 0300001103

September 2015

Prepared By: David Stanek, PE Date: _____
Ronald T. Milam, AICP, PTP

Phone Number 916-773-1900
Firm Name Fehr & Peers
Location Roseville, CA

Planning
Approved By:  Date: 10/15/15

Name NICHOLAS DEAL
Title SR. TRANSPORTATION PLANNER
Phone Number (530) 741-5151
Office Name OTFM
District/Region 03/NR

Traffic Operations
Approved By:  Date: October 15, 2015

Name Christine M. Zdunkiewicz
Title Transportation Engineer
Phone Number (916) 859 - 7949
Office Name Caltrans District 3 Freeway Operations
District/Region District 3/North Region

Transportation Analysis Report

State Route 65
Capacity and Operational Improvements

03-PLA-65-PM R6.5 to R12.9

EA 03-1F1700
Project ID 0300001103

September 2015

This report was prepared under my direction and responsible charge. I attest to the technical information contained herein and have judged the qualification of any technical specialists providing engineering data upon which recommendations, conclusions, and decisions are based.





David Stanek, P.E.
Registered Professional Civil Engineer
Fehr & Peers

9/10/15
Date

RS14-3201

Table of Contents

Chapter 1. Introduction 1

 1.1. Purpose of the Transportation Analysis Report 1

 1.2. Project Description 1

 1.3. Project Purpose and Need..... 3

 1.3.1. Logical Termini and Independent Utility 3

 1.4. Project Alternatives 3

 1.5. Design Options 5

Chapter 2. Analysis Methodology..... 9

 2.1. Study Area 9

 2.2. Data Collection Methods 9

 2.2.1. Geometric Data 9

 2.2.2. Traffic Control Data..... 11

 2.2.3. Traffic Flow Data 11

 2.2.4. Travel Time Data 12

 2.3. Travel Forecasting Methodology 12

 2.3.1. Socioeconomic Forecasts 13

 2.3.2. Planned Transportation Network 13

 2.4. Traffic Operations Analysis Methodology 14

 2.5. Evaluation Criteria..... 21

Chapter 3. Existing (2012) Conditions 24

 3.1. Meso-Scale Network Performance..... 24

 3.2. Traffic Operations 24

 3.2.1. Freeway Operations..... 25

 3.2.2. Arterial Intersection Operations..... 33

 3.3. Traffic Safety 35

Chapter 4. Travel Demand Forecasts..... 36

 4.1. Sub-Area Model Development and Model Validation 36

 4.2. Future Year Forecasts 36

 4.2.1. Design Year Forecasts..... 36

 4.2.2. HOV Volume Forecasts..... 44

 4.2.3. Meso-Scale Network Performance for Design Year 45

 4.2.4. Construction Year Forecasts 51

 4.2.5. Meso-Scale Network Performance for Construction Year 51

 4.2.6. Induced Travel 60

 4.2.7. Daily Forecasts 60

Chapter 5. Traffic Operations Analysis..... 62

 5.1. Design Year Conditions 62

 5.1.1. Freeway Operations..... 64

 5.1.2. Arterial Intersection Operations..... 77

 5.1.3. Ramp Meter Operations 81

 5.2. Construction Year Conditions 83

5.2.1.	Freeway Operations	85
5.2.2.	Arterial Intersection Operations.....	98
Chapter 6.	Summary and Conclusions	103
6.1.	Deficiencies	103
6.2.	Project Impacts	106
6.3.	Potential Mitigation Measures.....	107
6.4.	Safety Assessment	109
6.5.	Comparison of Project Alternatives	109
Chapter 7.	References	111

List of Figures

Figure 1 – Project Vicinity 2

Figure 2 – Roadway Improvements Assumed to be Constructed by 2020 6

Figure 3 – Roadway Improvements Assumed to be Constructed by 2040 7

Figure 4 – Study Area 10

Figure 5 – Modified SACMET Land Use Summary by Analysis District 15

Figure 6 – AM and PM Peak Hour Traffic Volumes and Lane Configurations – Existing Conditions
..... 26

Figure 7 – Eastbound I-80 from Taylor Road Overcrossing (PM Peak Hour) 27

Figure 8 – Eastbound I-80 from Roseville Pkwy Overcrossing (PM Peak Hour) 27

Figure 9 – Northbound SR 65 Existing Conditions Speed Contour Maps 29

Figure 10 – Southbound SR 65 Existing Conditions Speed Contour Maps 30

Figure 11 – Eastbound I-80 Existing Conditions Speed Contour Maps 31

Figure 12 – Westbound I-80 Existing Conditions Speed Contour Maps 32

Figure 13 – Design Year Peak Hour Traffic Volumes and Lane Configurations – Carpool Lane
(Alternative 1) 40

Figure 14 – Design Year Peak Hour Traffic Volumes and Lane Configurations – General Purpose
Lane (Alternative 2) 41

Figure 15 – Design Year Peak Hour Traffic Volumes and Lane Configurations – No Build
(Alternative 3) 42

Figure 16 – Volume Comparison of Alternatives 2 and 3 43

Figure 17 – Volume Comparison of Alternatives 1 and 2 44

Figure 18 – Design Year Meso-Scale VMT Comparison 46

Figure 19 – Design Year Meso-Scale VHT Comparison 47

Figure 20 – Design Year Meso-Scale VHD Comparison 48

Figure 21 – Design Year Meso-Scale Freeway VHD Comparison 49

Figure 22 – Design Year Meso-Scale Project-Area Freeway VHD Comparison 50

Figure 23 – Construction Year Peak Hour Traffic Volumes and Lane Configurations – Carpool
Lane (Alternative 1) 52

Figure 24 – Construction Year Peak Hour Traffic Volumes and Lane Configurations – General
Purpose Lane (Alternative 2) 53

Figure 25 – Construction Year Peak Hour Traffic Volumes and Lane Configurations – No Build
(Alternative 3) 54

Figure 26 – Construction Year Meso-Scale VMT Comparison 55

Figure 27 – Construction Year Meso-Scale VHT Comparison 56

Figure 28 – Construction Year Meso-Scale VHD Comparison 57

Figure 29 – Construction Year Meso-Scale Freeway VHD Comparison 58

Figure 30 – Construction Year Meso-Scale Project-Area Freeway VHD Comparison 59

Figure 31 – Freeway Served Volume for Design Year Conditions 65

Figure 32 – Northbound SR 65 Design Year AM Peak Period Speed Contour Map 68

Figure 33 – Northbound SR 65 Design Year PM Peak Period Speed Contour Map 69

Figure 34 – Southbound SR 65 Design Year AM Peak Period Speed Contour Map 70

Figure 35 – Southbound SR 65 Design Year PM Peak Period Speed Contour Map.....	71
Figure 36 – Eastbound I-80 Design Year AM Peak Period Speed Contour Map	72
Figure 37 – Eastbound I-80 Design Year PM Peak Period Speed Contour Map.....	73
Figure 38 – Westbound I-80 Design Year AM Peak Period Speed Contour Map	74
Figure 39 – Westbound I-80 Design Year PM Peak Period Speed Contour Map.....	75
Figure 40 – Freeway Served Volume for Construction Year Conditions	86
Figure 41 – Northbound SR 65 Construction Year AM Peak Period Speed Contour Map	89
Figure 42 – Northbound SR 65 Construction Year PM Peak Period Speed Contour Map.....	90
Figure 43 – Southbound SR 65 Construction Year AM Peak Period Speed Contour Map	91
Figure 44 – Southbound SR 65 Construction Year PM Peak Period Speed Contour Map.....	92
Figure 45 – Eastbound I-80 Construction Year AM Peak Period Speed Contour Map	93
Figure 46 – Eastbound I-80 Construction Year PM Peak Period Speed Contour Map.....	94
Figure 47 – Westbound I-80 Construction Year AM Peak Period Speed Contour Map	95
Figure 48 – Westbound I-80 Construction Year PM Peak Period Speed Contour Map.....	96

List of Tables

Table 1: Hourly HOV and Truck Percentage	11
Table 2: Planned Separate Projects	16
Table 3: Freeway LOS Thresholds.....	19
Table 4: Signalized Intersection LOS Thresholds.....	19
Table 5: Peak Period Meso-Scale Network Performance Summary – Existing (2012) Conditions	24
Table 6: Peak Period Micro-Scale Network Performance Summary – Existing (2012) Conditions	25
Table 7: Selected Freeway Operations Results – Existing (2012) Conditions	28
Table 8: Selected Intersection Operations Results – Existing (2012) Conditions	34
Table 9: Accident History	35
Table 10: Mainline Collisions By Type	35
Table 11: Peak Period HOV Percentage for I-80 Western Gateway.....	37
Table 12: Carpool Lane Peak Hour Volume for Design Year Conditions	45
Table 13: Average Annual Daily Traffic Volume	61
Table 14: Comparison of Overall Network Performance – Design Year AM Peak Period	62
Table 15: Comparison of Overall Network Performance – Design Year PM Peak Period.....	63
Table 16: Selected Freeway Operations Results – Design Year AM Peak Hour Conditions.....	66
Table 17: Selected Freeway Operations Results – Design Year PM Peak Hour Conditions	67
Table 18: Intersection Operations Results – Design Year AM Peak Hour Conditions	78
Table 19: Intersection Operations Results – Design Year PM Peak Hour Conditions.....	79
Table 20: Selected Maximum Queue Length Results – Design Year AM Peak Hour Conditions...	80
Table 21: Selected Maximum Queue Length Results – Design Year PM Peak Hour Conditions ...	80
Table 22: SR 65 Ramp Configuration.....	82
Table 23: Comparison of Overall Network Performance – Construction Year AM Peak Period	83
Table 24: Comparison of Overall Network Performance – Construction Year PM Peak Period.....	84
Table 25: Selected Freeway Operations Results – Construction Year AM Peak Hour Conditions.	87
Table 26: Selected Freeway Operations Results – Construction Year PM Peak Hour Conditions.	88
Table 27: Intersection Operations Results – Construction Year AM Peak Hour Conditions.....	98
Table 28: Intersection Operations Results – Construction Year PM Peak Hour Conditions	99
Table 29: Selected Maximum Queue Length Results – Construction Year AM Peak Hour Conditions.....	100
Table 30: Selected Maximum Queue Length Results – Construction Year PM Peak Hour Conditions.....	100
Table 31: Alternative Comparison Summary – Design Year Peak Period Conditions	110

Chapter 1. Introduction

This transportation analysis report was prepared for the State Route 65 (SR 65) Capacity and Operational Improvements project. The report contains the results and findings of the traffic forecasts and traffic operation analysis, while the detailed analysis calculations are compiled in the separately bound Technical Appendix.

1.1. Purpose of the Transportation Analysis Report

The purpose of this report is to analyze project design alternatives and their effects on the highway and arterial transportation network. The report focuses on a comparison of alternatives that are each designed to improve future traffic operations and safety for the SR 65 corridor consistent with the purpose and need statement. Portions of the analysis results will also be used to comply with environmental impact analysis requirements for the California Environmental Quality Act (CEQA) and National Environmental Policy Act (NEPA).



1.2. Project Description

The proposed project is located on SR 65 in Placer County from the Galleria Boulevard/Stanford Ranch Road Interchange in Roseville to the Ferrari Ranch Road Interchange in Lincoln. Figure 1 shows the project vicinity and location map. The project would increase capacity for the SR 65 corridor with the following improvements.

- Widen southbound SR 65 from Blue Oaks Boulevard to Pleasant Grove Boulevard by one lane in the median
- Widen northbound and southbound SR 65 to add a lane to the outside at Pleasant Grove Boulevard
- Construct an auxiliary lane in each direction between Galleria Boulevard/Stanford Ranch Road and Pleasant Grove Boulevard, Blue Oaks Boulevard and Sunset Boulevard, and Placer Parkway/Whitney Ranch Parkway (a future interchange) and Twelve Bridges Drive
- Install ramp meters and widen ramps as needed to provide storage from Pleasant Grove Boulevard to Lincoln Boulevard

Along with the separate projects for the I-80/SR 65 interchange and the SR 65/Placer Parkway/Whitney Ranch Parkway interchange, auxiliary lanes ultimately would be provided between all interchanges on SR 65 between I-80 in Roseville and Lincoln Boulevard in Lincoln.

LEGEND

-  County Boundary
-  Project Location

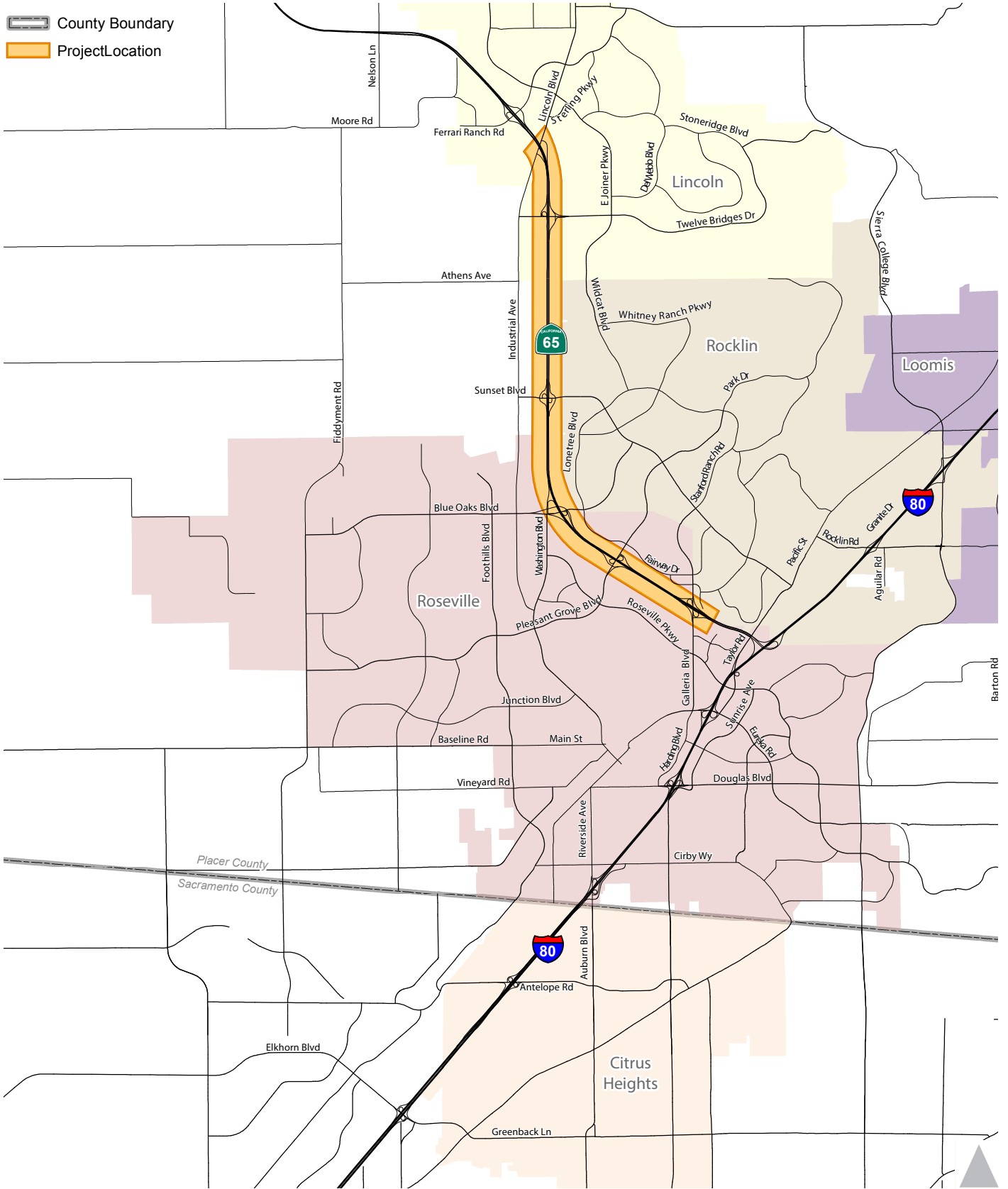

Figure 1

Project Vicinity



1.3. Project Purpose and Need

The current purpose and need statement for the SR 65 Capacity and Operational Improvements project is provided below.

The primary purpose of this project is to relieve existing mainline congestion by adding additional mainline capacity. Adding additional capacity would help planned and anticipated growth along the corridor and would help achieve the mobility and economic development goals of the PCTPA. The project will improve traffic operations and safety in this segment of the highway.

The project is needed for the following reasons.

- Recurring morning and evening peak-period demand exceeds the current design capacity along SR 65, creating traffic operations and safety issues. These issues result in high delays and wasted fuel, all of which will be exacerbated by traffic from future population and employment growth.
- Projected growth along the SR 65 corridor in Roseville, Lincoln, Rocklin, and South Placer County will result in additional mainline congestion. This state route connects major regional routes and must operate efficiently in order to serve commuter traffic, goods movement, and regional traffic in South Placer County.

1.3.1. Logical Termini and Independent Utility

Project limits for proposed improvements were developed through an iterative process involving engineering design and traffic operations analysis. Preliminary design concepts were tested with the traffic operations analysis model to evaluate how lane transitions and weaving influenced peak hour conditions. Refinements were made to ensure that mainline lane balance was logical and that transitions did not cause unacceptable traffic operations such as extensive queuing or reduced speeds.

1.4. Project Alternatives

The project study report (PSR) evaluated two main build alternatives: widen to provide carpool or general purpose lanes between Roseville and Lincoln. Through an alternative assessment and screening process, the project development team (PDT) refined the alternatives and deferred the mainline widening north of Blue Oaks Boulevard to a separate future project. The final set of alternatives is listed below.

1. Carpool Lane
2. General Purpose Lane
3. No Build

Each of the alternatives is described below. See Figures 13, 14, and 15 for lane configuration details.

Both build alternatives would have the following three elements.

- An additional general purpose lane would be constructed to the outside in both directions at the Pleasant Grove Boulevard overcrossing to connect the existing auxiliary lanes between Pleasant Grove Boulevard and Blue Oaks Boulevard with future lanes to be built south of Pleasant Grove Boulevard under the separate I-80/SR 65 Interchange Improvements Phase 1 project.
- Auxiliary lanes would be constructed in both directions between Galleria Boulevard/Stanford Ranch Road and Pleasant Grove Boulevard, Blue Oaks Boulevard and Sunset Boulevard, and Placer Parkway/Whitney Ranch Parkway (a future interchange) and Twelve Bridges Drive.
- Ramp meters would be installed at all ramps in both directions from Pleasant Grove Boulevard to Lincoln Boulevard with some ramps widened to provide an HOV preferential lane or a second storage lane. See Section 5.1.3 for the recommended ramp meter configurations.

The Carpool Lane Alternative would widen southbound SR 65 in the median to provide a lane restricted to HOVs – carpools, vanpools, buses, motorcycles, or any non-truck vehicle with two or more occupants – during the AM and PM peak periods from just north of the Blue Oaks Boulevard westbound on-ramp to the Galleria Boulevard overcrossing. The lane is designed to fit with the ultimate configuration of the I-80/SR 65 Interchange, which has a median direct connector ramp from southbound SR 65 to westbound I-80. Under construction year conditions, the HOV restriction would end midway between Pleasant Grove Boulevard and Galleria Boulevard. A lane drop would be needed south of the Galleria Boulevard off-ramp to conform to the Phase 1 of the I-80/SR 65 Interchange Improvements project that is anticipated to be built by construction year conditions¹. In the General Purpose Lane Alternative, the added southbound median lane would be open to all traffic. The median widening would end just after the Pleasant Grove Boulevard interchange under this alternative because no lane drop would be needed to conform to the I-80/SR 65 Interchange Phase 1 project improvements.

Under the No Build (or No Project) Alternative, no widening of the SR 65 mainline would be made at Pleasant Grove Boulevard or in the southbound direction between Blue Oaks Boulevard and Galleria Boulevard. Additionally, the auxiliary lanes at the three locations noted above would not be constructed. However, numerous transportation capacity expansion projects are planned to be constructed within the study area under construction year (2020) and design year (2040) conditions as displayed in Figures 2 and 3, respectively. In addition, the ramp meter installations are assumed to be provided under a separate project if one of the build alternatives is not built. All of these projects are assumed to be in place under

¹ Subsequent to the traffic analysis, the PDT determined that the initial phase of the Carpool Lane Alternative would not construct the southbound HOV lane to traffic until the I-80/SR 65 Interchange's ultimate phase was completed. Given the low HOV lane demand under construction year conditions, the analysis results without the HOV lane would be similar to the results presented in this report.

all alternatives. The Lincoln Bypass and the Eureka Road widening at Taylor Road are shown as future projects because the traffic data for existing conditions was collected before these project were completed. Please see Chapter 2 for further details.

1.5. Design Options

As mentioned above, the PSR considered widening of SR 65 from Roseville to Lincoln. When developing the initial set of project alternatives, the build alternatives included mainline widening throughout the project limits. In particular, the initial Carpool Lane Alternative had the additional mainline lane restricted to high-occupancy vehicles. The initial build alternatives were evaluated at a conceptual level. While the initial Carpool Lane Alternative showed lower travel time for HOVs, the delay for all vehicles in the network was higher. In addition, the design year peak hour demand volume in the carpool lane north of Sunset Boulevard was less than 1,000 vehicles per hour (vph). The Caltrans guideline that the carpool lane should have a peak hour volume of at least 800 vph within five years of construction would be difficult to meet for this segment. As a result, the full-length carpool lane alternative was dropped from further consideration. For further details, please see the technical memorandum on this topic in the Appendix.









The initial operations analysis using the Vissim software showed a bottleneck for the General Purpose Lane Alternative under design year AM peak hour conditions at Pleasant Grove Boulevard. As a result, a southbound through lane was added through the interchange. This lane would connect the auxiliary lanes on either side of the Pleasant Grove Boulevard interchange (see Figure 14 for the final configuration).

For the Carpool Lane Alternative, the initial operations analysis showed a bottleneck in the northbound direction at Blue Oaks Boulevard during the design year PM peak hour. At the Blue Oaks Boulevard overcrossing, northbound SR 65 was two general purpose lanes and an HOV lane compared to three general purpose lanes with the other build alternative.

To comply with air quality conformity and funding limitations, the build alternatives were modified to defer mainline widening into the median to a separate project. In the southbound direction, mainline inside widening was dropped north of the Blue Oaks Boulevard westbound on-ramp. In the northbound direction, all mainline widening into the median was removed. The inside widening is assumed to occur as a separate project to construct a general purpose lane by the 2040 design year.

LEGEND

Transportation Facility Improvements

-  New Interchange
-  Interchange Modification
-  Bridge Widening
-  Grade Separation
-  At Grade Intersection
-  New Roadway
-  Roadway Widening
-  Auxiliary Lanes
- 2 (4)** Existing Lanes (Planned Lanes)

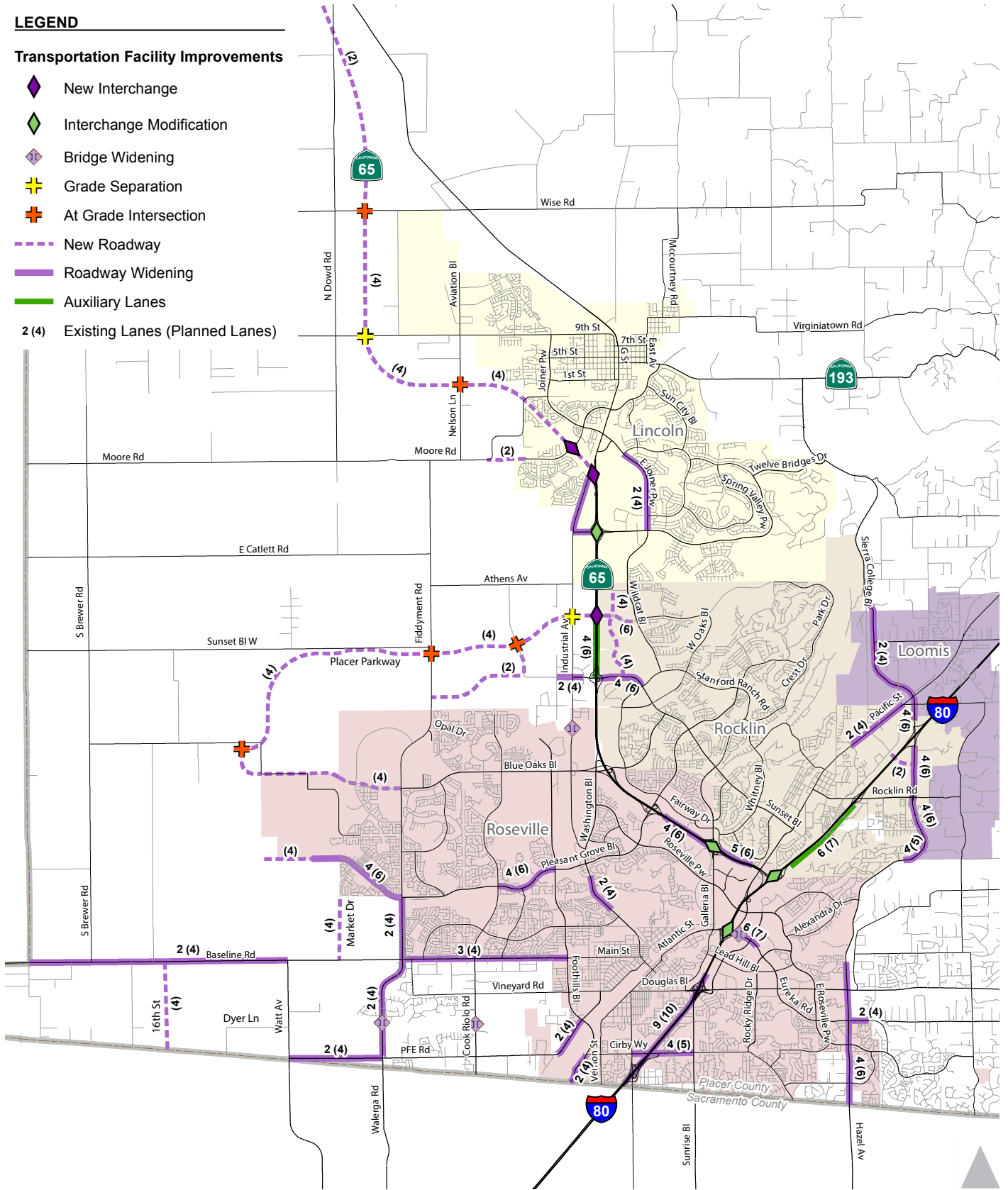











Figure 2

Roadway Improvements Assumed to be Constructed by 2020



LEGEND

Transportation Facility Improvements

-  New Interchange
-  Interchange Modification
-  Bridge Widening
-  Grade Separation
-  At Grade Intersection
-  New Roadway
-  Roadway Widening
-  Auxiliary Lanes
-  HOV Lanes
- 2 (4)** Existing Lanes (Planned Lanes)

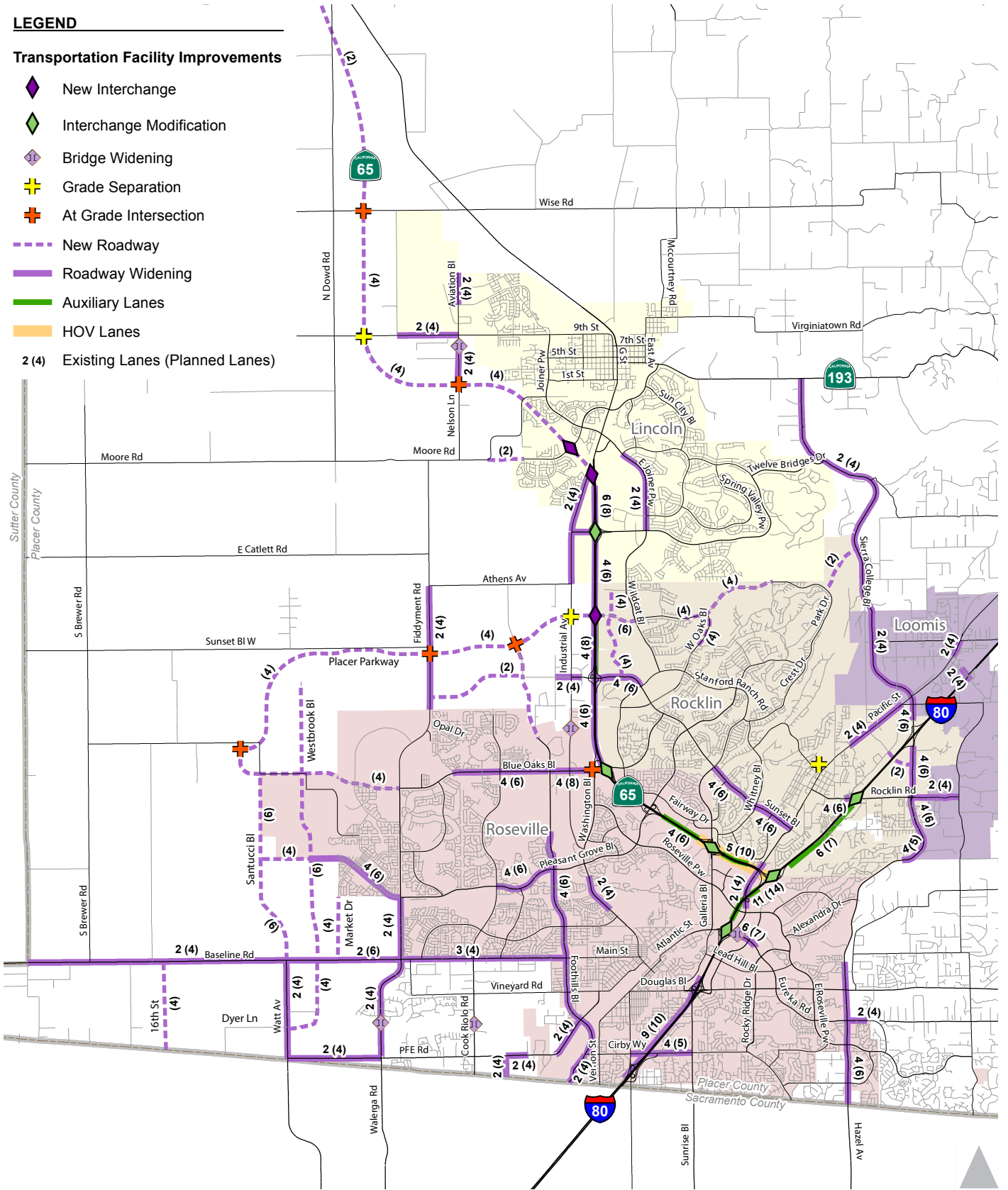

Figure 3

Roadway Improvements Assumed to be Constructed by 2040



An alternate configuration for the final Carpool Lane Alternative was tested. In this option, the lane addition starting just upstream of the Blue Oaks Boulevard westbound on-ramp would be a general purpose lane. The carpool lane would start downstream of the Blue Oaks Boulevard eastbound on-ramp. This configuration was evaluated under construction year conditions during the AM peak period. Both the regular and alternate configurations showed acceptable operations. Under design year conditions, the two configurations would be the same since the separate median widening project would construct the additional lanes. The option with the carpool lane starting farthest north was retained so that vehicles eligible for the carpool lane would have an advantage and to allow for the option of the future median widening to be a carpool lane.

Chapter 2. Analysis Methodology

2.1. Study Area

The project study area for transportation analysis extends beyond the immediate vicinity of the SR 65 corridor as shown in Figure 4. The larger study area for transportation analysis purposes was based on two key factors.

1. The area needed to be large enough to capture the influence of potential changes along the SR 65 corridor. This was determined through field observations and travel forecasting analysis that assessed traffic volume changes associated with the project's general purpose and carpool lane changes. This information revealed peak period traffic operations on SR 65 influence upstream and downstream conditions through multiple local interchanges and the adjacent I-80 corridor.
2. The Placer County Transportation Planning Agency (PCTPA) developed a travel forecasting and traffic operations model for the I-80/SR 65 Interchange Improvements project that would be used for future projects such as SR 65 Capacity and Operational Improvement project.

Depending on the analysis scenario, up to 155 individual analysis locations are included in the study area. These locations consist of freeway mainline segments, freeway ramp junctions, freeway weaving areas, and intersections. For a complete listing of all analysis locations, refer to the Technical Appendix.

2.2. Data Collection Methods

This section describes the data that were collected for use in the traffic analysis.

2.2.1. Geometric Data

Roadway geometric data were gathered using aerial photographs, design plans (for the I-80 carpool lane project through the City of Roseville), and field observations. The lane configurations that were taken initially from aerial photographs were confirmed or revised based on field observations.

LEGEND

- Mesosopic (Visum) Analysis Area
- Microscopic (Vissim) Analysis Area
- County Boundary

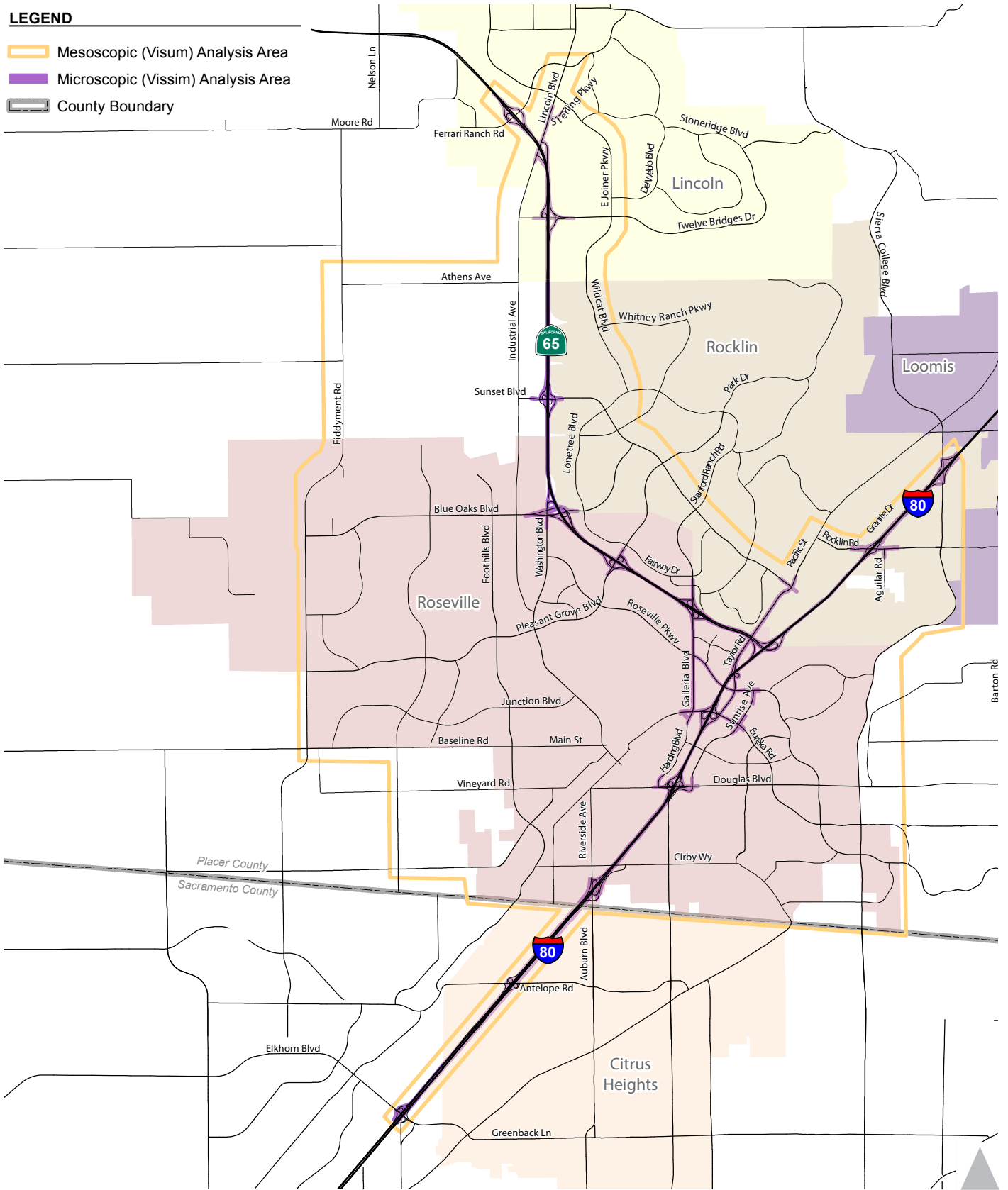

Figure 4

Study Area



2.2.2. Traffic Control Data

Traffic control data (i.e., signal phasing/timings) were provided by the responsible operating agencies including Caltrans, the City of Roseville, the City of Rocklin, and Placer County. The Caltrans Traffic Operations Sacramento Area office provided timing information for the ramp meters that were operating when the traffic counts were collected. The posted speed limits for the network were collected during field observations.

Traffic signals are modeled as either free operation or coordinated according to the control plans specified in the controller. Traffic control at unsignalized intersections were taken from aerial photographs and confirmed during field observations.

2.2.3. Traffic Flow Data

Freeway and intersection traffic counts were collected in 15-minute intervals for the 6 to 10 AM and 3 to 7 PM peak periods during January and February 2012. At intersections, cars, trucks, bicycles, and pedestrians were counted by turning movement. For freeways, traffic counts include vehicle classification by number of occupants for passenger cars and vehicle type. Table 1 contains the hourly HOV and truck percentages at the freeway gateway locations from the traffic counts (complete traffic count data are contained in the Technical Appendix).

Hour	Eastbound I-80 at Riverside Ave		Westbound I-80 at Sierra College Blvd		Southbound SR 65 at Twelve Bridges Dr	
	HOV	Truck	HOV	Truck	HOV	Truck
6 to 7 AM	12.4%	7.9%	11.6%	3.8%	13.1%	1.8%
7 to 8 AM	13.7%	3.7%	10.7%	3.8%	10.5%	1.4%
8 to 9 AM	15.6%	4.0%	13.9%	5.2%	14.8%	1.1%
9 to 10 AM	18.3%	5.3%	18.1%	5.9%	19.0%	2.2%
3 to 4 PM	20.0%	3.2%	24.3%	7.5%	31.1%	1.7%
4 to 5 PM	19.2%	2.6%	24.5%	5.1%	26.6%	0.9%
5 to 6 PM	13.9%	2.2%	18.8%	5.1%	31.0%	1.0%
6 to 7 PM	12.7%	2.8%	17.1%	5.2%	29.5%	1.5%

Source: Fehr & Peers, 2015

2.2.4. Travel Time Data

Travel time surveys were conducted during the same day of the mainline counts using global positioning system (GPS) units. The following routes were traveled for a minimum of every 15 minutes during the morning and evening peak periods.

- Southbound SR 65 at Blue Oaks Boulevard to westbound I-80 at Elkhorn Boulevard
- Eastbound I-80 at Elkhorn Boulevard to northbound SR 65 at Blue Oaks Boulevard
- Westbound I-80 from Sierra College Boulevard to Elkhorn Boulevard
- Eastbound I-80 from Elkhorn Boulevard to Sierra College Boulevard

2.3. Travel Forecasting Methodology

The transportation analysis used an integrated modeling approach that has three different levels of detail: macro, meso, and micro. At the macro level, the regional travel forecasting model (SACMET) was used to forecast peak period origin-destination (OD) traffic volume flows between traffic analysis zones both internal and external to the study area. At the meso level, the peak period OD flows were divided into four one-hour trip tables and disaggregated into three modes – single occupant vehicle (SOV), HOV, and truck – and then assigned to the sub-area roadway network using the Visum software. The assignment process was based on congested travel times that reflect roadway link speeds and capacity. At the micro level, the traffic volumes were converted to individual vehicles that were assigned to the operational study area using the Vissim software that contains detailed inputs governing traffic controls (signal timings), geometrics (lane configurations), and driver behavior.

The traffic forecasts were developed using the first two modeling platforms (macro and meso). The first platform is a modified version of the regional SACMET model developed by the Sacramento Area Council of Governments (SACOG) for the Metropolitan Transportation Plan (MTP)/Sustainable Communities Strategy (SCS). The second platform is the Visum sub-area trip assignment model, which was used to assign the trips generated from the SACMET model to a detailed roadway network within the study area. Figure 4 above shows the mesoscopic and microscopic analysis areas.

The SACMET and Visum models were calibrated and validated according to the *2010 California Regional Transportation Guidelines* (California Transportation Commission, 2010) and criteria approved by the PDT. Both models passed applicable static and dynamic validation tests. The detailed validation results are contained in Chapter 4 of the *I-80/SR 65 Interchange Improvements Transportation Analysis Report* (August 2014).

Traffic volume forecasts were developed for construction year (2020) and design year (2040) conditions. The forecasts relied on modified inputs to the MTP/SCS SACMET model based on refinements by the I-80/SR 65 Interchange Improvements PDT to land use projections and the planned roadway network as explained below.

2.3.1. Socioeconomic Forecasts

The traffic volume forecasts are derived from future socioeconomic projections that started with regional socioeconomic projections developed by SACOG for the regional MTP/SCS. These were reviewed by the I-80/SR 65 Interchange Improvements PDT and modified to better reflect local plans. Figure 5 displays the final growth projections within the study area. Socioeconomic projections are the largest single influence on traffic volume forecasts, so they will affect volume projections to a greater extent than the roadway network changes or any other modeling component. If these forecasts vary in reality, it will have a direct effect on future traffic volumes.

2.3.2. Planned Transportation Network

The traffic volume forecasts (and operations analysis) are influenced by modifications to the existing transportation network according to improvement projects anticipated to be constructed by the construction and design years (refer to Figures 2 and 3). These projects are based on the financially constrained project list contained in the MTP/SCS, but also consider projects the I-80/SR 65 Interchange Improvements PDT agreed would likely be constructed by the design year. The rationale for adding projects to the MTP/SCS list was that the design year is five years beyond the 2035 horizon of the MTP/SCS. This creates a longer timeframe for revenue to accumulate. Further, the additional socioeconomic growth added to the model would also be contributing to transportation revenue to help pay for these improvements.

A list of the planned projects is provided in Table 2. Related projects are shown in bold. The SR 65/Galleria Boulevard Interchange Improvements Phase II project area overlaps with the Stanford Ranch Road/SR 65 Northbound Ramps project. For this analysis, the Phase II project is assumed to cover only improvements at the Stanford Ranch Road/Fairway Drive intersection (a third northbound through lane and a northbound right-turn lane). Descriptions of the projects located in the analysis area are provided below.

As discussed above, the separate project to widen into the median north of Blue Oaks Boulevard in the southbound direction and north of Pleasant Grove in the northbound direction was originally part of the proposed project. The forecasts for design and construction years were developed with these definitions of the project alternatives. To minimize disruption to the project development process, the forecasts were not updated when the build alternatives were revised since the design year network changes would be minor for the build alternatives and would generate higher volumes for the no build alternative. So,

revising the forecasted volumes would have shown about the same impacts for the build alternatives and worse conditions for the no build alternative. This outcome was verified with a test of the forecast models.

The unadjusted forecast model volumes were prepared for the final project alternatives and compared with the original unadjusted model volumes. For Alternative 1, the AM and PM peak hour volumes were less than 100 vph higher between Stanford Ranch Road/Galleria Boulevard and Pleasant Grove Boulevard in both directions. For Alternative 2, the AM and PM peak hour volumes at the same location were about 100 vph lower in the southbound direction and less than 50 vph lower in the northbound direction. The differences are largely due to changes in location of the HOV lane.

For the No Build Alternative, the volume difference in the southbound direction was similar to the differences for Alternative 1. In contrast, the northbound direction had much higher volumes – 550 to 750 vph higher during the AM and PM peak hours, respectively. These higher volumes would generate even worse levels of congestion than are reported below in Chapter 5.

2.4. Traffic Operations Analysis Methodology

Because the study area already experiences peak period congestion, which is forecast to worsen, the traffic operations analysis required the use of simulation-based analysis. A congested network is very sensitive to any change in capacity or demand and the analysis tools need to be able to capture how changes in one location of the network affect the overall performance. Therefore, a Vissim traffic simulation model was developed as follows.

- The model was constructed from roadway network (lane configuration), traffic volume (traffic counts), and traffic control (traffic signal and ramp meter) data.
- Additional detail was incorporated into the Vissim network (posted speed limits, grades, etc.) to reflect observed field conditions.

LEGEND

Analysis District

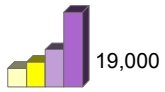

- 2008 Households
- 2035 Households
- 2008 Total Employment
- 2035 Total Employment

Not to Scale

Analysis District Totals	
78,281	2008 Households
127,076	2035 Households
+ 48,795	
97,746	2008 Employment
163,882	2035 Employment
+ 66,136	
20,383	2008 Students
40,500	2035 Students
+ 20,117	

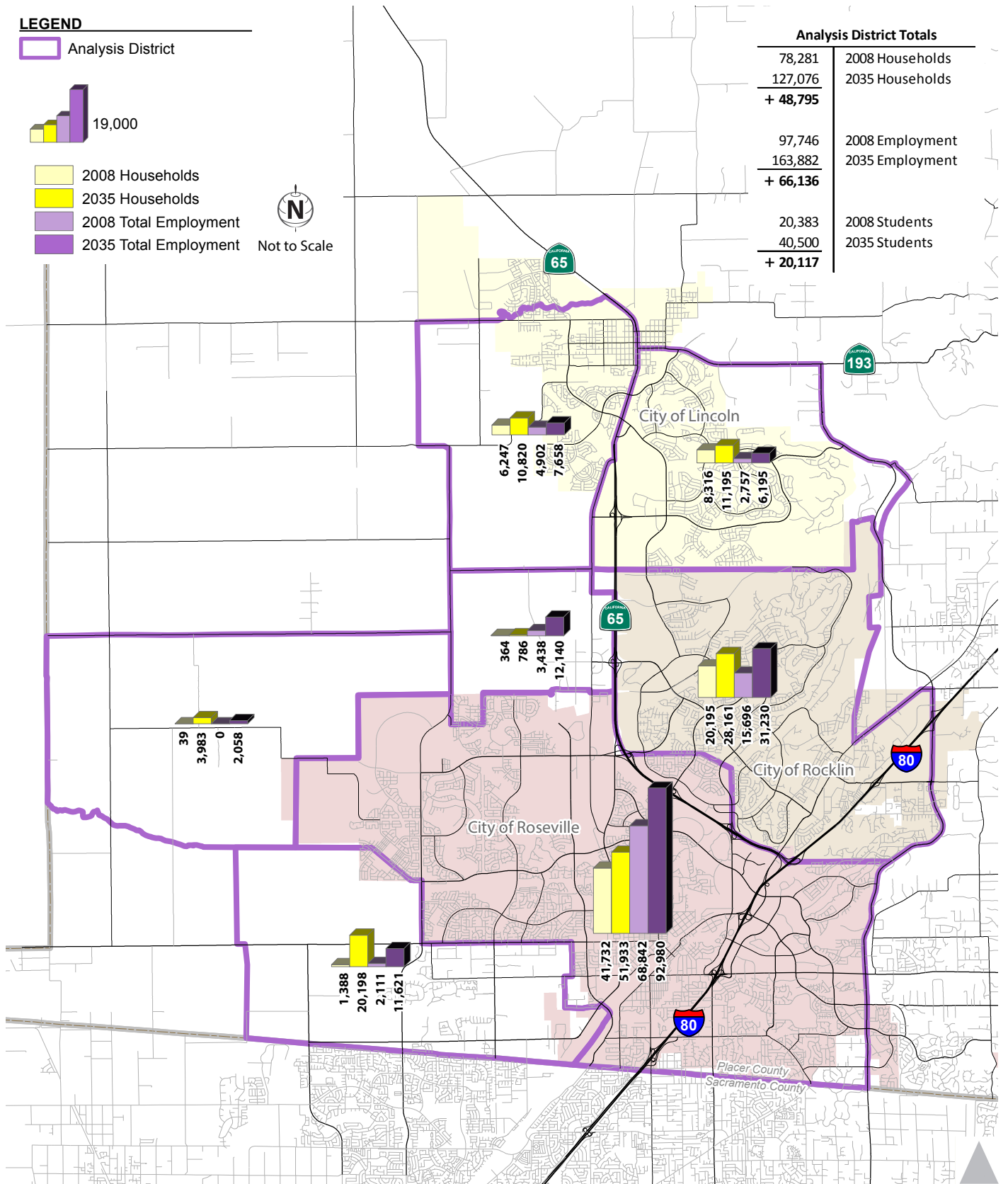

Figure 5

Modified SACMET Land Use Summary by Analysis District



TABLE 2: PLANNED SEPARATE PROJECTS

Category	Project
Complete by 2020 (Construction Year)	<ul style="list-style-type: none"> • Atkinson St: widen from 2 to 4 lanes from Foothills Blvd to south of Dry Creek • Baseline Rd: widen from 3 to 4 lanes from Brady Ln to Fiddymnt Rd • Baseline Rd: widen from 2 to 4 lanes from Fiddymnt Rd to Watt Ave • Baseline Rd: widen from 2 to 4 lanes from Watt Ave to (future) 16th St • Baseline Rd: widen from 2 to 4 lanes from (future) 16th St to county line • Blue Oaks Blvd: construct 4 lanes from Fiddymnt Rd to Hayden Pkwy and 2 lanes from Hayden Pkwy to Westbrook Blvd • Blue Oaks Blvd: widen from 2 to 4 lanes from Hayden Pkwy to Westbrook Blvd and construct 4 lanes from Westbrook Blvd to Santucci Blvd • Blue Oaks Blvd/Washington Blvd widening • Cirby Way: widen from 4 to 5 lanes from Riverside Ave to Regency Ave • Cook Riolo Rd: widen from 1 to 2 lanes Dry Creek Bridge • Domiguez Rd: construct 2 lanes from Granite Dr to Sierra College Blvd • East Joiner Pkwy: widen from 2 to 4 lanes from Del Webb Pkwy to Twelve Bridges Dr • Eureka Rd: widen from 2 to 4 lanes from Sierra College Blvd to city limits • Ferrari Ranch Rd: construct 2 lanes from city limit to Moore Rd • Fiddymnt Rd: widen to 4 lanes from Pleasant Grove Blvd to Baseline Rd • I-80/Eureka Rd On-ramp Improvements • I-80/SR 65 Interchange Improvements Phase 1 • Industrial Ave: widen from 2 to 4 lanes from SR 65 to Twelve Bridges Dr • Industrial Ave: replace 2 lane bridge at Pleasant Grove Creek • Market St: construct 2 lanes from Baseline Road to Pleasant Grove Blvd • Pacific St: widen to 4 lanes from Sierra Meadows Dr to Loomis town limits • PFE Rd: widen from 2 to 4 lanes from Watt Ave to Walerga Rd • Placer I-80 Auxiliary Lanes: Eastbound Auxiliary Lane and Westbound 5th Lane Alternative • Placer Pkwy: construct 4-lane expressway from SR 65 to Santucci Blvd • Pleasant Grove Blvd: widen from 4 to 6 lanes from Foothills Blvd to Woodcreek Oaks Blvd • Pleasant Grove Blvd: widen from 2 to 4 lanes from Fiddymnt Road to Santucci Blvd • Rocklin Rd: widen from 4 to 6 lanes from Granite Dr to I-80 Westbound Ramps • Roseville Rd: widen from 2 to 4 lanes from city limits to Cirby Way • Santucci Blvd: construct 4 lanes from Baseline Road to Blue Oaks Blvd • Sierra College Blvd: widen to 6 lanes from county line to Olympus Dr • Sierra College Blvd: widen from 4 to 5 lanes from Nightwatch Dr to Aguilar Tributary • Sierra College Blvd: widen from 4 to 6 lanes from Aguilar Tributary to I-80 • Sierra College Blvd: widen from 4 to 6 lanes from Granite Dr to Bankhead Rd • Sierra College Blvd: widen from 2 to 4 lanes from Taylor Rd to north town limits • SR 65 Lincoln Bypass – Phase 1 & 2A • SR 65/Ferrari Ranch Rd Interchange • SR 65/Whitney Ranch Pkwy: construct interchange • Stanford Ranch Road/Northbound SR 65 Ramps • Sunset Blvd: construct 2 lanes from Fiddymnt Rd to Foothills Blvd • Sunset Blvd: widen from 2 to 4 lanes from Cincinnati Ave to SR 65 • Sunset Blvd: widen to 6 lanes from SR 65 to West Stanford Ranch Rd • Twelve Bridges Dr: widen from 2 to 4 lanes from Industrial Ave to SR 65 including interchange • University Ave: construct 4 lanes from Sunset Blvd to Ranch View Dr • Walerga Rd: widen from 2 to 4 lanes from Baseline Rd to county line • Washington Blvd: widen to 4 lanes from Sawtell Rd to Pleasant Grove Blvd • Whitney Ranch Pkwy: construct 6 lanes from SR 65 to east of Wildcat Blvd

TABLE 2: PLANNED SEPARATE PROJECTS	
Category	Project
Complete by 2035	<ul style="list-style-type: none"> • Aviation Blvd: widen from 2 to 4 lanes from Venture Dr to 0.5 mi north of Venture Dr • Dyer Ln: construct 4 lanes from Watt Ave to Baseline Rd • Fiddymt Rd: widen from 2 to 4 lanes from Roseville city limits to Athens Rd • Foothills Blvd: construct 2 lanes from Roseville city limits to Sunset Blvd • I-80/Horseshoe Bar Rd Interchange: widen overcrossing from 2 to 4 lanes • I-80/Rocklin Rd Interchange improvements • Industrial Ave: widen from 2 to 4 lanes from Twelve Bridges Dr to Athens Ave • Nicolaus Rd: widen from 2 to 4 lanes from Airport Rd to Aviation Blvd • Midas Ave: construct grade separation at UPRR • Rocklin Rd: widen from 2 to 4 lanes from Sierra College Blvd to Loomis town limits • Rocklin Rd: widen from 2 to 4 lanes from west Loomis town limits to Barton Rd • North Antelope Rd: widen from 2 to 4 lanes from county line to PFE Rd • Sierra College Blvd: widen from 2 to 4 lanes from SR 193 to Loomis town limits • Sierra College Blvd: widen to 4 lanes from (future) Valley View Pkwy to Loomis town limits • SR 65/Blue Oaks Blvd Interchange Improvements • SR 65/Galleria Blvd Interchange Improvements (Phase II)¹ • Sunset Blvd: widen from 4 to 6 lanes from Stanford Ranch Rd to Topaz Ave • Sunset Blvd: widen from 4 to 6 lanes from Topaz Ave to Whitney Blvd • Sunset Blvd: widen from 4 to 6 lanes from Whitney Blvd to Pacific St • Taylor Rd: widen from 2 to 4 lanes from Horseshoe Bar Rd to King Rd • Valley View Pkwy: construct 2 lanes from Park Dr to Sierra College Blvd • West Oaks Blvd: construct 4 lanes from terminus to (future) Whitney Ranch Pkwy • Whitney Ranch Pkwy: construct 4 lanes from terminus to Whitney Oaks Dr • Watt Ave: widen from 2 to 4 lanes from Baseline Rd to county line
Assumed to be Complete by 2040 (Design Year)	<ul style="list-style-type: none"> • Baseline Rd: widen from 4 to 6 lanes from Fiddymt Rd to Watt Ave • Blue Oaks Blvd: widen to 6 lanes from Crocker Ranch Rd to Foothills Blvd • Blue Oaks Blvd: widen to 8 lanes from Foothills Blvd to Washington Blvd • Foothills Blvd: widen to 6 lanes from Cirby Way to Misty Wood Dr • I-80/SR 65 Interchange Improvements: Collector-Distributor System Ramps Alternative • Nelson Ln: widen from 2 to 4 lanes from SR 65 (Lincoln Bypass) to Nicolaus Rd • PFE Rd: widen from 2 to 4 lanes from North Antelope Rd to Roseville city limits • Santucci Blvd: construct 6 lanes from Baseline Road to Blue Oaks Blvd • SR 65 Widening from Pleasant Grove Blvd to Ferrari Ranch Rd • Taylor Rd: widen from 2 to 4 lanes from Roseville Pkwy to I-80 • Taylor Rd: widen from 2 to 4 lanes from I-80 to city limits • Westbrook Blvd: construct new road from Baseline Rd to Pleasant Grove Blvd • Westbrook Blvd: construct new road from Pleasant Grove Blvd to Blue Oaks Blvd • Westbrook Blvd: construct new road from Blue Oaks Blvd to city limits
<p>Note: 1. Stanford Ranch Road/Fairway Drive improvements only.</p> <p>Sources: SACOG, 2012 and Fehr & Peers, 2015</p>	

- Driver behavior parameters were adjusted based on field observations.
- The distribution of vehicle types was calibrated to local conditions so that the percentages of trucks and HOVs match the traffic counts.

The Vissim model was validated to existing conditions using the criteria contained in *Traffic Analysis Toolbox Volume III: Guidelines for Applying Traffic Microsimulation Modeling Software* (Federal Highway Administration, 2004). The default Vissim parameters for geometrics and driver behavior were iteratively adjusted until the model was validated to observed conditions (refer to the Technical Appendix for a complete summary of the Vissim model validation). Since microsimulation models, like Vissim, rely on the random arrival of vehicles, multiple runs are needed to provide a reasonable level of statistical accuracy and validity. Therefore, the results of 10 separate runs (each using a different random seed number) were averaged to determine the final results.

The calibrated and validated model was used to generate a variety of traffic operations performance measures including person throughput, vehicle throughput, vehicle delay, passenger car density, travel time, speed, and percent demand served. Some of these measures were used to determine level of service (LOS) values for analysis locations consistent with the methodology contained in the *Highway Capacity Manual* (HCM) (Transportation Research Board, 2011).

The HCM methods use quantitative performance measures to determine LOS for analysis locations under AM and PM peak hour conditions. LOS is a qualitative measure of traffic operations from a driver's perspective, which varies from LOS A (the best) to LOS F (the worst), and is one of the main evaluation criteria for this study. Tables 3 and 4 describe the LOS thresholds from the HCM for freeway sections and signalized intersections, respectively.

To analyze construction year and design year conditions, Vissim models were built for each alternative based on the calibrated/validated existing conditions model. The network changes for each alternative were coded into the respective models. All models included separately planned projects (listed in Table 2) that were located in the microsimulation analysis area.

The roadway assumptions for the separately planned projects are listed below.

- Blue Oaks Boulevard Widening (design year only) – widening of the eastbound approach to Washington Boulevard to four lanes
- Blue Oaks Boulevard/Washington Boulevard Widening – widening of Washington Boulevard to provide a second northbound right turn pocket lane

TABLE 3: FREEWAY LOS THRESHOLDS			
LOS	Average Density (vplpm)		Description
	Basic Sections	Ramp Junction & Weave Sections	
A	< 11	< 10	Free-flow speeds prevail. Vehicles are almost completely unimpeded in their ability to maneuver.
B	> 11 to 18	> 10 to 20	Free-flow speeds are maintained. The ability to maneuver with the traffic stream is only slightly restricted.
C	> 18 to 26	> 20 to 28	Flow with speeds at or near free-flow speeds. Freedom to maneuver within the traffic stream is noticeably restricted, and lane changes require more care and vigilance on the part of the driver.
D	> 26 to 35	> 28 to 35	Speeds decline slightly with increasing flows. Freedom to maneuver with the traffic stream is more noticeably limited, and the driver experiences reduced physical and psychological comfort.
E	> 35 to 45	> 35 to 43	Operation at capacity. There are virtually no usable gaps within the traffic stream, leaving little room to maneuver. Any disruption can be expected to produce a breakdown with queuing.
F	> 45	> 43	Represents a breakdown in flow.

Notes: vplpm = vehicles per lane per mile
 Source: Fehr & Peers, 2015

TABLE 4: SIGNALIZED INTERSECTION LOS THRESHOLDS		
LOS	Average Delay (sec/veh)	Description
A	< 10	Very low delay occurs with favorable progression and/or short cycle length.
B	> 10 to 20	Low delay occurs with good progression and/or short cycle lengths.
C	> 20 to 35	Average delays result from fair progression and/or longer cycle lengths. Individual cycle failures begin to appear.
D	> 35 to 55	Longer delays occur due to a combination of unfavorable progression, long cycle lengths, or high volume-to-capacity ratios. Many vehicles stop and individual cycle failures are noticeable.
E	> 55 to 80	High delay values indicate poor progression, long cycle lengths, and high volume-to-capacity ratios. Individual cycle failures are frequent occurrences. This is considered to be the limit of acceptable delay.
F	> 80	Delays are unacceptable to most drivers due to over-saturation, poor progression, or very long cycle lengths.

Notes: sec/veh = seconds per vehicle
 Source: Fehr & Peers, 2015

- I-80/Eureka Road On-ramp Improvements – widening westbound Eureka Road from Sunrise Avenue to Taylor Road and the westbound to eastbound on-ramp to I-80 (project completed in 2013)
- I-80/Rocklin Road Interchange (design year only) – widening Rocklin Road to six lanes from Granite Drive to Aguilar Road, with dual left-turn lanes eastbound at Granite Drive, westbound at westbound I-80, and eastbound at eastbound I-80²
- I-80/SR 65 Interchange Improvements Phase 1 (construction year only) – adding a lane to the westbound I-80 to northbound SR 65 connector ramp, the northbound SR 65 mainline from the I-80 westbound connector ramp to Pleasant Grove Boulevard, and the southbound SR 65 mainline from the Pleasant Grove Boulevard westbound on-ramp to the Galleria Boulevard overcrossing³
- I-80/SR 65 Interchange Improvements (design year only) – reconfiguring the interchange to provide a direct connector for the eastbound to northbound movement, widening of all connector ramps by one lane, adding median HOV-only connector ramps from eastbound to northbound and southbound to westbound, widening of SR 65 from I-80 to Pleasant Grove Boulevard, widening of Taylor Road to four lane between Roseville Parkway and the Rocklin city limits, adding a collector-distributor roadway on eastbound I-80 between Eureka Road and SR 65, and widening of westbound I-80 between SR 65 at Atlantic Street
- Placer I-80 Auxiliary Lanes – adding a fifth lane to westbound I-80 from the westbound Douglas Boulevard off-ramp to the Riverside Avenue northbound on-ramp, adding an eastbound I-80 lane from the lane drop east of SR 65 to the deceleration lane at the Rocklin Road off-ramp, and widening of the Rocklin Road eastbound off-ramp to two lanes
- Stanford Ranch Road/SR 65 Northbound Ramps – reconfiguring the northbound ramp terminal intersection to control all movements at the signal and adding a second northbound left-turn lane, a third northbound through lane, a second eastbound right-turn lane, and a southbound right turn pocket lane
- SR 65 Lincoln Bypass Phase 1 – realigning SR 65 and constructing the Lincoln Boulevard and Ferrari Ranch Road interchanges (project completed in 2013)
- SR 65/Twelve Bridges Drive Interchange – widening Twelve Bridges Drive from one to two through lanes in both directions, widening the southbound off-ramp to provide a second left-turn pocket lane, and widening the northbound on-ramp to provide an HOV preferential lane

² This configuration is based on one of the alternatives developed for the I-80/Rocklin Road Interchange PSR. In the meantime, the City of Rocklin has moved ahead with plans to construct a roundabout at Rocklin Road/Granite Drive by the construction year of 2020. Since this occurred after the start of this project, the planned roundabout is not included.

³ Funding for this project was secured after the forecasts were prepared, so the project is only included in the Vissim operational models.

- SR 65/Placer Parkway/Whitney Ranch Parkway Interchange – constructing a partial cloverleaf interchange with connections to Whitney Ranch Parkway to the east and Placer Parkway to the west and auxiliary lanes to and from Sunset Boulevard to the south
- SR 65 Widening from Pleasant Grove Boulevard to Ferrari Ranch Road (design year only) – widening to provide an additional general purpose lane northbound from south of Pleasant Grove Boulevard off-ramp to Ferrari Ranch Road and southbound from Ferrari Ranch Road to south of the Blue Oaks Boulevard off-ramp⁴
- Sunset Boulevard Widening (design year only) – widening of Sunset Boulevard at Pacific Street to provide a third northbound and eastbound left-turn lanes and a second southbound right-turn lane.

2.5. Evaluation Criteria

The analysis evaluation criteria from the I-80/SR 65 Interchange Improvements project are applied to this project since the study area is the same. The criteria were developed in collaboration with the PDT because the project has the potential to affect traffic operations across multiple jurisdictions. The main criteria used for this study is LOS as described below since each affected agency has establish policies and thresholds related to LOS expectations.

According to the *Interstate 80 and Capital City Freeway Corridor System Management Plan* and the *State Route 65 Corridor System Management Plan* (Caltrans District 3, May 2009), Caltrans has identified the route concept LOS for the following segments.

- LOS F for I-80 from Riverside Avenue/Auburn Boulevard to Sierra College Boulevard
- LOS F for SR 65 from I-80 to Blue Oaks Boulevard
- LOS E for SR 65 from Blue Oaks Boulevard to Industrial Avenue (Lincoln Boulevard)

LOS E conditions are desired when feasible but LOS F conditions are likely to occur in the study area under no build conditions as recognized by the concept LOS thresholds. The LOS E threshold will be used to identify minimum acceptable operations (that is, deficiencies) and potential impacts to State highway mainline segments, ramp junctions, and weaving segments. For locations with LOS F under the no build condition, an impact would occur if the project alternatives would worsen the LOS F condition based on the quantitative performance measure associated with the specific type of analysis.

⁴ This project was originally part of the SR 65 Capacity and Operational Improvements project. The project was assumed to be a general purpose lane to be consistent with the initial operations analysis, which had a general purpose lane for most of the project length.

For study intersections within the City of Lincoln, the City of Lincoln General Plan (Adopted March 2008) contains the following LOS policies:

- Strive to maintain a LOS C at all signalized intersections in the City during the PM peak hours.
- The City shall coordinate with Caltrans in order to strive to maintain a minimum LOS “D” for SR 65 and SR 193.

With the construction of the SR 65 bypass, the analysis locations on Lincoln Boulevard in Lincoln are local intersections. As a result, LOS C will serve as the minimum acceptable LOS for the intersections on Lincoln Boulevard and Twelve Bridges Drive for both AM and PM peak hours.

For study intersections within the City of Roseville, the City of Roseville General Plan (Adopted May 5, 2010) LOS policy states:

- Maintain a level of service (LOS) “C” standard at a minimum of 70 percent of all signalized intersections and roadway segments in the City during the PM peak hours.

Some of the study intersections are shown in the General Plan to operate at worse than LOS C under 2025 conditions. For this project, the following criteria are proposed.

- For intersections shown to be operating at LOS C or better in the General Plan under 2025 conditions, LOS C will be used as the minimum acceptable LOS.
- For intersections shown to be operating at LOS D in the General Plan under 2025 conditions, LOS D will be used as the minimum acceptable LOS.
- For intersections shown to be operating at LOS E in the General Plan under 2025 conditions, LOS E will be used as the minimum acceptable LOS.
- For intersections shown to be operating at LOS F in the General Plan under 2025 conditions, LOS F and the corresponding delay will be used as the minimum acceptable LOS.

Using the above criteria, the Stanford Ranch Road/SR 65 Northbound Ramps, Galleria Boulevard/SR 65 Southbound Ramps, Roseville Parkway/Taylor Road, and Douglas Boulevard/Sunrise Avenue intersections will have a LOS D threshold, and the Galleria Boulevard/Roseville Parkway, Roseville Parkway/Sunrise Avenue, Eureka Road/Taylor Road/I-80 Eastbound Ramps, and Douglas Boulevard/Harding Boulevard intersections will have a LOS E threshold. All other Roseville intersections will have a LOS C threshold. These thresholds will be used for both the AM and PM peak hours in both the construction and design year analysis.

For study intersections within the City of Rocklin, the City of Rocklin General Plan (October 2012), Policy C-10 states (in part):

- Maintain a minimum traffic Level of Service “C” for all signalized intersections during the p.m. peak hour on an average weekday

Based on this standard and for the purposes of this study, LOS C is the minimum acceptable LOS for intersections in the City of Rocklin during both AM and PM peak hours.

For this report, a project impact must satisfy two conditions. First, the study location must operate at a worse LOS than the threshold identified above. Second, the study location must operate at a worse condition (higher delay for intersections or higher density for freeway segments) than the similar case for Alternative 3 (No Build).

Chapter 3. Existing (2012) Conditions

The existing conditions analysis includes meso-scale network performance, micro-scale traffic operations, and traffic safety. The meso-scale network performance evaluates the entire network within the meso-scale study area based on vehicle miles of travel (VMT), vehicle hours of travel (VHT), vehicle hours of delay (VHD), and freeway VHD. VHD includes all hours of travel below the free-flow speed (for example, the free-flow speed on freeways is 65 miles per hour). Freeway VHD includes only hours of freeway travel below 35 miles per hour (mph). The operations analysis is more detailed and analyzes individual facilities with separate discussions for freeways and arterial intersections. The traffic safety evaluation focuses on freeway facilities.

3.1. Meso-Scale Network Performance

Table 5 contains estimates of existing (2012) meso-scale study area VMT, VHT, VHD, and Freeway VHD for AM and PM peak period conditions. This information shows that the PM peak period has the highest level of travel with VHD equal to almost 35 percent of all VHT. The AM peak period also experiences congested conditions with a VHD at approximately 25 percent of all VHT.

Measure of Effectiveness	AM Peak Period (6:00 to 10:00)	PM Peak Period (3:00 to 7:00)	AM & PM Peak Periods
VMT	1,182,073	1,562,794	2,744,867
VHT	31,314	49,967	81,281
VHD	7,807	17,423	25,230
Freeway VHD	1,459	4,564	6,023

3.2. Traffic Operations

Traffic operations were analyzed for existing (2012) conditions under AM and PM peak period and peak hour conditions. This analysis relied on the AM and PM four-hour, peak period Vissim models from which peak hour results were extracted. The Vissim model only includes the freeway network and the immediate arterial network around the I-80/SR 65 interchange. As a result, performance measures such as VMT and VHT reported from this model will contain much smaller values compared to the larger meso-scale network results presented in Table 5. Overall traffic operations performance of the micro-scale network is summarized in Table 6.

Measure of Effectiveness	AM Peak Period (6:00 to 10:00)	PM Peak Period (3:00 to 7:00)
VMT	645,270	730,100
VHT	13,760	16,850
VHD	2,670	3,950
Average Travel Speed (mph)	46.9	43.3

Similar to the Table 5 results, the PM peak period has the highest level of travel and delay with the most congestion lasting up to three hours for select segments.

3.2.1. Freeway Operations

Detailed freeway operations were analyzed for the entire four-hour AM and PM peak periods. The AM (7:30 to 8:30) and PM (4:30 to 5:30) peak hour results are reported in this section and reflect conditions based on estimates of peak hour freeway mainline and ramp traffic volumes for 2012 conditions shown in Figure 6. The existing conditions analysis confirmed field observations and provided some insight as to specific bottleneck locations, causes, and duration. Figure 7 and 8 below show the PM peak hour queue extending back from the eastbound I-80 on-ramp junction with the northbound SR 65 connector.

The existing (2012) conditions analysis of freeway and arterial performance matched observed conditions such as those shown in the photos above. Specific examples are listed below.

- Bottleneck areas have poor LOS results as highlighted in Table 7, which contains select LOS results for freeway operations. See the Appendix for all study location results.

The speed contour maps of the SR 65 and I-80 corridors produced from the Vissim models show reduced speeds in bottleneck areas (see Figures 9 through 12 below).

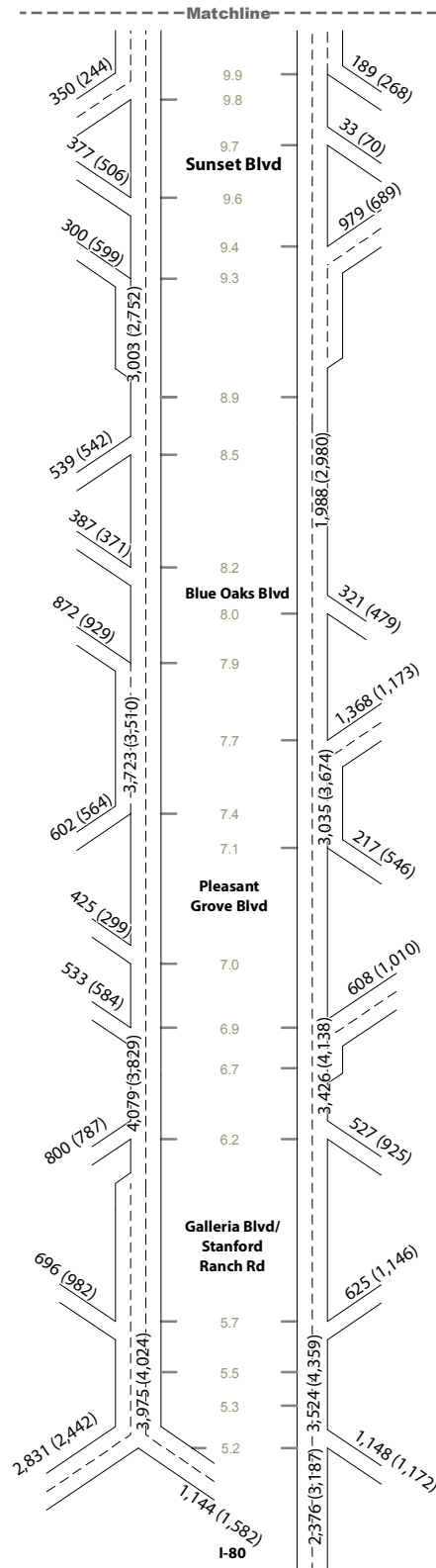
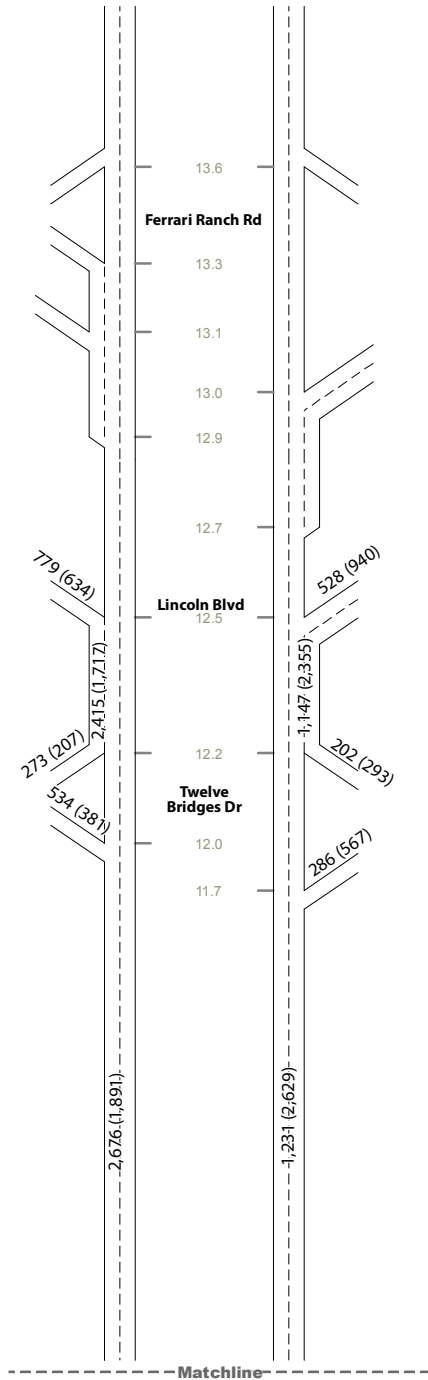

LEGEND

- AM (PM) Peak Hour Total Volume
- HOV AM (PM) Peak Hour HOV Volume
- 10.1 Postmile

Note: Traffic volumes collected in February 2012.

Figure 6

Peak Hour Traffic Volumes and Lane Configurations - Existing Conditions





Figure 7 – Eastbound I-80 from Taylor Road Overcrossing (PM Peak Hour)

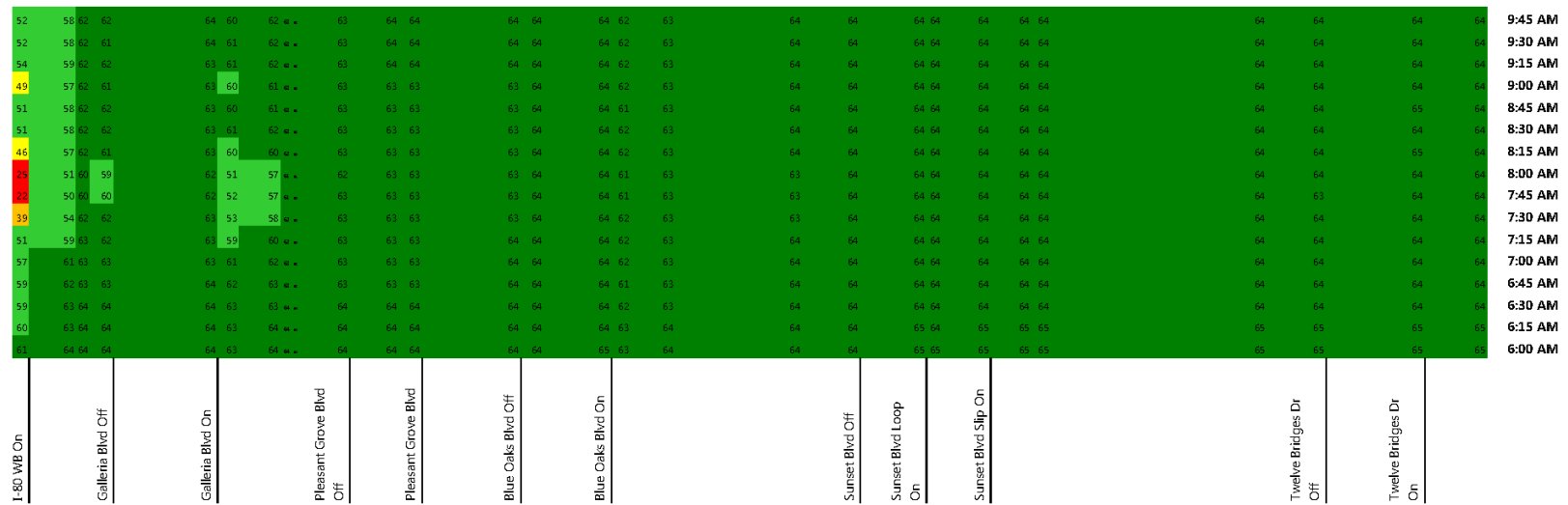

Figure 8 – Eastbound I-80 from Roseville Pkwy Overcrossing (PM Peak Hour)

TABLE 7: SELECTED FREEWAY OPERATIONS RESULTS – EXISTING (2012) CONDITIONS				
Freeway	Location	Type	AM Peak Hour	PM Peak Hour
NB SR 65	I-80 WB On-ramp	Merge	<u>F / 53</u>	<u>F / 95</u>
	I-80 to Stanford Ranch Rd	Basic	D / 32	<u>F / 77</u>
	Stanford Ranch Rd Off-ramp	Diverge	D / 33	<u>F / 62</u>
SB SR 65	Blue Oaks Blvd WB On-ramp	Merge	<u>F / 60</u>	B / 20
	Blue Oaks Blvd to Pleasant Grove Blvd	Weave	<u>F / 75</u>	C / 21
	Pleasant Grove Blvd Off to On-ramp	Basic	<u>F / 89</u>	C / 25
	Pleasant Grove Blvd WB On-ramp	Merge	<u>F / 72</u>	D / 31
	Pleasant Grove Blvd EB On-ramp	Merge	<u>F / 53</u>	E / 39
	Pleasant Grove Blvd to Galleria Blvd	Basic	E / 36	D / 32
	Galleria Blvd Off-ramp	Diverge	E / 35	D / 32
EB I-80	Eureka Rd Off-ramp	Diverge	C / 26	<u>F / 46</u>
	Eureka Rd Off to On-ramp	Basic	C / 21	C / 23
	Eureka Rd EB On-ramp	Merge	B / 19	B / 20
	Eureka Rd to Taylor Rd	Weave	C / 23	E / 42
	Taylor Rd to SR 65	Basic	D / 28	E / 42
	SR 65 Off-ramp	Diverge	C / 28	<u>F / 52</u>
WB I-80	SR 65 Off-ramp	Diverge	B / 18	E / 35
	Douglas Blvd Off-ramp	Diverge	D / 32	C / 26
	Douglas Blvd WB On-ramp	Merge	E / 36	D / 34
	Douglas Blvd EB On-ramp	Merge	E / 42	E / 37
	Douglas Blvd to Riverside Ave	Basic	D / 33	D / 31
	Riverside Ave Off-ramp	Diverge	E / 40	E / 36
Note:	Bold and underline font indicate LOS F conditions. The level of service and average density for the study segment are reported.			
Source:	Fehr & Peers, 2015			

During the AM peak hour, congested LOS F conditions occur on northbound SR 65 at the I-80 on-ramp and southbound SR 65 between Blue Oaks Boulevard and Pleasant Grove Boulevard. On northbound SR 65, the merging of the westbound I-80 on-ramp causes congestion. For southbound SR 65, the constraint is the high demand from the mainline combined with the Pleasant Grove Boulevard on-ramp volume.

AM PEAK PERIOD



PM PEAK PERIOD

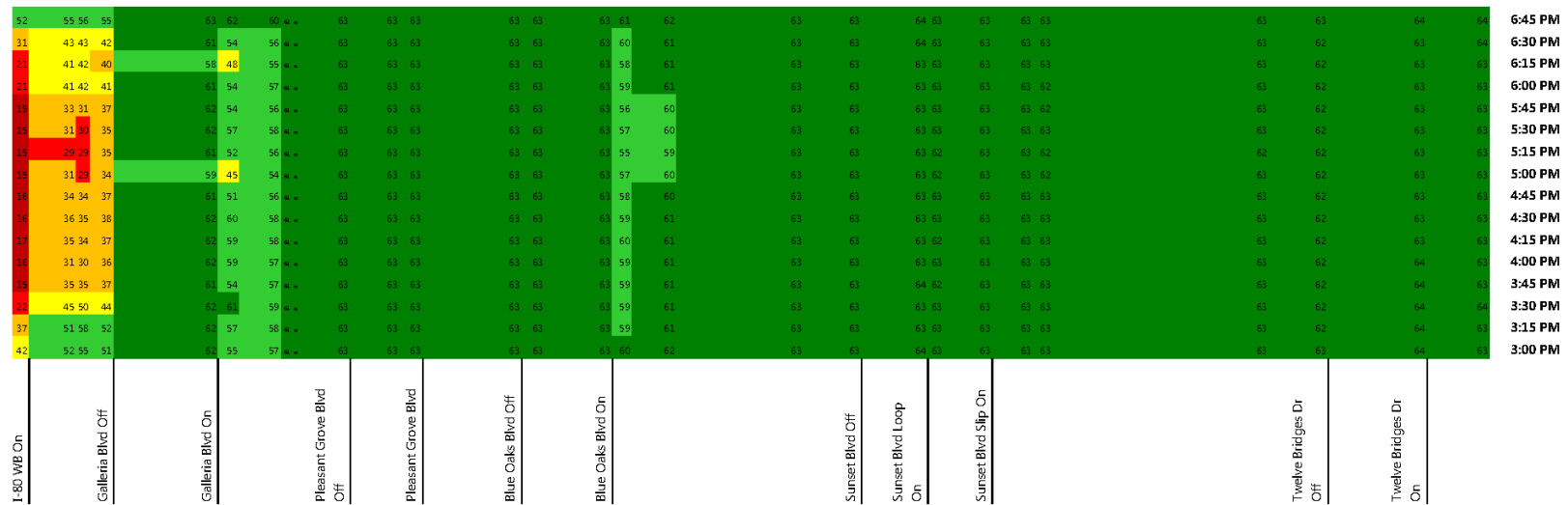
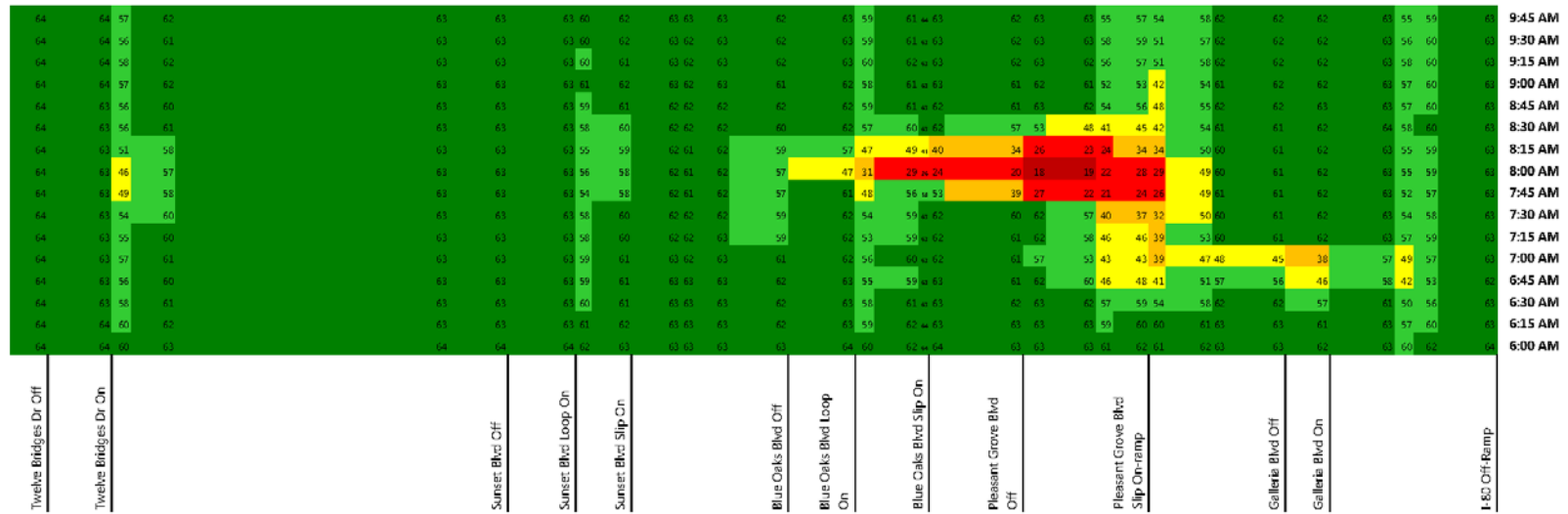

Figure 9 – Northbound SR 65 Existing Conditions Speed Contour Maps

AM PEAK PERIOD



PM PEAK PERIOD

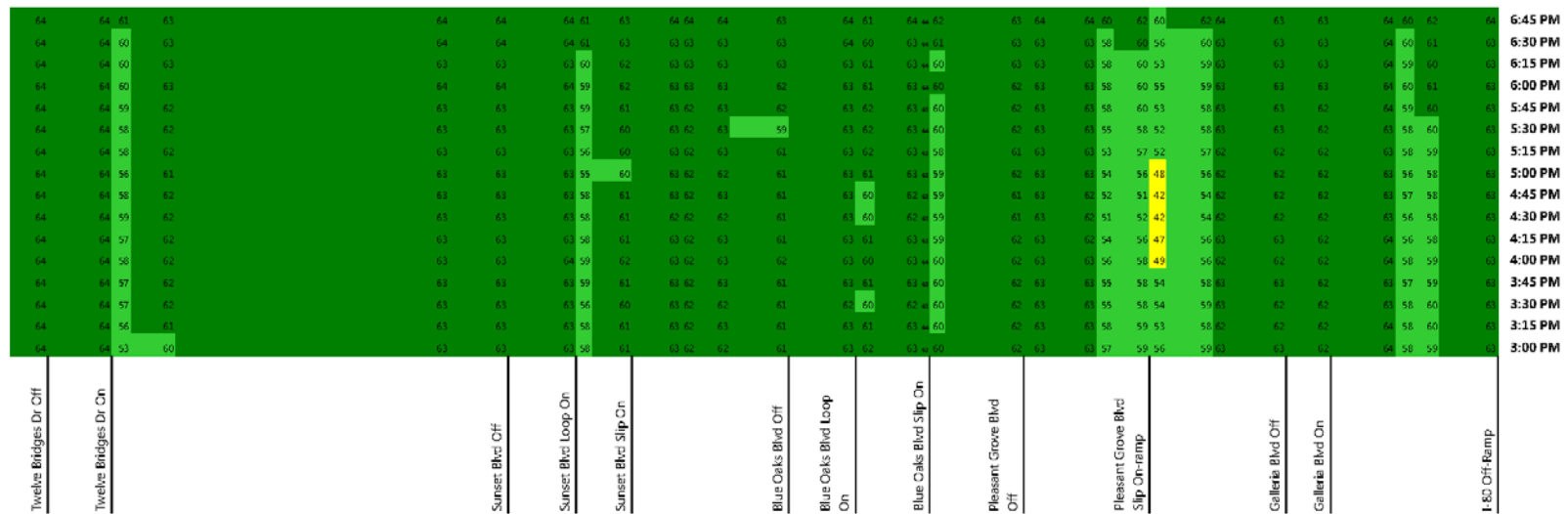
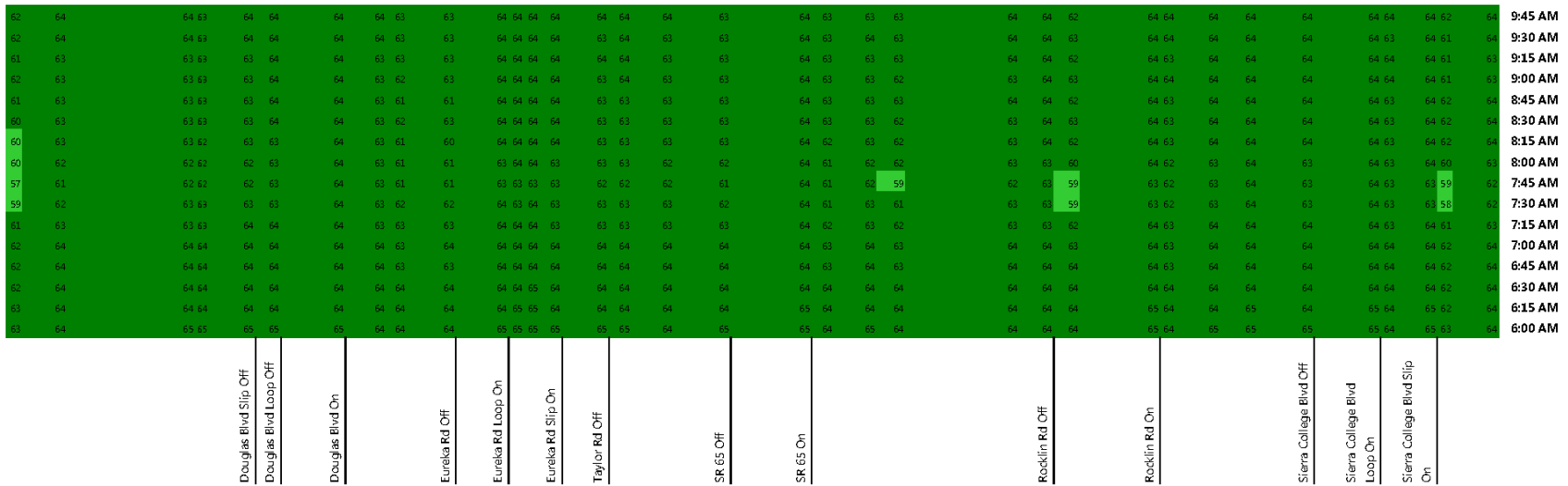

Figure 10 – Southbound SR 65 Existing Conditions Speed Contour Maps

AM PEAK PERIOD



PM PEAK PERIOD

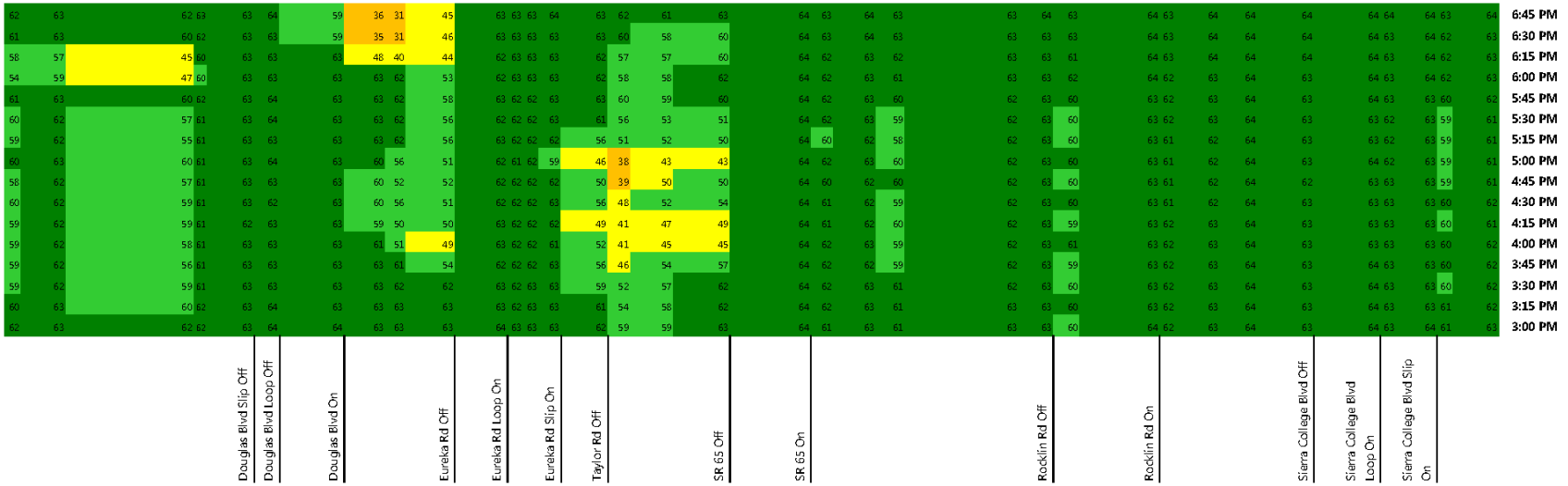
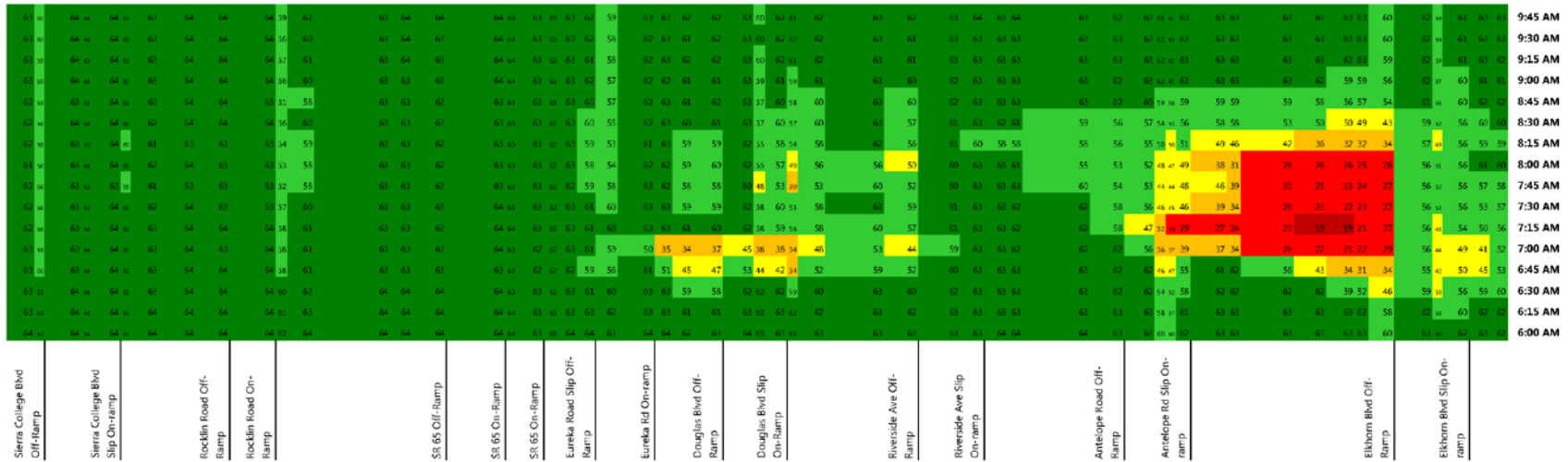

Figure 11 – Eastbound I-80 Existing Conditions Speed Contour Maps

AM PEAK PERIOD



PM PEAK PERIOD

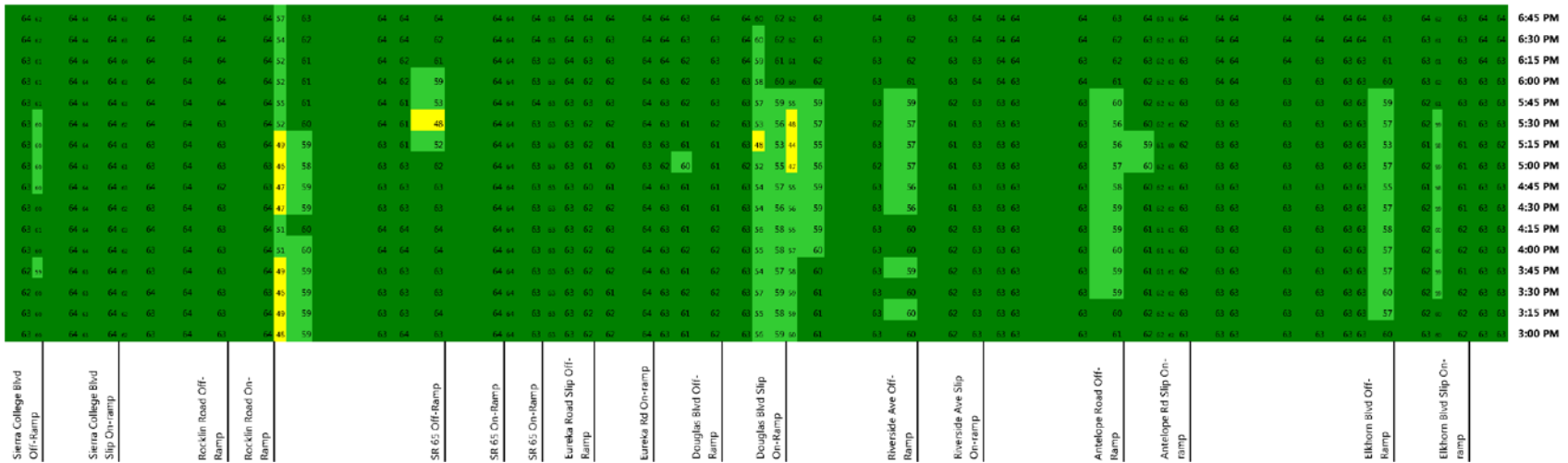

Figure 12 – Westbound I-80 Existing Conditions Speed Contour Maps

During the PM peak hour, the primary bottleneck is northbound SR 65 at the on-ramp from westbound I-80. This bottleneck results in LOS F conditions on eastbound I-80 at the SR 65 off-ramp. LOS E conditions exist from Taylor Road to Eureka Road, with the rightmost lanes mostly congested (queued from the SR 65 off-ramp) while the left lanes operate with higher speeds. The Eureka Road off-ramp has LOS F conditions due to queues spilling back from the ramp terminal intersection. (During summer 2012, queues regularly extended to the mainline occurred due to recreational trips generated by the water park on Taylor Road. After the Eureka Road widening project was completed in 2013, the peak hour off-ramp queues no longer extend to the mainline.) Westbound I-80 has LOS E conditions at the SR 65 off-ramp due to the same bottleneck. LOS D/E conditions occur further north on northbound SR 65 between Stanford Ranch Road and Pleasant Grove Boulevard. If the bottleneck at I-80 were relieved, this downstream will likely become congested.

3.2.2. Arterial Intersection Operations

In general, arterial intersections operate better than freeway locations during the peak hours. Table 8 shows the LOS and average delay at key study intersections under existing (2012) conditions. Based on the evaluation criteria for this study, all of the study intersections operate acceptably. See the Technical Appendix for all study intersection results.

The AM peak hour intersection LOS results indicate all intersections operate at LOS C or better, except for the Roseville Parkway/Sunrise Avenue and Blue Oaks Boulevard/Washington Boulevard intersections which operate at LOS D. The Roseville Parkway/Sunrise Avenue intersection operates with split phasing to accommodate the hospital driveway, which leads to less efficient operations. The Blue Oaks Boulevard intersection (which has a LOS C threshold) experiences high peak period peak direction traffic flows because it serves both inbound (employees) and outbound (residents) commuters for west Roseville.

During the PM peak hour, five intersections operate at LOS D or E:

- Galleria Boulevard/Roseville Parkway
- Roseville Parkway/Sunrise Avenue
- Eureka Road/Taylor Road/I-80 Eastbound Ramps
- Douglas Blvd/Sunrise Avenue
- Rocklin Road/Granite Drive

Like the Blue Oaks Boulevard intersection in the AM peak hour, the Roseville Parkway and Eureka Road corridors serve both inbound (residents and shoppers) and outbound (employees) commuters. Additionally, reduced speeds occur on eastbound Eureka Road approaching the I-80 interchange. A

project that widened eastbound Eureka Road at Taylor Road was completed in 2013 (after the existing conditions analysis). All other intersections operate at LOS C or better during the PM peak hour.

TABLE 8: SELECTED INTERSECTION OPERATIONS RESULTS – EXISTING (2012) CONDITIONS			
Intersection	Threshold	AM Peak Hour	PM Peak Hour
6. Blue Oaks Blvd / Washington Blvd / SR 65 SB Ramps	C	<u>D / 43</u>	C / 33
10. Stanford Ranch Rd / Five Star Blvd	C	B / 19	C / 32
11. Stanford Ranch Rd / SR 65 NB Ramps	D	A / 9	B / 15
12. Galleria Blvd / SR 65 SB Ramps	D	B / 13	B / 19
13. Galleria Blvd / Antelope Creek Dr	C	B / 10	C / 24
14. Galleria Blvd / Roseville Pkwy	E	C / 30	D / 36
15. Roseville Pkwy / Creekside Ridge Dr	C	A / 6	B / 17
16. Roseville Pkwy / Taylor Rd	D	C / 30	C / 28
17. Roseville Pkwy / Sunrise Ave	E	D / 37	D / 37
18. Atlantic St / Wills Rd	C	B / 10	B / 12
19. Atlantic St / I-80 WB Ramps	C	A / 7	B / 11
20. Eureka Rd / Taylor Rd / I-80 EB Ramps	E	C / 26	E / 61
21. Eureka Rd / Sunrise Ave	C	C / 24	C / 30
26. Douglas Blvd / Sunrise Ave	D	C / 26	D / 35
28. Pacific St / Sunset Blvd	C	B / 18	C / 29
29. Rocklin Rd / Granite Dr	C	B / 15	<u>D / 37</u>
30. Rocklin Rd / I-80 WB Ramps	C	C / 21	B / 17
31. Rocklin Rd / I-80 EB Ramps	C	B / 17	B / 20
32. Rocklin Rd / Aguilar Rd	C	A / 8	B / 13
Note: Bold and underline font indicate unacceptable operations. The LOS and average delay in seconds per vehicle are reported. Source: Fehr & Peers, 2015			

3.3. Traffic Safety

Traffic collision data was compiled from Caltrans’ Traffic Accident Surveillance and Analysis System (TASAS) for SR 65 from Stanford Ranch Road/Galleria Boulevard to Ferrari Ranch Road (post mile R6.2 to T12.9). The data shown are for the three-year period between October 1, 2009 and September 30, 2012. During this period, Sunset Boulevard was converted from an at-grade intersection to an interchange. Also, the Lincoln Bypass was not yet open to traffic. So, the accident data includes 4 accidents at intersections. Within the study area, 247 collisions occurred in the three-year period. Table 9 summarizes collisions on SR 65 by direction.

Direction	Total Accidents	Total Fatalities	Actual Collision Rate ¹			Average Collision Rate ¹		
			F	F&I	Total	F	F&I	Total
Northbound	116	0	0.000	0.14	0.36	0.007	0.23	0.66
Southbound	131	3	0.008	0.14	0.38	0.007	0.23	0.66
Total	247	3	0.004	0.14	0.37	0.007	0.23	0.66

Notes: 1. The accident rate is accidents per million vehicle-miles. “F” refers to the fatality rate, and “F&I” refers to the fatality and injury rate. Total number of accidents includes non-injury accidents, which are not listed separately.
 Source: Caltrans District 3 TASAS Table B, October 1, 2009 to September 30, 2012

The actual collision rate for fatalities was higher than statewide average for southbound SR 65. The three fatalities occurred in three separate collisions located on freeway sections, not at an intersection, and all had different locations. The remaining collision rates were lower than the statewide averages.

Table 10 categorizes the collisions by type. The most frequent collision type (50 percent) is a rear end collision, which is typical of congested conditions. The next most frequent collision types are side-swipe and hit object. The other collision types are collectively less than 15 percent of all collisions. The southbound direction has both a higher number of collisions and a higher number of rear end collisions.

Direction	Head On	Side Swipe	Rear End	Broad-side	Hit Object	Over-turn	Auto-Ped	Other
Northbound	0	20	53	2	31	8	1	1
Southbound	1	17	71	6	26	5	4	1
Total	1 (0.4%)	37 (15%)	124 (50%)	8 (3%)	57 (23%)	13 (5%)	5 (2%)	2 (1%)

Source: Caltrans District 3 TASAS - Table B, October 1, 2009 to September 31, 2012

Chapter 4. Travel Demand Forecasts

The travel demand forecasts were developed using a validated sub-area model derived from the SACMET regional travel demand forecasting (TDF) model developed by SACOG⁵. The approach to developing travel demand forecasts started with the recognition that regional travel demand models do not contain sufficient detail or sensitivity for local applications like developing directional freeway mainline and ramp volume forecasts. Instead, the regional model provides a starting point for creating a more detailed sub-area model along the freeway corridor. Having a valid sub-area model is a critical step in ensuring a high level of confidence in the traffic volume forecasts that will be used to evaluate the effects of improving the SR 65 corridor.

4.1. Sub-Area Model Development and Model Validation

The forecast modeling for the SR 65 Capacity and Operational Improvements project used the same sub-area model developed for the I-80/SR 65 Interchange Improvements project. Please refer to Chapter 4 of the *I-80/SR 65 Interchange Improvements Transportation Analysis Report* (August 2014).

4.2. Future Year Forecasts

Traffic forecasts for design and construction year analysis were developed for the following project alternatives.

1. Carpool Lane
2. General Purpose Lane
3. No Build

4.2.1. Design Year Forecasts

From a macro perspective, the proposed project alternatives – freeway corridor widening – are not expected to change regional travel demand. A sensitivity test of the SACMET model showed almost no change in travel demand with a change in capacity at the I-80/SR 65 interchange. Instead, the most significant effects on future traffic volumes will occur in terms of trip routing within the meso-scale study area due to travel time differences caused by the alternatives. Therefore, the same set of trip tables is used for the project alternatives, which means that volumes at the sub-area boundaries are the same across all alternatives.

⁵ The SACMET model used for this project was released in May 2011 and was developed to be consistent with the Sacramento Area Council of Governments Metropolitan Transportation Plan/Sustainable Communities Strategy 2035.

The volume forecast process began with isolating the incremental peak period volume growth (2008 to 2035) between traffic analysis zones (TAZs) in the sub-area using the modified SACMET model (macro level). This incremental growth was then added to the base year Visum trip table (meso level) that was derived from the Airsage cell phone data. The incremental SACMET growth was inspected to verify that the changes in origin-destination trips were commensurate with the location of socioeconomic growth. Individual origin-destination pair volumes were not allowed to decrease between base and cumulative years.

In the next step, the four-hour peak period trip tables were divided into hourly trip tables by mode: SOV, HOV, and truck. The conversion from peak period to hourly trip tables used the existing ratio of hourly traffic volume to peak period volume. The mode share for HOVs was based on the relative peak period mode share in the 2035 SACMET model. For the entire meso study area, the overall forecast HOV shares are 18 and 19 percent during the AM and PM peak periods, respectively. The truck share is assumed to increase from 2.7 and 1.4 percent under existing conditions to 3.0 and 2.0 percent under the design year for the AM and PM peak periods, respectively.

Some adjustments were made to the HOV shares for select locations based on previous comments from Caltrans about HOV forecasts being lower than observed conditions on I-80. Table 11 shows the AM and PM peak hour HOV percentages for the I-80 western gateway from the 2035 SACMET model, the 2012 traffic counts, and the proposed 2040 forecast values. The 2008 and 2035 SACMET model forecasts show similar values of 11 to 13 percent at this gateway. These values are lower than the traffic counts that were collected in 2012. The proposed 2040 HOV percentages use the 2012 traffic count percentages for the off-peak directions. In the peak direction, a five percentage point increase was assumed to compensate for the difference between model estimates and counts. Additionally, traffic congestion is expected to be more severe in the design year, which would encourage the formation of carpools.

Direction	2035 SACMET		2012 Counts		2040 Forecast	
	AM	PM	AM	PM	AM	PM
Eastbound	11%	13%	15%	17%	15%	22%
Westbound ¹	13%	13%	14%	18%	19%	18%

Note: 1. The count location was at the Riverside Ave/Auburn Blvd overcrossing, but the westbound study area gateway is between Elkhorn Blvd and Madison Ave.
 Source: Fehr & Peers, 2015

The five percentage point increase was also validated based on a June 2012 sampling of traffic volumes at the I-80/Douglas Boulevard, I-80/Eureka Road, and SR 65/Galleria Boulevard on-ramps, which found HOV percentages ranging from 9 to 25 percent for the AM peak hour and 14 to 36 percent for the PM peak hour. The AM and PM peak hour averages of 16 and 24 percent from these samples are generally similar

to the 2035 SACMET forecasts of 18 and 19 percent, respectively. However, peak direction HOV percentages were some of the largest values observed. The adjustments noted in Table 13 result in HOV volume forecasts that are at or near the carpool lane operating capacity under design year conditions, so they were considered reasonable for purposes of this study.

The future year Visum trip tables were then assigned to each project alternative network. These networks included all the planned transportation improvements shown in Figures 2 and 3 plus unique features of each alternative⁶. The preliminary forecasts from this step were reviewed and adjusted for anomalies such as unexpected decreases in traffic volumes when compared to existing conditions. The expected decreases that occurred are noted below.

- Riverside Avenue slip on-ramp to westbound I-80 – This ramp shows a decrease over existing volumes. This decrease is allowed since the cumulative roadway network includes several projects that increase parallel capacity between west Roseville and Sacramento County (widening Baseline Road/Riego Road between SR 99 and Foothills Boulevard, widening Watt Avenue, etc.). These capacity enhancements redistribute some existing long-distance trips from Placer County to Sacramento County to alternative routes.
- Sunset Boulevard loop on-ramp to southbound SR 65 – The construction of the SR 65/Whitney Ranch Parkway/Placer Parkway interchange provides an alternate route so that the demand at SR 65/Sunset Boulevard is lower.
- Taylor Road off-ramp from eastbound I-80 – With the widening of the eastbound to northbound freeway connector, traffic destined to Rocklin can use SR 65 to Stanford Ranch Road rather than the more indirect route of Taylor Road and Pacific Street to Sunset Boulevard.

Although the decrease in traffic volume was allowed, the actual future volume may be subject to the induced travel effect (discussed below in section 4.2.6) that could result in a volume that is higher than predicted. The final trip tables and the associated travel paths from the Visum assignment were transferred to Vissim for final assignment and analysis.

A final volume adjustment was made in the northern end of the study area to account for recent land use planning decisions in the City of Lincoln. With the opening of the Lincoln Bypass, development is now planned to occur in the western portion of the city rather than the central and eastern areas. The forecast model prepared for the South Placer Regional Transportation Authority (SPRTA) fee study used the new land use values. By comparing the initial model volumes between the I-80/SR 65 Interchange and SPRTA fee study versions of the SACMET model, an adjustment process was developed to shift a portion of the volume from Lincoln Boulevard north of Sterling Parkway to SR 65 north of Ferrari Ranch Road. For further details, please see the technical memorandum on this topic in the Appendix.

⁶ As noted in Chapter 2, the project alternative lane configurations for the forecast model differ from the final project alternatives since the alternatives were refined after the initial analysis results were prepared.

Figures 13 through 15 display the SR 65 freeway lane configurations associated with each alternative, along with the AM and PM peak hour traffic volume forecasts. These volumes represent traffic demand that may not be fully accommodated during the peak hour, which is determined as part of the Vissim analysis. The traffic forecasts for the I-80 corridor and the study intersections are provided in the Appendix.

Figures 16 and 17 show design year volume comparison plots between project alternatives. The orange and red colors indicate a volume decrease for the AM and PM peak hours, respectively. The blue and green colors indicate a volume increase for the AM and PM peak hours, respectively. For these bandwidth plots, the freeway carpool lane links have been turned off so that the changes to the regular mainline lanes can be shown.

Figure 16 shows a comparison of Alternative 2 (General Purpose Lane) and 3 (No Build). With the additional capacity on SR 65, volumes are higher from I-80 to Lincoln Boulevard. Volume increases also occur on arterials that access SR 65. Routes parallel to the freeway segment show decreases: Sunset Boulevard, Wildcat Boulevard, Industrial Avenue, Fairway Drive, and Roseville Parkway. The differences between Alternatives 1 (Carpool Lane) and 3 (No Build) are similar.

Figure 17 shows the volume differences between Alternatives 1 (Carpool Lane) and 2 (General Purpose Lane). Although both alternatives would widen the SR 65 corridor, the first alternative restricts one of the added lanes between Stanford Ranch Road/Galleria Boulevard and Blue Oaks Boulevard to HOVs. Due to this restriction, the northbound peak hour volume is higher on SR 65 for Alternative 2 (shown as blue and green colors in the figure). In the southbound direction, Alternative 1 has higher volumes between Blue Oaks Boulevard and Pleasant Grove Boulevard because this alternative has an additional lane (the carpool lane) compared to Alternative 2. Alternative 2 has higher volumes on SR 65 south of Pleasant Grove Boulevard. Importantly, the Alternative 1 and 2 peak hour volumes are more similar than the Alternative 2 and 3 volumes. The largest difference shown in Figure 17 is about 300 vehicles per hour (vph), but the largest difference in Figure 16 is about 1,600 vph, or about a 40 percent increase.

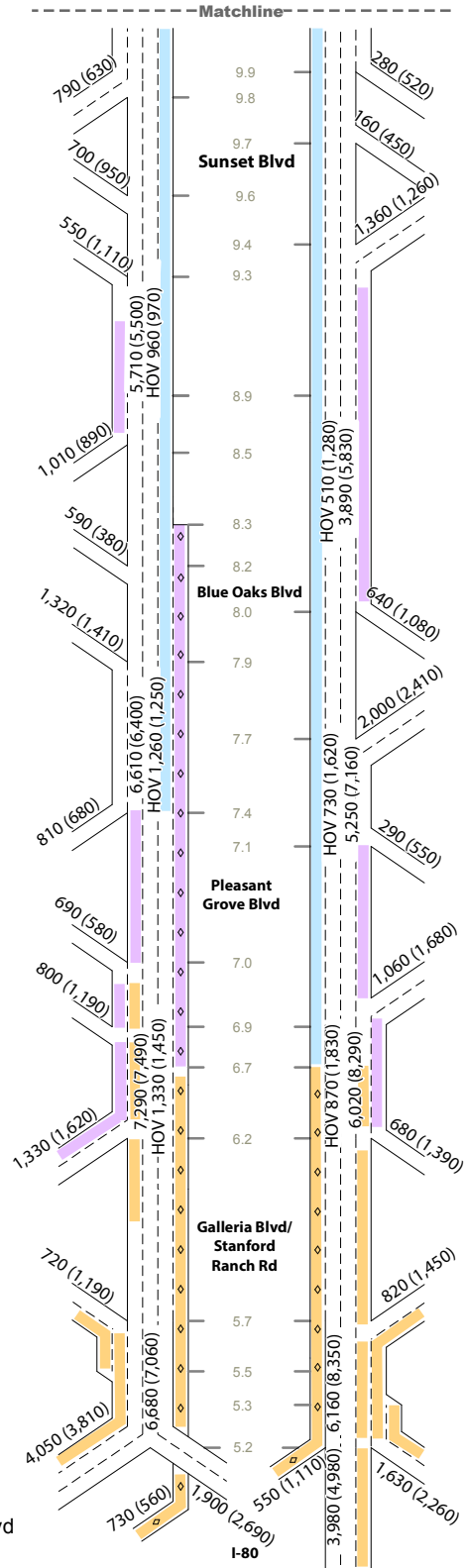
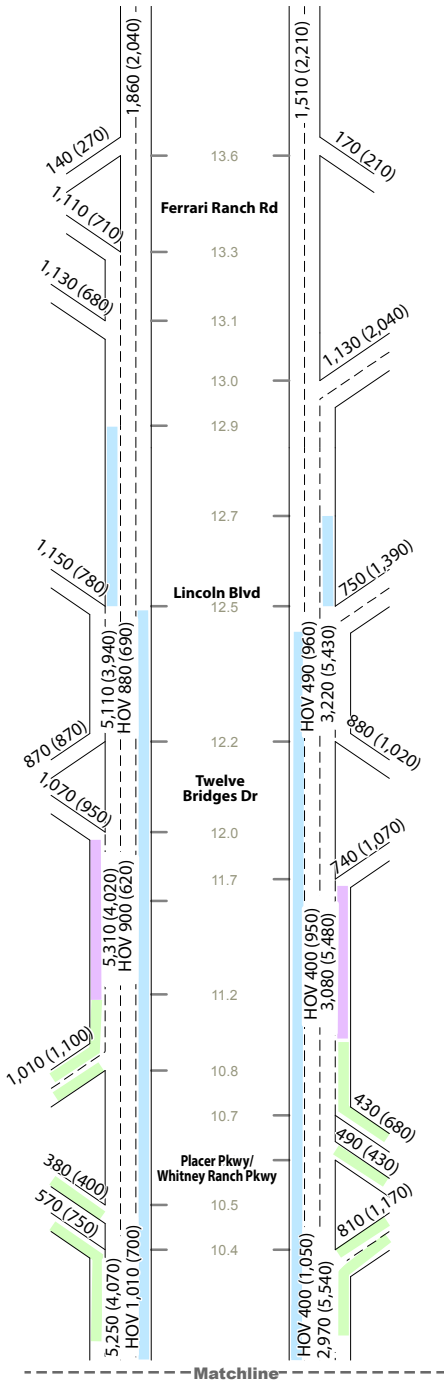

LEGEND

- AM (PM) Peak Hour Total Volume
- HOV AM (PM) Peak Hour HOV Volume
- 10.1 Postmile
- Carpool Lane (Alternative 1)
- Separate Planned Projects**
 - I-80/SR 65 Interchange
 - SR 65 Widening from Blue Oaks Blvd to Ferrari Ranch Rd
 - Placer Parkway/Whitney Ranch Parkway Interchange

Figure 13

Design Year Peak Hour Traffic Volumes and Lane Configurations - Carpool Lane (Alternative 1)



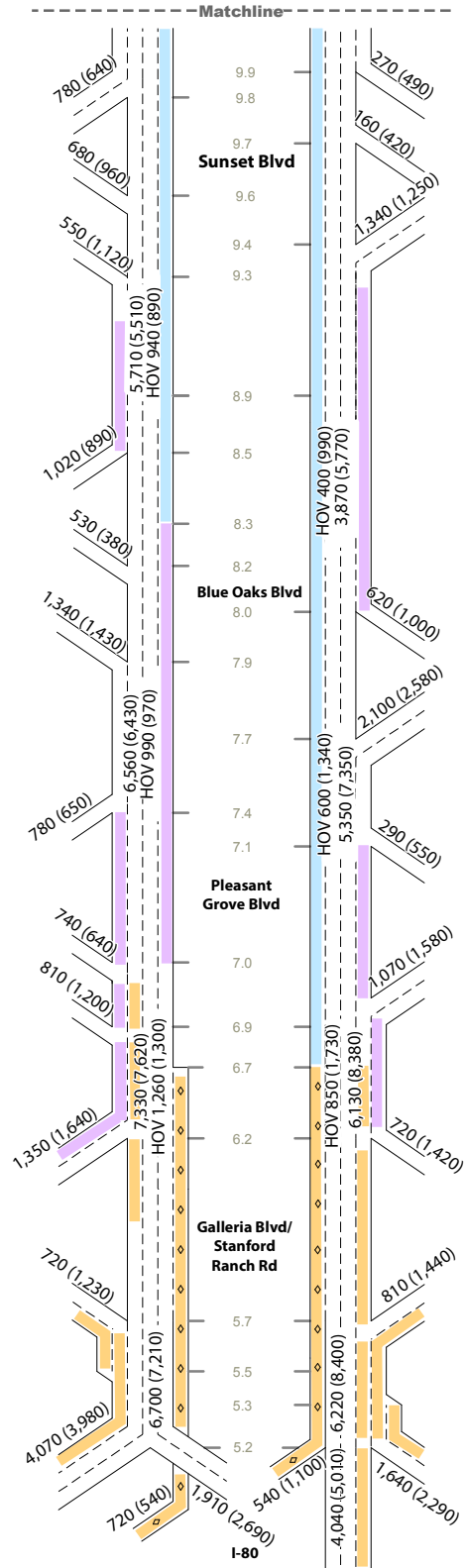
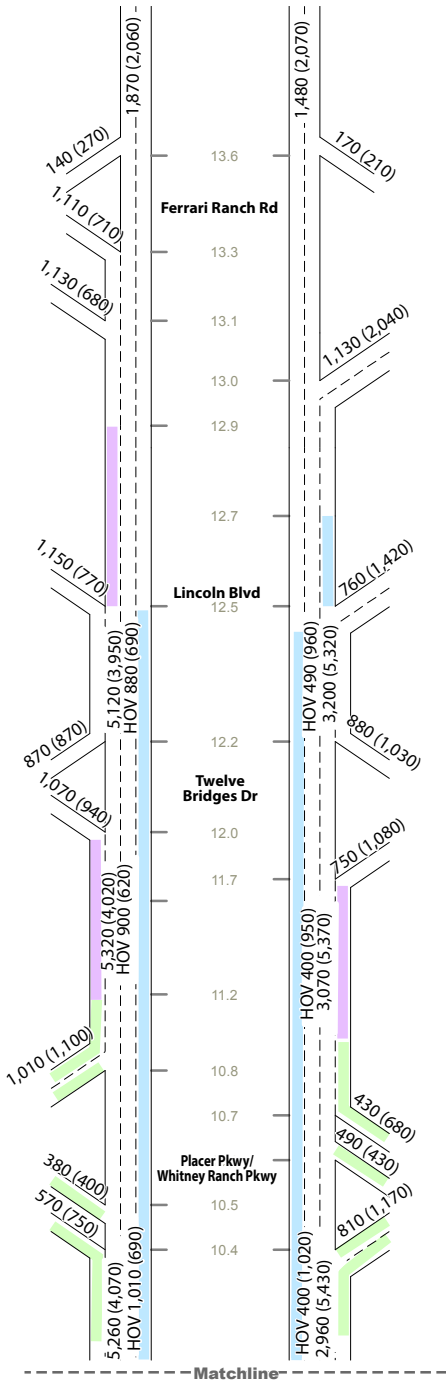

LEGEND

- AM (PM) Peak Hour Total Volume
- HOV AM (PM) Peak Hour HOV Volume
- 10.1 Postmile
- General Purpose Lane (Alternative 2)

- Separate Planned Projects**
- I-80/SR 65 Interchange
 - SR 65 Widening Blue Oaks Blvd to Ferrari Ranch Rd
 - Placer Parkway/Whitney Ranch Parkway Interchange

Figure 14

Design Year Peak Hour Traffic Volumes and Lane Configurations - General Purpose Lane (Alternative 2)



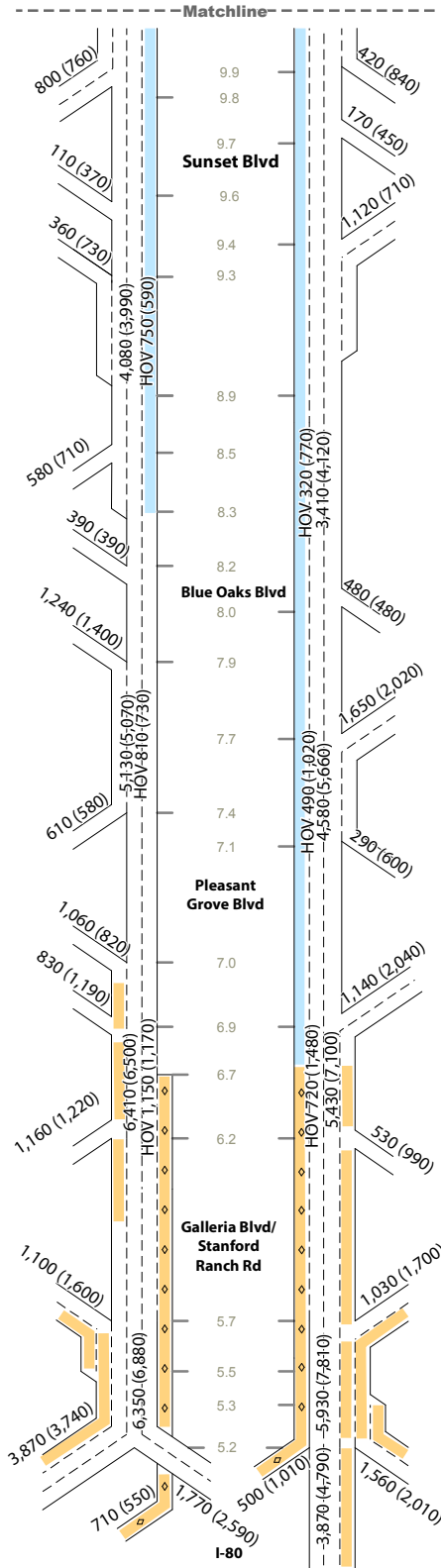
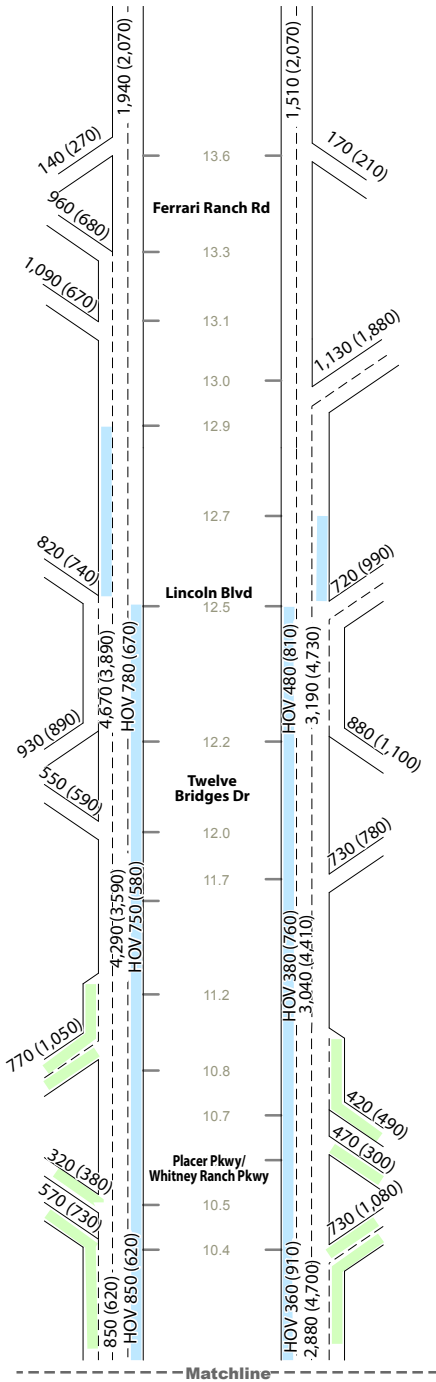

LEGEND

AM (PM) Peak Hour Total Volume
 HOV AM (PM) Peak Hour HOV Volume
 10.1 Postmile

Separate Planned Projects

- I-80/SR 65 Interchange
- SR 65 Widening from Blue Oaks Blvd to Ferrari Ranch Rd
- Placer Parkway/Whitney Ranch Parkway Interchange

Figure 15

Design Year Peak Hour Traffic Volumes and Lane Configurations - No Build (Alternative 3)



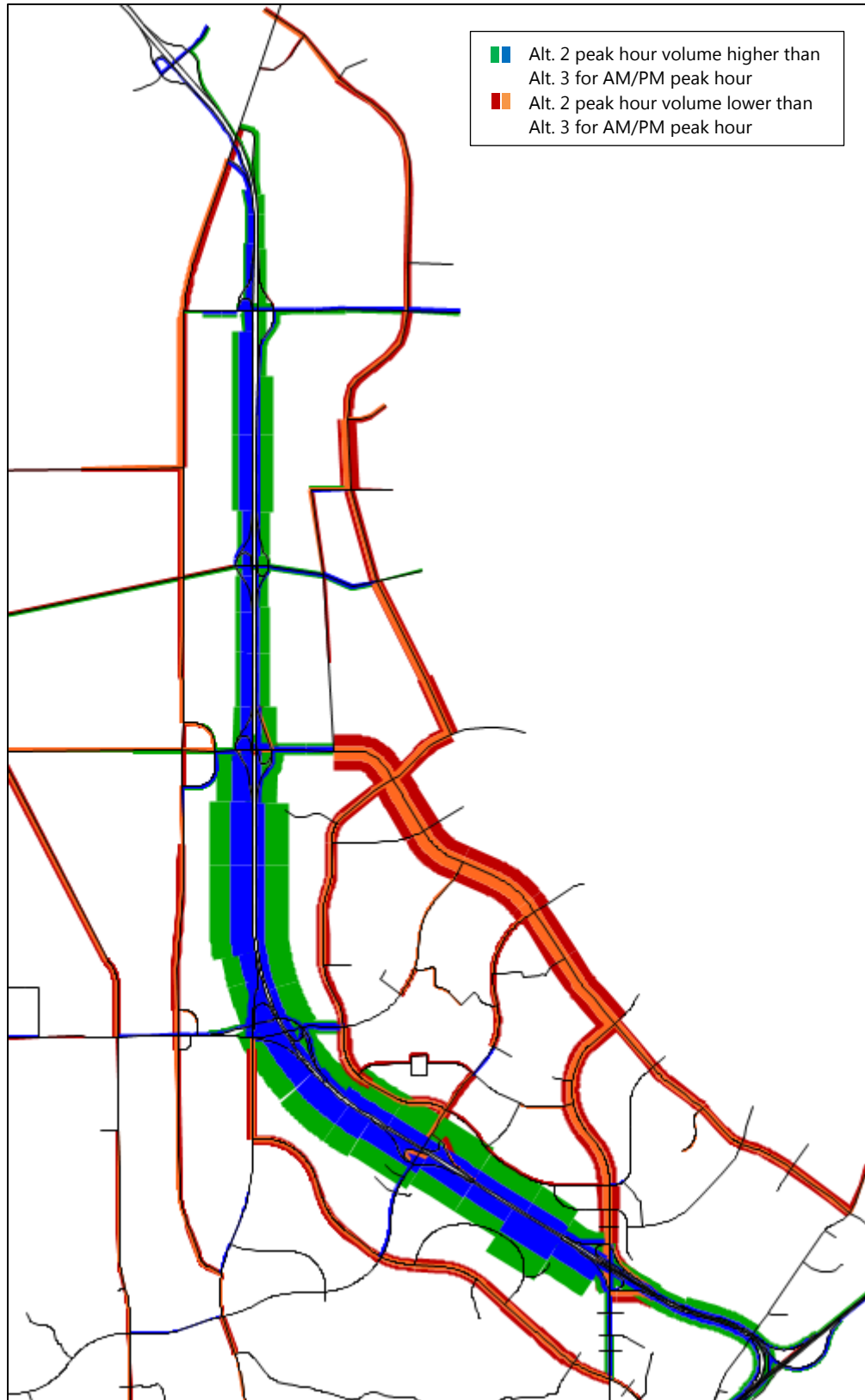

Figure 16 – Volume Comparison of Alternatives 2 and 3

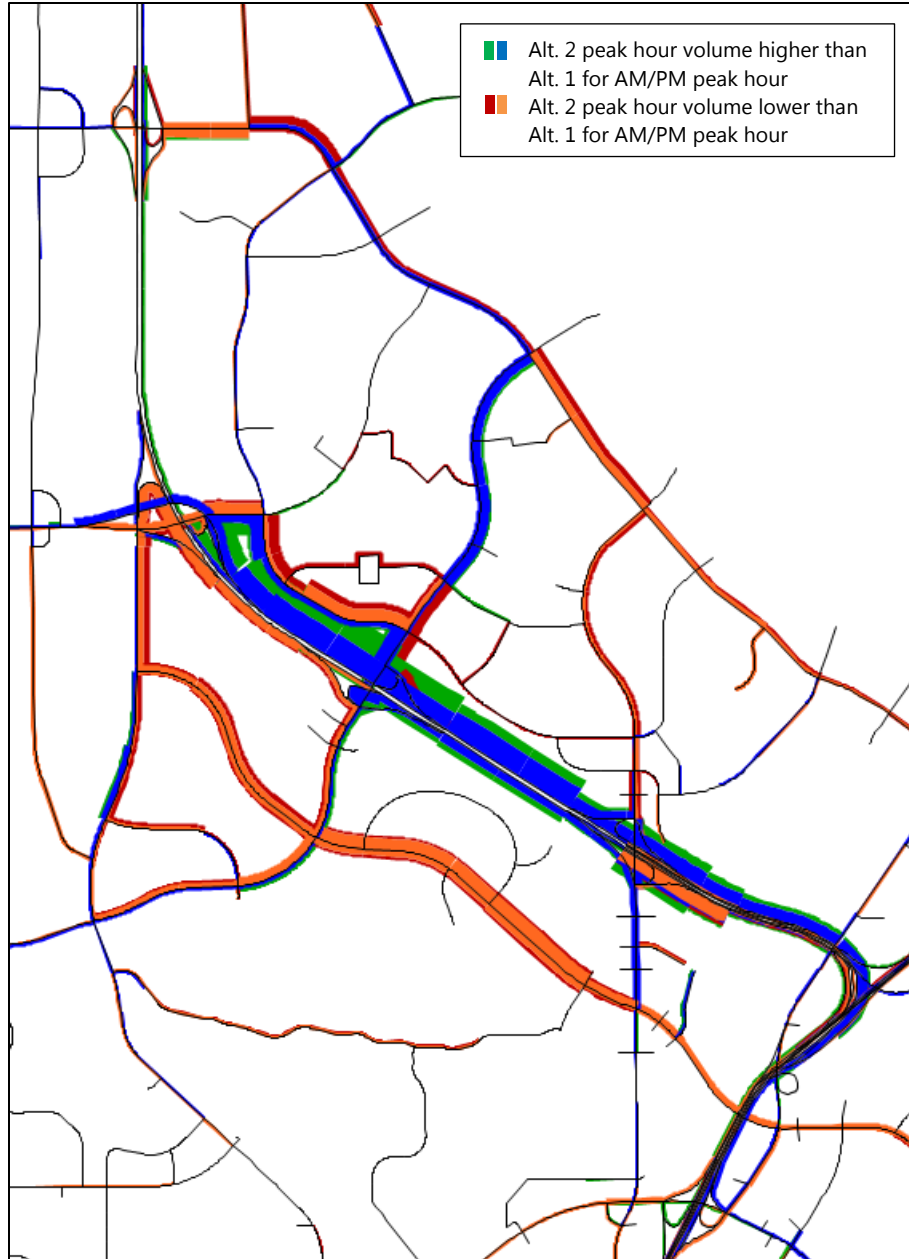

Figure 17 – Volume Comparison of Alternatives 1 and 2

4.2.2. HOV Volume Forecasts

The Visum model includes carpool lanes as separate roadway links to account for the additional HOV-only capacity. The resulting carpool lane projections for the project alternatives are listed in Table 12. The volumes for the section between I-80 and Stanford Ranch Road/Galleria Boulevard are for the median carpool ramps. The future configuration of the I-80/SR 65 interchange will restrict movement into and out of the carpool lane south of Stanford Ranch Road/Galleria Boulevard.

TABLE 12: CARPOOL LANE PEAK HOUR VOLUME FOR DESIGN YEAR CONDITIONS

Direction	Location	Alternative 1		Alternative 2		Alternative 3	
		AM	PM	AM	PM	AM	PM
Northbound	I-80 to Stanford Ranch Rd	545	1,105	535	1,100	495	1,000
	Stanford Ranch Rd to Pleasant Grove Blvd	750	1,530	730	1,500	500	1,000
Southbound	Blue Oaks Blvd to Pleasant Grove Blvd	1,150	1,150	-	-	-	-
	Pleasant Grove Blvd to Galleria Blvd	1,165	1,075	1,100	1,030	700	540
	Galleria Blvd to I-80	730	555	715	535	700	540

Source: Fehr & Peers, 2015

With the addition of the mainline carpool lane in Alternative 1 (Carpool Lane), the carpool direct connector ramp volume would increase compared to Alternatives 2 (General Purpose Lane) and 3 (No Build). The carpool lane peak hour volume is projected to be as high as 1,530 vph northbound and 1,165 vph southbound. The additional mainline capacity for Alternative 2 results in a carpool lane volume at the I-80 interchange that is higher (between 5 and 100 vph) than in Alternative 3.

4.2.3. Meso-Scale Network Performance for Design Year

In addition to generating traffic volume forecasts for input to the Vissim microsimulation traffic operations model, the Visum model was used to produce the same meso-scale network performance measures reported for existing conditions. Figures 18 through 22 compare network performance across the project alternatives for design year conditions during the AM, the PM, and both the AM and PM peak periods. The reported performance measures are VMT, VHT, VHD, freeway VHD, and project-area freeway VHD, where the project area is SR 65 between Stanford Ranch Road/Galleria Boulevard and Ferrari Ranch Road.

The build alternatives increase VMT although the change is only about 0.5 percent (VMT is reported by 5-mph speed bin in the appendix). The results generally show that the build alternatives improve network efficiency by lowering VHT and VHD compared to the No Build Alternative. Alternative 2 (General Purpose Lane) has more VMT, but lower VHT and VHD, than Alternative 1 (Carpool Lane). Figure 22 shows that the build alternatives would reduce freeway delay by at least 85 percent in the project area.

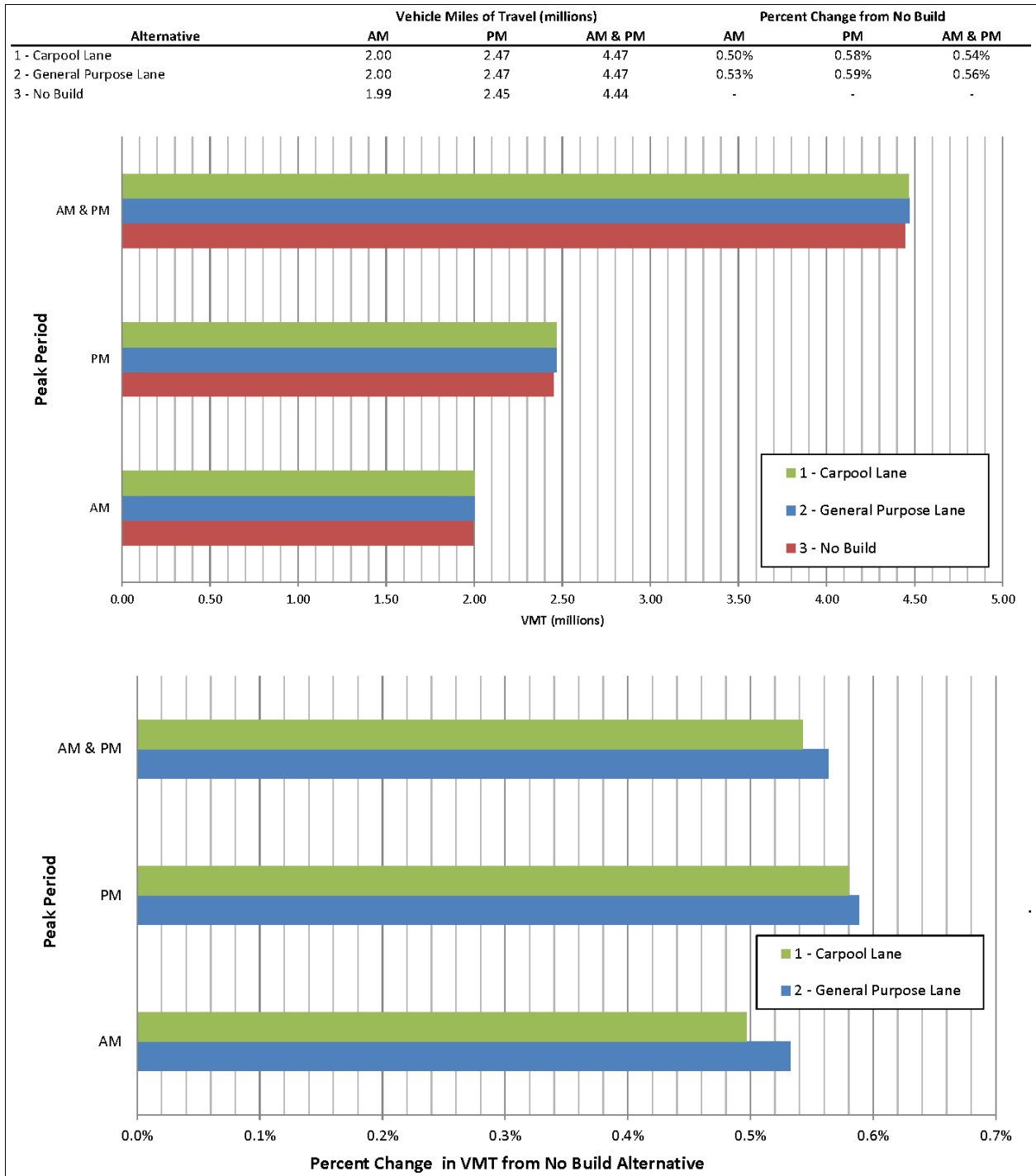

Figure 18 – Design Year Meso-Scale VMT Comparison

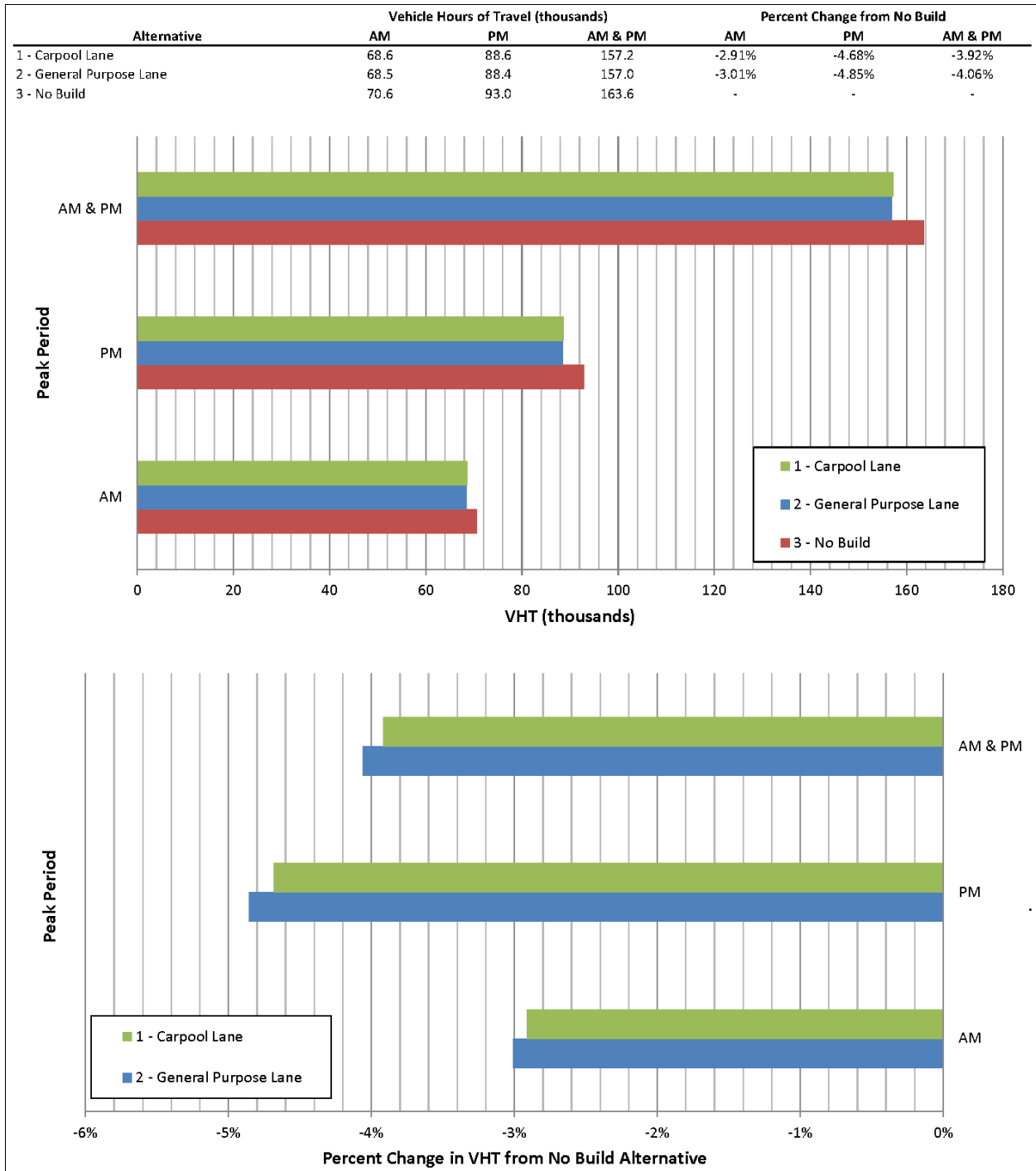

Figure 19 – Design Year Meso-Scale VHT Comparison

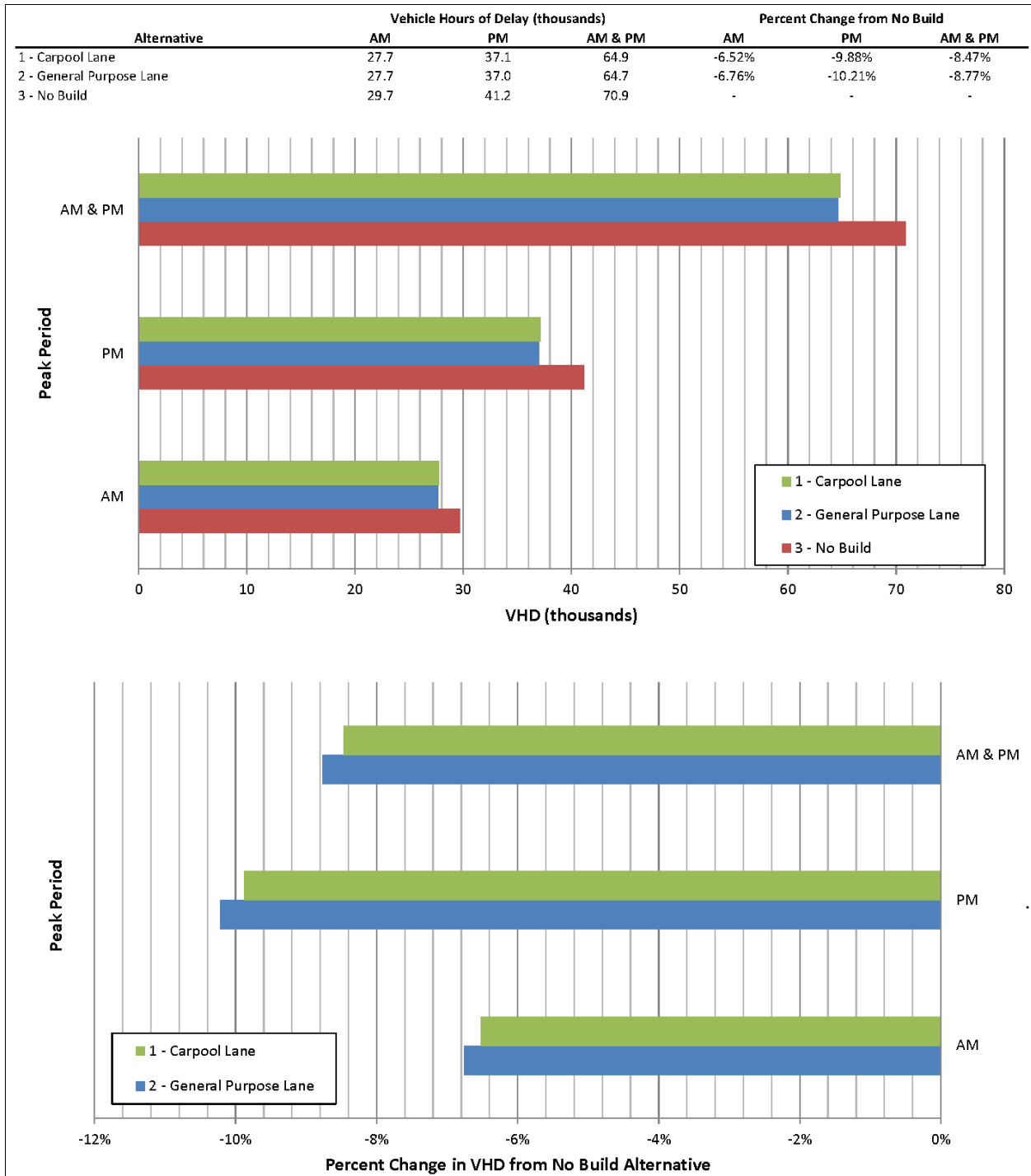

Figure 20 – Design Year Meso-Scale VHD Comparison

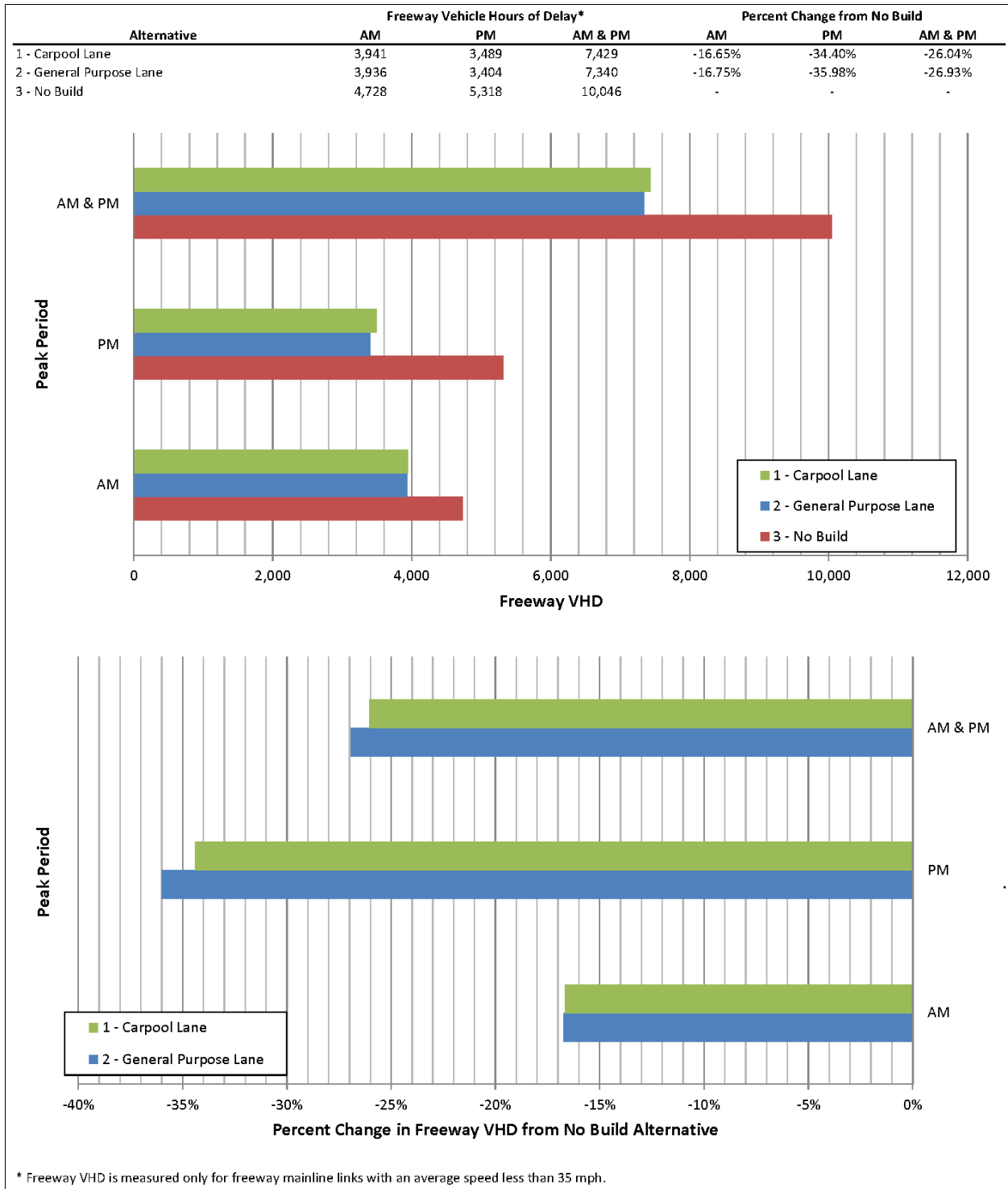

Figure 21 – Design Year Meso-Scale Freeway VHD Comparison

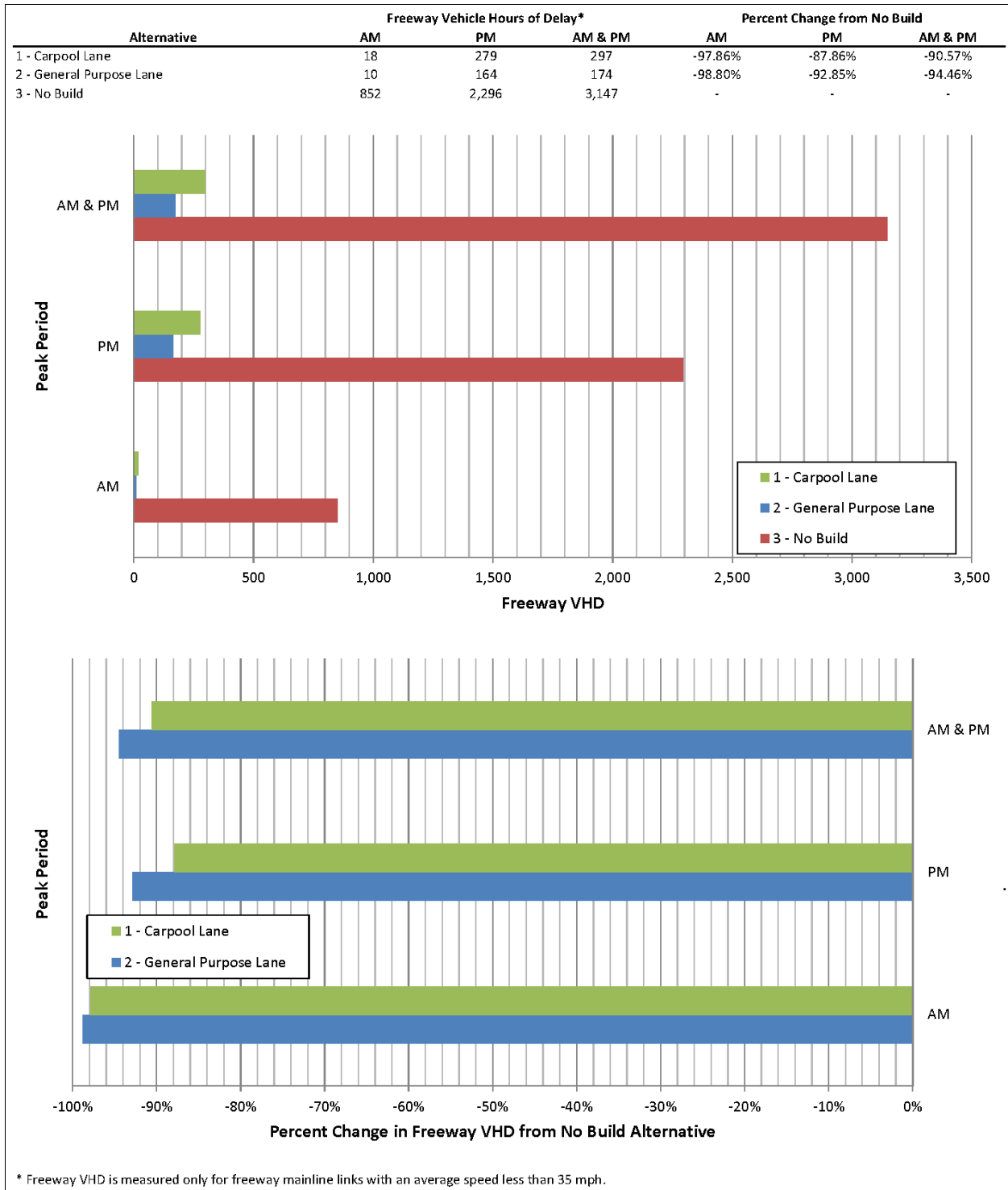

Figure 22 – Design Year Meso-Scale Project-Area Freeway VHD Comparison

4.2.4. Construction Year Forecasts

The construction year (2020) forecasts shown in Figures 23 through 25 were developed by interpolating between the hourly matrices for the baseline (2012) traffic volume estimates and the design year (2040) forecasts. Using Visum, the resulting matrices were assigned to the roadway network that corresponds to the planned projects expected to be completed by 2020 (as shown in Figure 2)⁷. Due to these changes, construction year demand volumes at any particular location may not be the exact linearly interpolated value between the existing and design year volumes.

This process presumes a linear growth relationship and captures some of the influence of project alternatives on trip assignment. One of the potential limitations of this approach is that recent growth has not kept pace with the projected linear growth rate. The sluggish economic recovery from the 2008/09 recession may result in actual construction year volumes that are lower than the projections, but this outcome is acceptable for the purpose of designing and evaluating project alternatives.

4.2.5. Meso-Scale Network Performance for Construction Year

In addition to generating traffic volume forecasts for input to the Vissim microsimulation traffic operations model, the Visum model was used to produce the same meso-scale network performance measures reported for existing conditions. Figures 26 through 31 compare network performance across the project alternatives for construction year conditions during the AM, the PM, and both the AM and PM peak periods. The reported performance measures are VMT, VHT, VHD, freeway VHD, and project-area freeway VHD, where the project area is SR 65 between Stanford Ranch Road/Galleria Boulevard and Ferrari Ranch Road (VMT by 5-mph speed bin is reported in the appendix).

The results show that the build alternatives increase VMT and reduce VHT and VHD compared to the no build alternative. Alternative 2 (General Purpose Lane) has lower network-wide VHT and VHD, but Alternative 1 (Carpool Lane) has lower VMT and freeway VHD, for both the study and project areas.

⁷ As noted previously, the build alternatives originally included mainline widening north of Blue Oaks Boulevard. The construction year forecast models include this widening, which results in volumes that are higher than would be expected. The construction year volumes for the No Build Alternative are not affected.

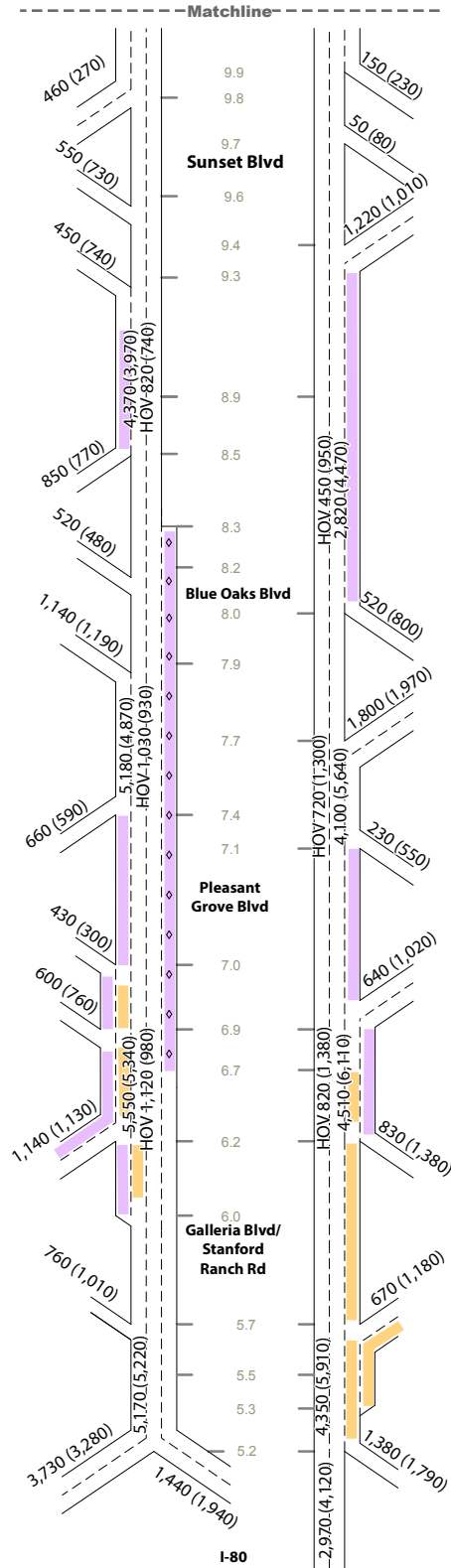
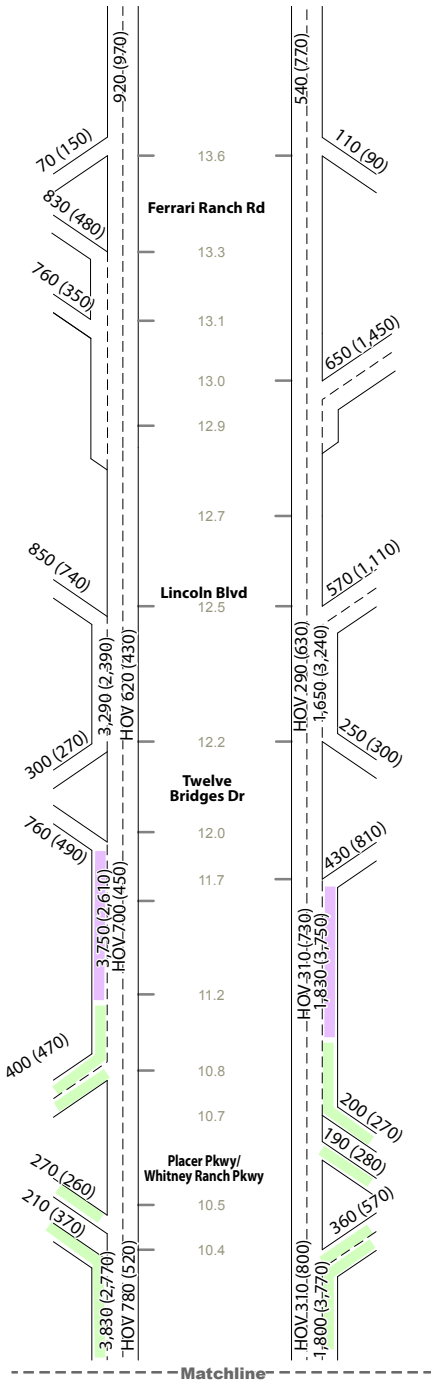

LEGEND

AM (PM) Peak Hour Total Volume
 HOV AM (PM) Peak Hour HOV Volume
 10.1 Postmile

- Separate Planned Projects**
- I-80/SR 65 Interchange Phase 1
 - Placer Parkway/Whitney Ranch Parkway Interchange
 - Carpool Lane (Alternative 1)

Figure 23
 Construction Year Peak Hour Traffic Volumes
 and Lane Configurations -
 Carpool Lane (Alternative 1)



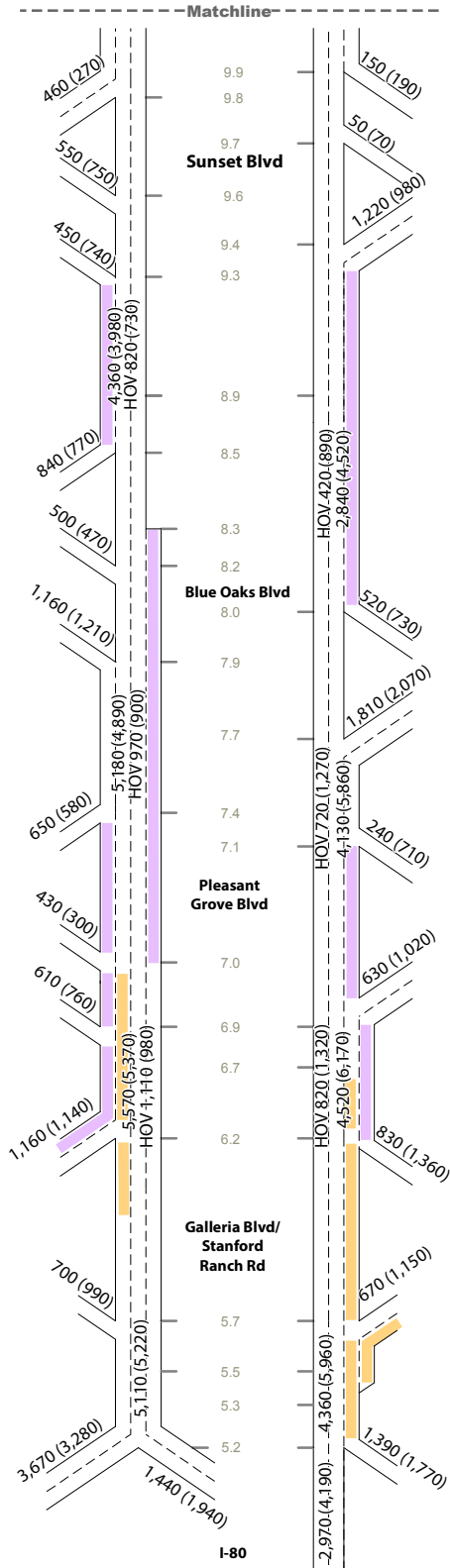
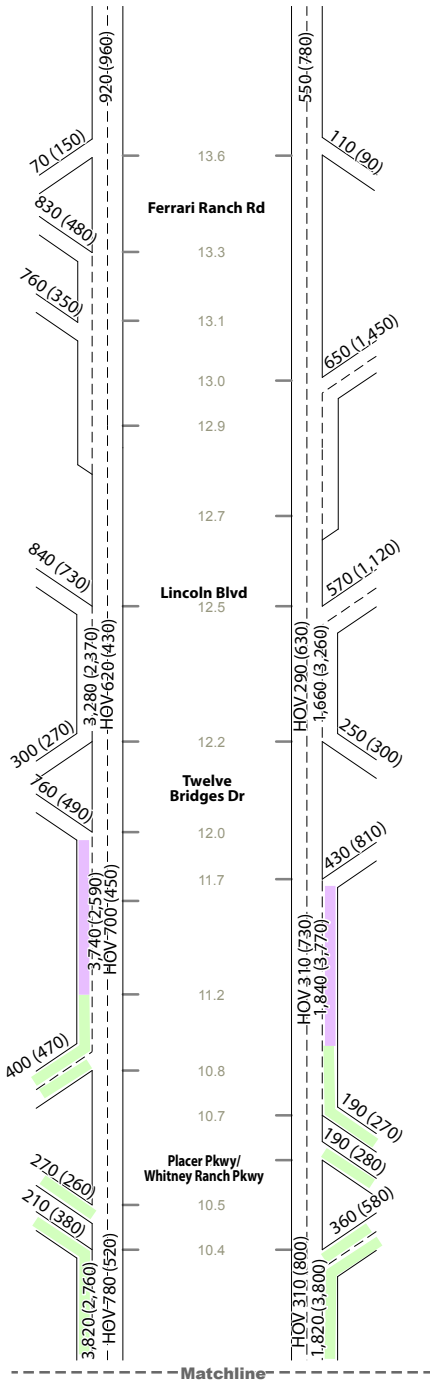

LEGEND

AM (PM) Peak Hour Total Volume
 HOV AM (PM) Peak Hour HOV Volume
 10.1 Postmile

Separate Planned Projects
 I-80/SR 65 Interchange Phase 1
 Placer Parkway/Whitney Ranch Parkway Interchange
 General Purpose Lane (Alternative 2)

Figure 24

Construction Year Peak Hour Traffic Volumes and Lane Configurations - General Purpose Lane (Alternative 2)



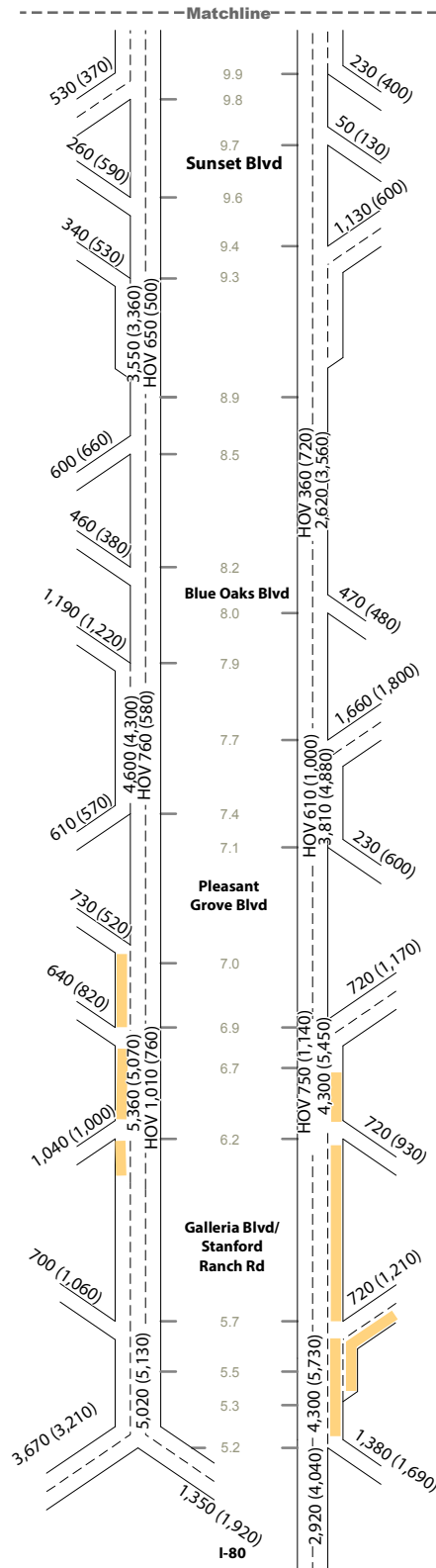
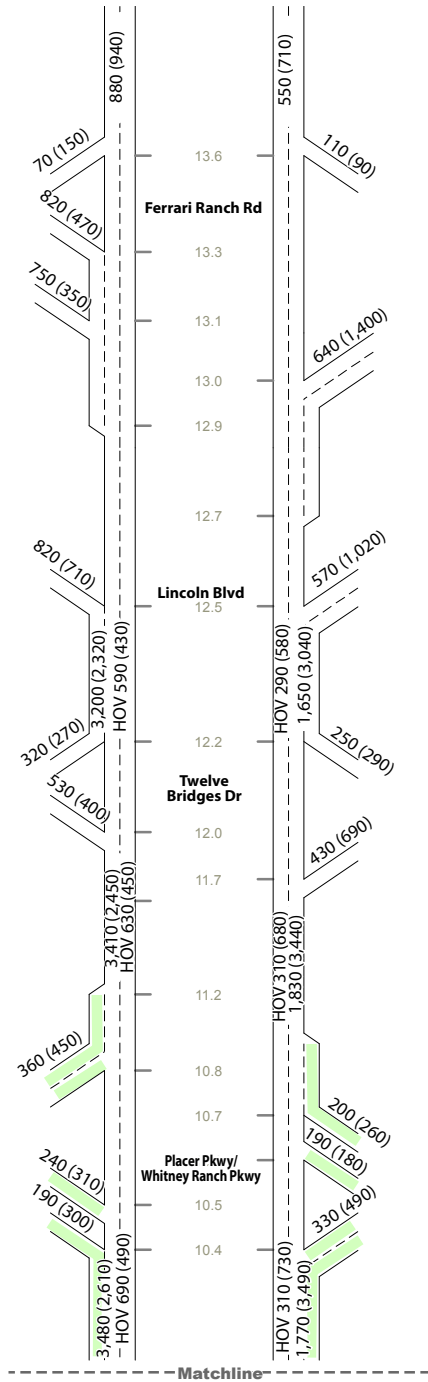

LEGEND

AM (PM) Peak Hour Total Volume
 HOV AM (PM) Peak Hour HOV Volume
 10.1 Postmile

Separate Planned Projects
 I-80/SR 65 Interchange Phase 1
 Placer Parkway/Whitney Ranch Parkway Interchange

Figure 25

Construction Year Peak Hour Traffic Volumes and Lane Configurations - No Build (Alternative 3)



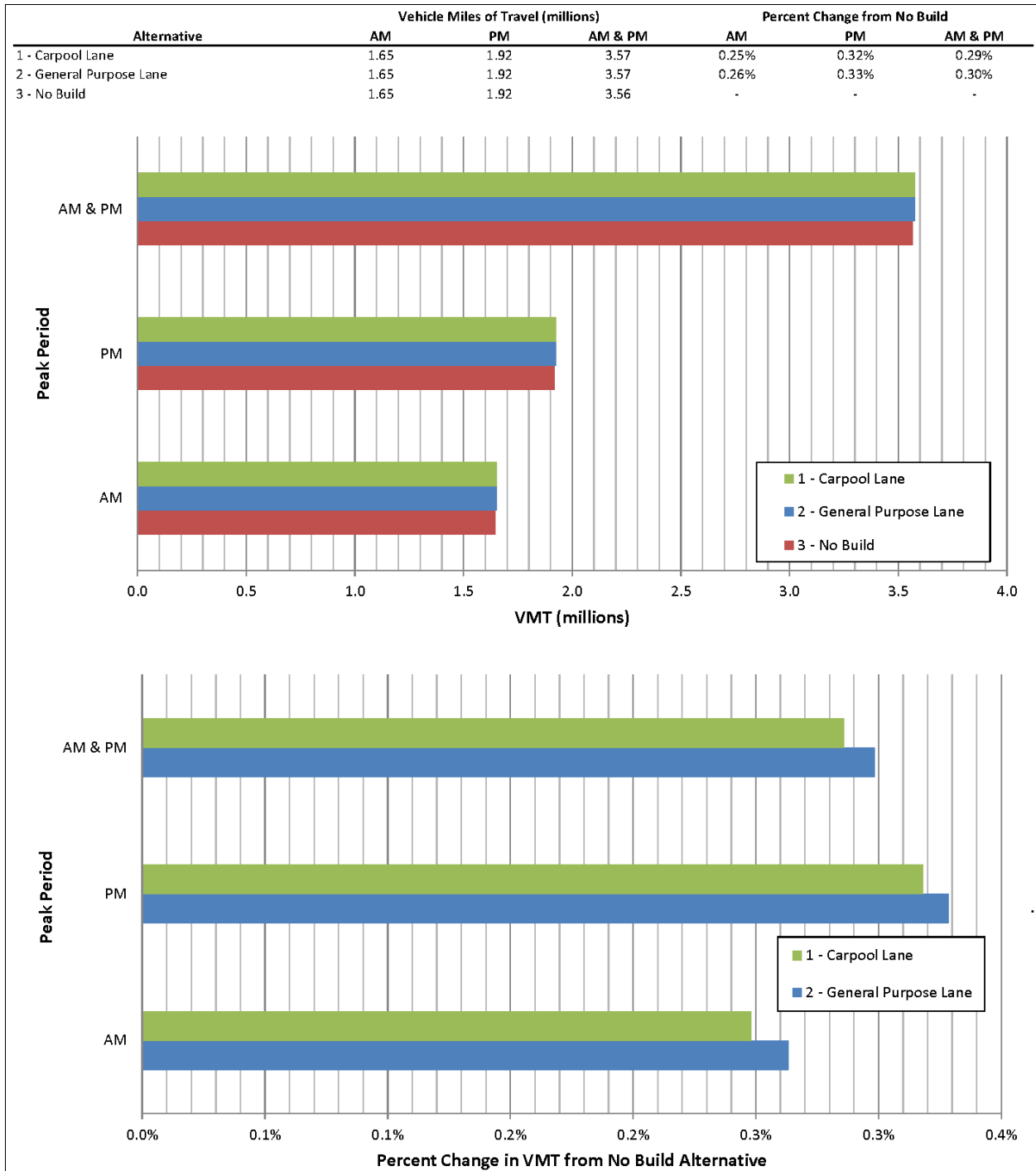

Figure 26 – Construction Year Meso-Scale VMT Comparison

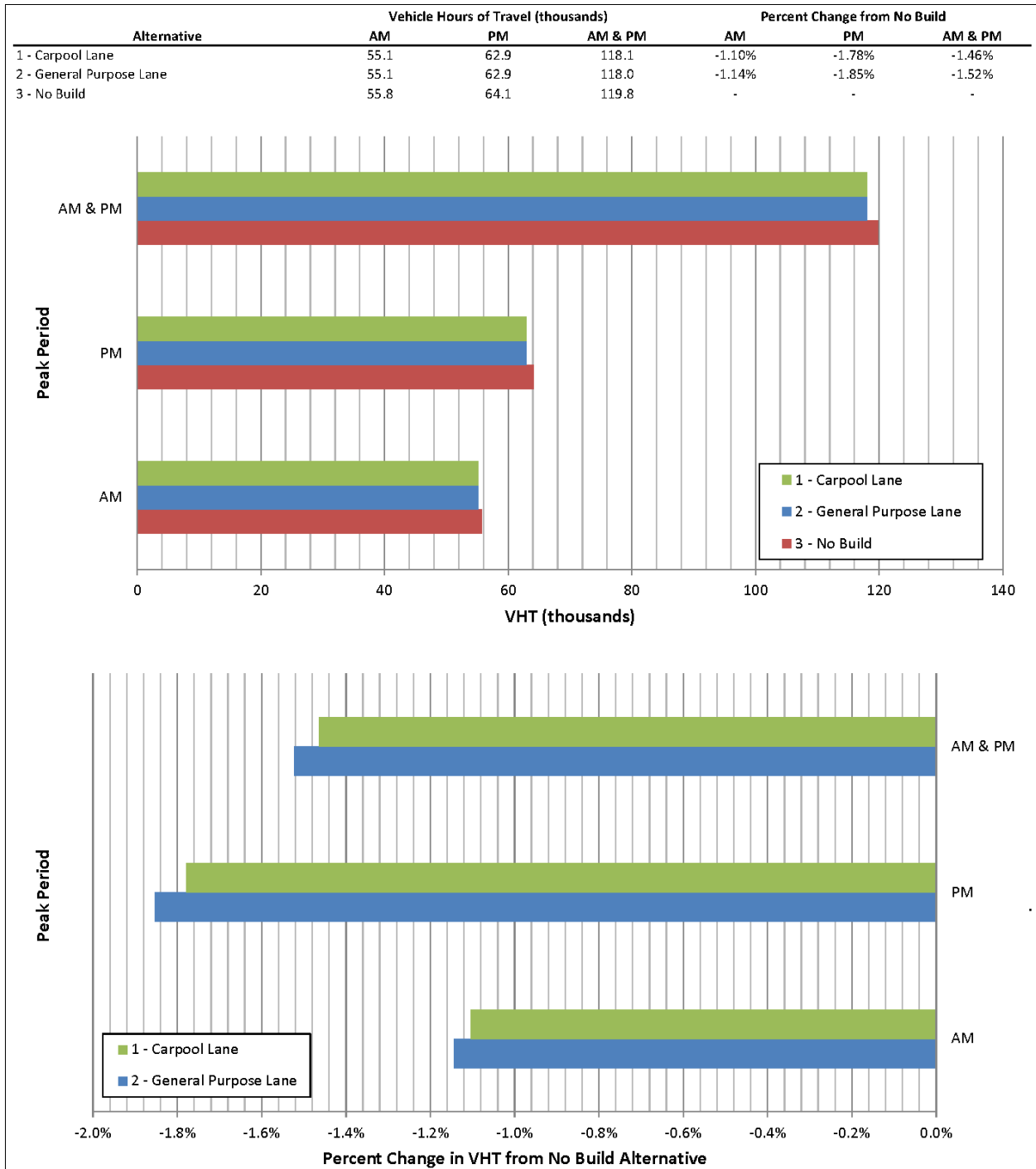

Figure 27 – Construction Year Meso-Scale VHT Comparison

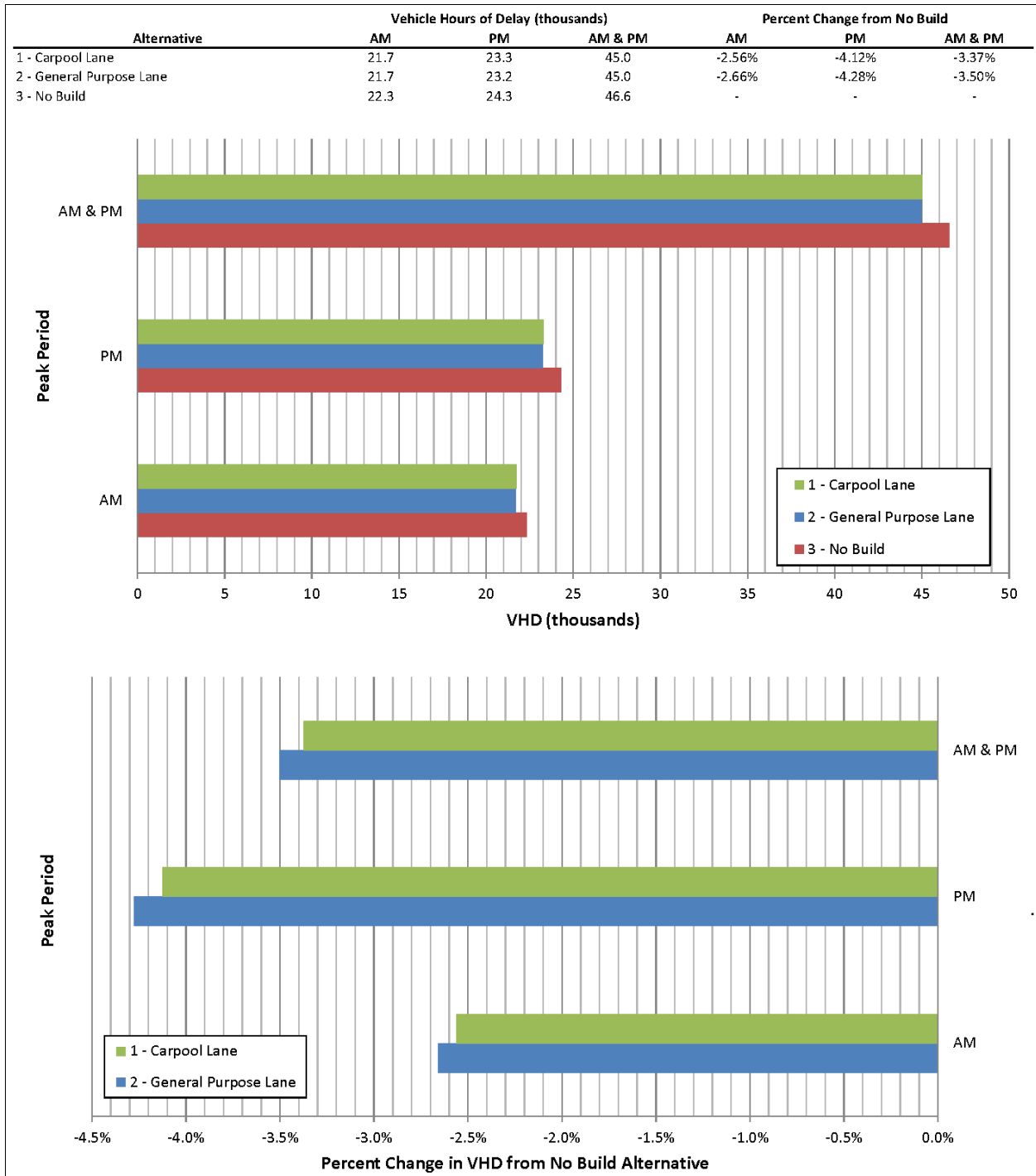

Figure 28 – Construction Year Meso-Scale VHD Comparison

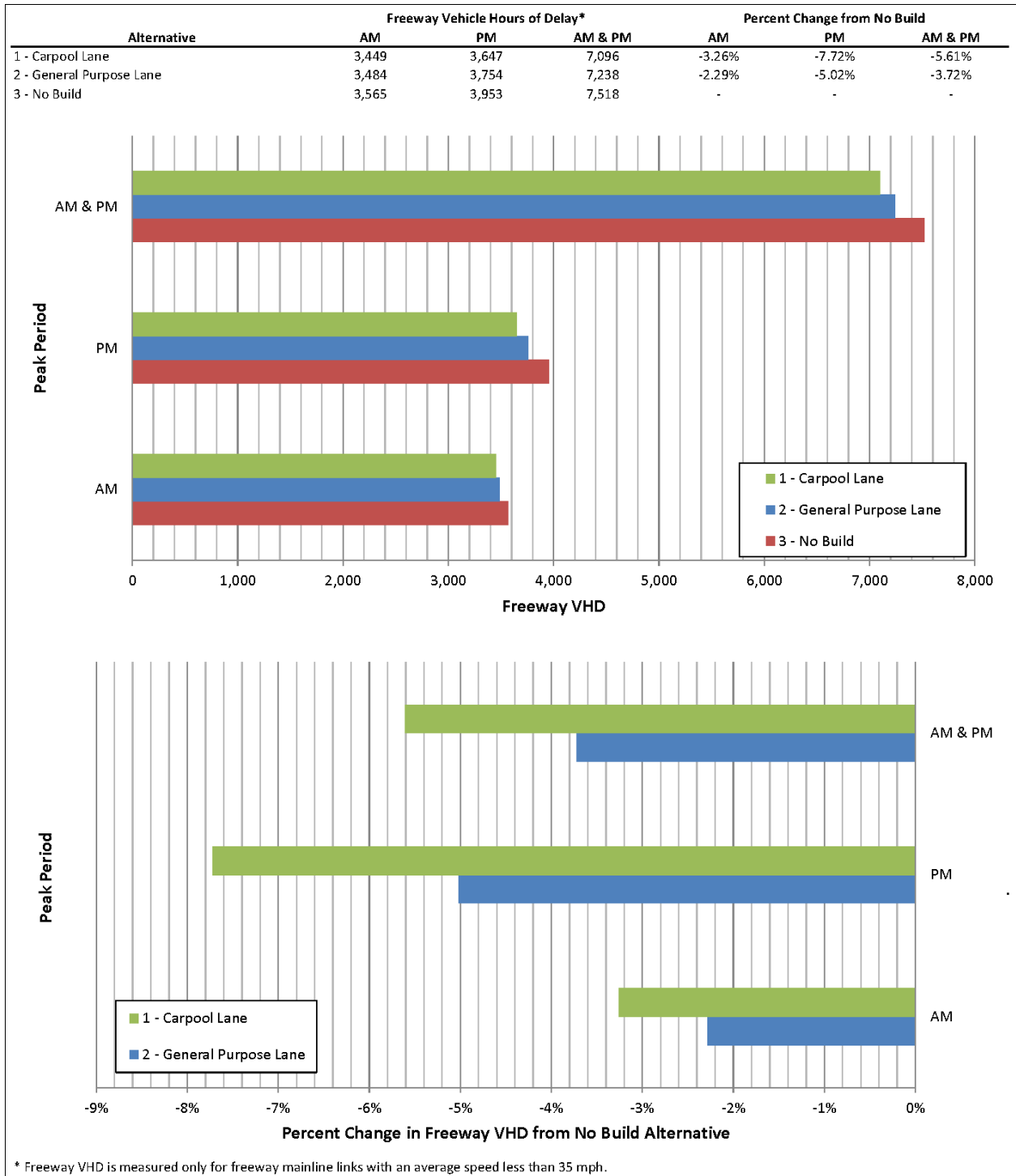

Figure 29 – Construction Year Meso-Scale Freeway VHD Comparison

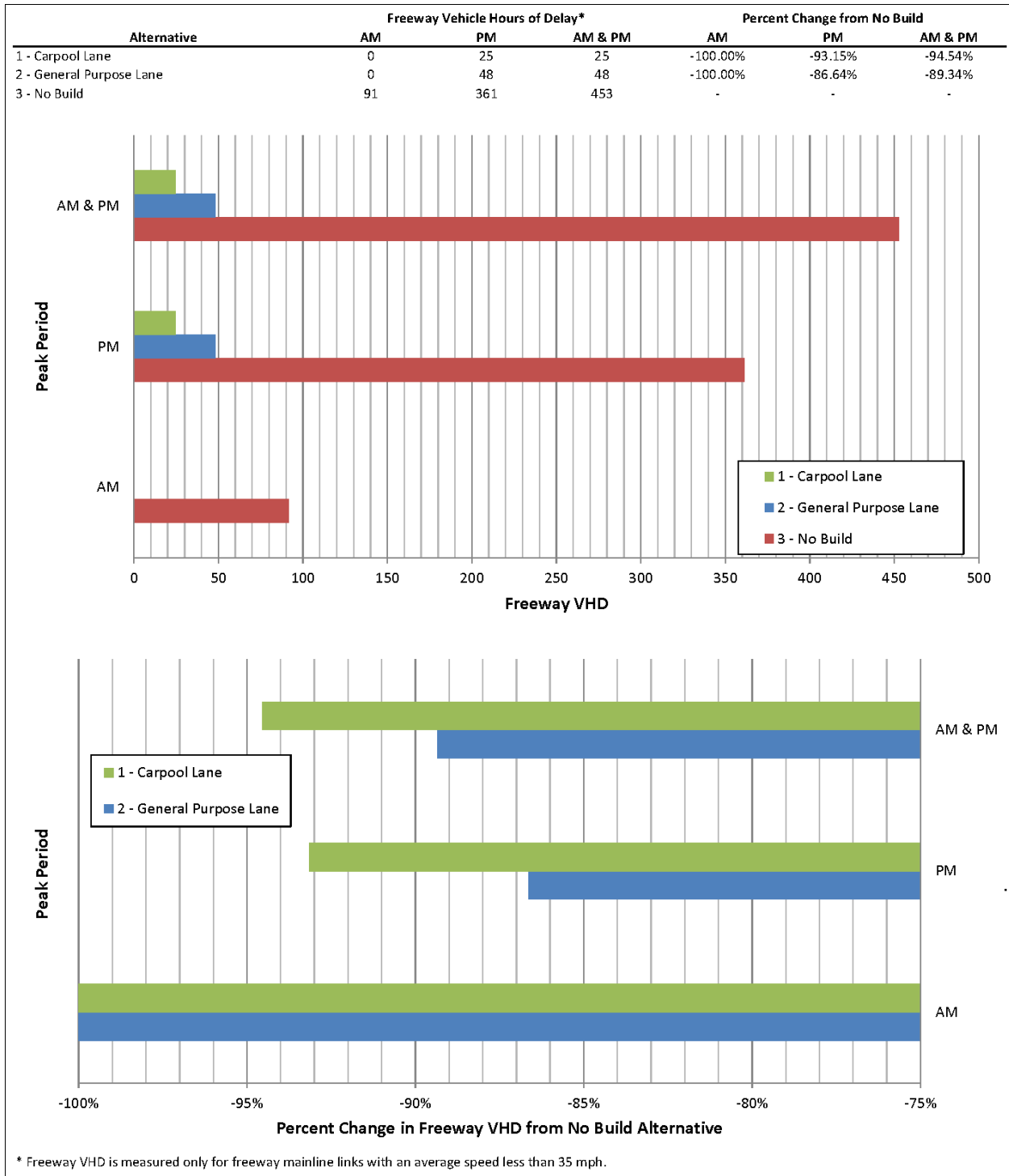

Figure 30 – Construction Year Meso-Scale Project-Area Freeway VHD Comparison

4.2.6. Induced Travel

The phenomenon where additional capacity leads to additional demand for travel is known as “induced travel.” Induced travel occurs when the cost of travel is reduced (i.e., travel time reduction due to additional capacity) causing an increase in demand (more travelers using the improved facility). The reduction in travel time causes various responses by travelers, including diversion from other routes, changes in destinations, changes in mode, departure time shifts, and possibly the creation of new trips all together. As described previously, the SACMET and Visum models have limitations, but they do account for most of the factors that influence induced travel (e.g., changes in route, mode, and destination). The main factors they do not fully account for is the potential generation of new trips and long-term induced land use growth.

Since the SACMET trip generation model was calibrated to 2008 base year conditions when vehicle trip making in the region was not constrained by congestion, pricing, or some other means, the model represents a full level of travel demand being generated by households and employment. This means that new trips being created as a result of a network change are very unlikely because there is no constraint preventing these trips from occurring.

Long-term induced land use growth is the one factor that may not be fully represented because there is no direct feedback process to the land use growth forecasts. However, as part of this project, land use growth was assessed by the PDT. The PDT increased the growth of households and employment in the study area recognizing this area has been planned for additional growth and the transportation improvements associated with this project are intended to help accommodate that growth.

4.2.7. Daily Forecasts

Using the SACMET model files that were the starting point for the peak period forecasts, daily forecasts were prepared for the project alternatives under design year conditions. Table 13 provides the daily mainline volume SR 65 for all vehicles and for trucks in the project area.

TABLE 13: AVERAGE ANNUAL DAILY TRAFFIC VOLUME

Segment	Existing Conditions ¹		Design Year Conditions					
			Alternative 1 (Carpool Lane)		Alternative 2 (GP Lane)		Alternative 3 (No Build)	
	Total	Trucks	Total	Trucks	Total	Trucks	Total	Trucks
I-80 to Galleria Blvd	106,100	3,500	168,100	6,300	169,000	6,400	158,000	6,200
Stanford Ranch Rd/ Galleria Blvd to Pleasant Grove Blvd	104,400	3,500	169,200	6,600	170,900	6,700	152,400	6,300
Pleasant Grove Blvd to Blue Oaks Blvd	83,400	3,100	159,800	6,300	162,300	6,400	140,800	6,000
Blue Oaks Blvd to Sunset Blvd	65,300	2,400	134,600	4,900	135,700	4,900	112,100	4,600
Sunset Blvd to Whitney Ranch Pkwy/ Placer Pkwy	54,000	1,900	114,000	3,700	114,600	3,700	96,900	3,300
Whitney Ranch Pkwy/Placer Pkwy to Twelve Bridges Dr			126,500	3,500	127,000	3,500	112,700	3,400
Twelve Bridges Dr to Lincoln Blvd ²	48,800	1,900	104,300	3,200	104,500	3,200	93,600	3,000
Lincoln Blvd to Ferrari Ranch Rd	-	-	61,100	2,700	61,400	2,700	56,300	2,600
Notes:	¹ The existing conditions total volume data is from 2009 as reported in the PeMS database. The existing truck volumes are estimated from the base year SACMET model. ² The existing condition total volume data from Twelve Bridges Dr to Lincoln Blvd is estimated based on 2009 PeMS data at Sunset Blvd and the base year SACMET model.							
Source:	Fehr & Peers, 2015							

Chapter 5. Traffic Operations Analysis

This section summarizes the traffic operations analysis results based on the Vissim microsimulation traffic operations model (refer to Figure 4 for the Vissim network limits). This analysis provides more detailed insights about peak period and peak hour traffic operations under each alternative. Technical calculations supporting the results can be found in the separately bound Appendix. Design year analysis results are presented first followed by the construction year. All analysis was conducted with the same methodology described in Chapter 2. Further, the evaluation criteria from Chapter 2 were used to identify locations with deficient operations. For these locations, improvements are proposed that may be considered as project refinements or mitigation.

5.1. Design Year Conditions

Overall network performance statistics for AM and PM peak period operations are summarized for each alternative in Tables 14 and 15 below, respectively.

Performance Measure	Existing Conditions	Design Year Conditions			
		Alternative 1	Alternative 2	Alternative 3	
Volume Served (% of total demand)	143,450 (100%)	208,160 (99%)	207,470 (99%)	208,800 (99%)	
Vehicle Miles of Travel (VMT)	645,270	940,220	950,660	917,290	
Person Miles of Travel	786,260	1,113,340	1,133,470	1,094,920	
Vehicle Hours of Travel (VHT)	13,760	21,710	21,960	22,140	
Vehicle Hours of Delay (VHD) (% of VHT)	2,670 (19%)	5,540 (26%)	5,620 (26%)	6,330 (29%)	
Average Delay per Vehicle (min)	1.12	1.60	1.63	1.82	
Person Hours of Delay	3,240	6,320	6,490	7,320	
Average Speed	46.9	43.3	43.3	41.4	
Average Speed for HOVs	47.0	46.4	45.9	44.2	
Travel Time: Ferrari Ranch Rd to I-80	SOV	-	7:49	7:53	11:11
	HOV	-	7:43	7:50	11:02
Travel Time: Blue Oaks Blvd to Antelope Rd	SOV	9:44	8:35	8:37	9:41
	HOV	9:27	8:23	8:29	9:37
Notes:	PMT = person miles of travel, PHD = person hours of delay				
Source:	Fehr & Peers, 2015				

The results presented in Tables 14 and 15 are summarized below.

- Overall, the build alternatives improve network performance compared to the no build alternative.
- The volume served in the network is about the same across alternatives, but the freeway peak hour volumes are lower for Alternative 3 (No Build). This means that Alternative 1 and 2 will have lower local street volume and congestion.
- Alternative 2 (General Purpose Lane) has higher VMT compared to Alternative 1 (Carpool Lane). For the AM peak period, the overall travel time and delay is lower for Alternative 1, but the reverse is true for the PM peak period.
- SOV travel time in the peak direction on SR 65 improves by more than three minutes with the build alternatives (both Alternatives 1 and 2 have similar travel times).
- In general, design year travel time through the I-80/SR 65 interchange would be better than existing conditions for all alternatives due to the separate I-80/SR 65 Interchange Improvements project.

Performance Measure		Existing Conditions	Design Year Conditions		
			Alternative 1	Alternative 2	Alternative 3
Volume Served (% of total demand)		198,170 (101%)	300,780 (100%)	300,820 (100%)	302,580 (99%)
Vehicle Miles of Travel (VMT)		730,100	1,160,700	1,166,400	1,106,390
Person Miles of Travel		880,180	1,402,510	1,402,330	1,328,540
Vehicle Hours of Travel (VHT)		16,850	30,890	30,920	32,920
Vehicle Hours of Delay (VHD) (% of VHT)		3,950 (23%)	10,470 (34%)	10,430 (34%)	13,380 (41%)
Average Delay per Vehicle (min)		1.20	2.09	2.08	2.65
Person Hours of Delay		4,670	12,230	12,160	15,450
Average Speed		43.3	37.6	37.7	33.6
Average Speed for HOVs		44.7	40.5	40.4	37.3
Travel Time: I-80 to Ferrari Ranch Rd	SOV	-	7:52	7:53	11:07
	HOV	-	7:51	7:51	9:34
Travel Time: Auburn Blvd to Blue Oaks Blvd	SOV	9:16	6:31	6:32	11:47
	HOV	9:11	6:20	6:20	6:34
Notes: PMT = person miles of travel, PHD = person hours of delay					
Source: Fehr & Peers, 2015					

Specific details about design year freeway and arterial intersection operations are discussed in more detail in the following sections.

5.1.1. Freeway Operations

Detailed freeway operations analysis was completed for the peak hour (7:30 to 8:30 AM and 4:30 to 5:30 PM) of the four hour AM and PM peak periods. The AM and PM peak-hour served volume are listed in Figure 31. The AM and PM peak hour results for select locations are reported in Tables 16 and 17, respectively. The full set of results is available in the Appendix. Figures 32 through 39 display the average speed in the mixed-flow lanes throughout the network during the peak periods for each alternative.

Northbound SR 65

During the AM peak hour, Alternative 3 (No Build) would have LOS E conditions between Stanford Ranch Road and Pleasant Grove Boulevard. The lane drop at the Pleasant Grove Boulevard off-ramp would be the bottleneck resulting in an average speed between 40 and 50 mph for the peak 15 minutes (see Figure 32). The widening under the build alternatives would provide LOS D or better conditions for the entire corridor.

The PM peak hour would have a significant bottleneck at Pleasant Grove Boulevard under Alternative 3. The resulting congestion would last for longer than three hours and the queue would extend back onto eastbound I-80. The remaining corridor would operate at free-flow speeds. For the build alternatives, northbound SR 65 would have no congestion during the PM peak period.

During both the AM and PM peak hours, northbound SR 65 would operate with LOS E or better conditions under the build alternatives. As a result, the proposed project would not have any impacts.

Southbound SR 65

During the AM peak hour, Alternative 3 would have two major bottlenecks. First, the weave segment between Blue Oaks Boulevard and Pleasant Grove Boulevard would be over capacity for about two hours, resulting in peak-hour LOS F conditions extending upstream to the Sunset Boulevard interchange. Second, the segment between Pleasant Grove Boulevard and Galleria Boulevard would be congested for more than two hours causing slow speeds that would extend into the upstream bottleneck at Blue Oaks Boulevard. As shown in Figure 16, the traffic assignment model is sensitive to the freeway congestion, so more traffic would use local streets than the freeway in Alternative 3.

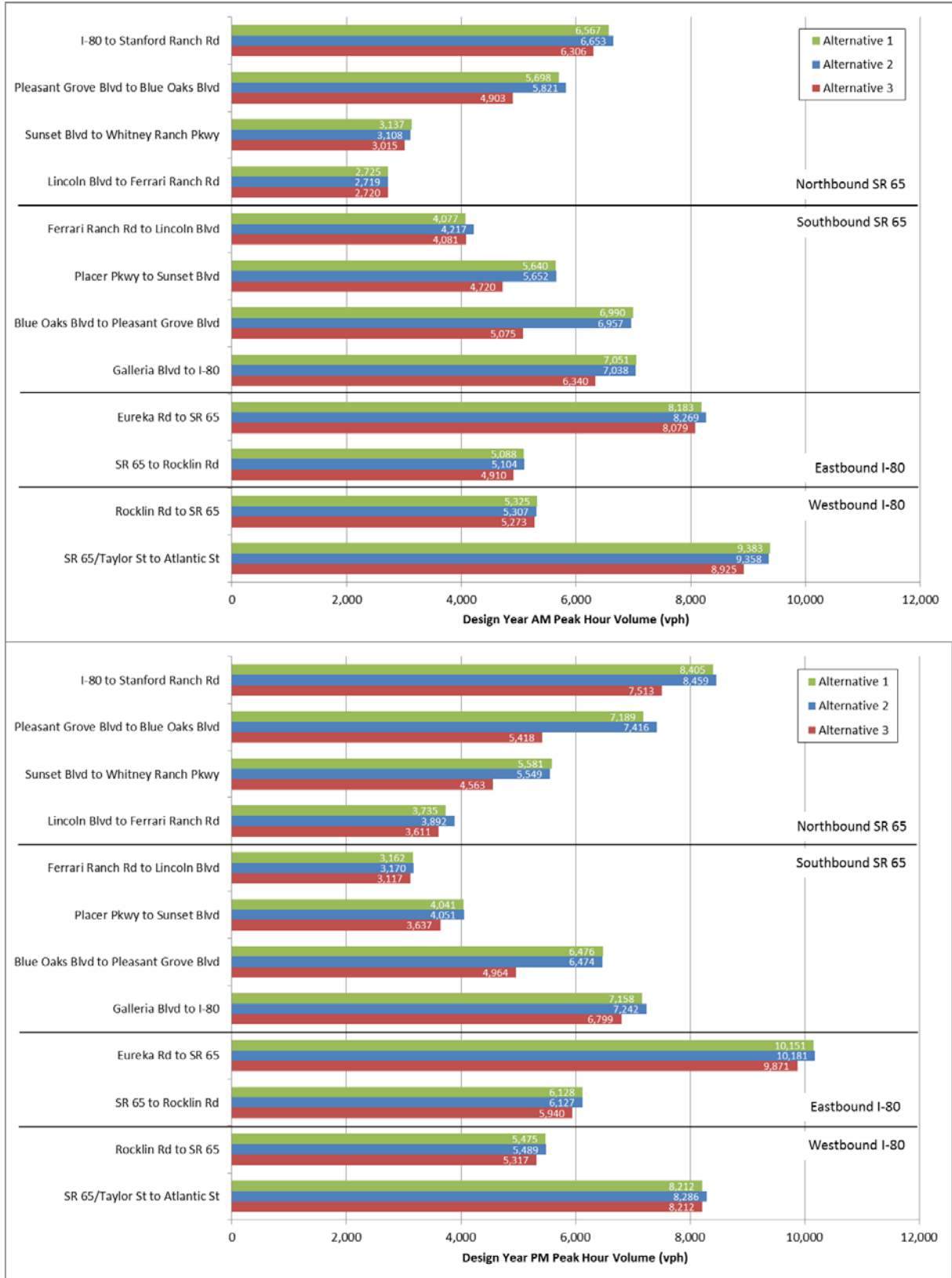
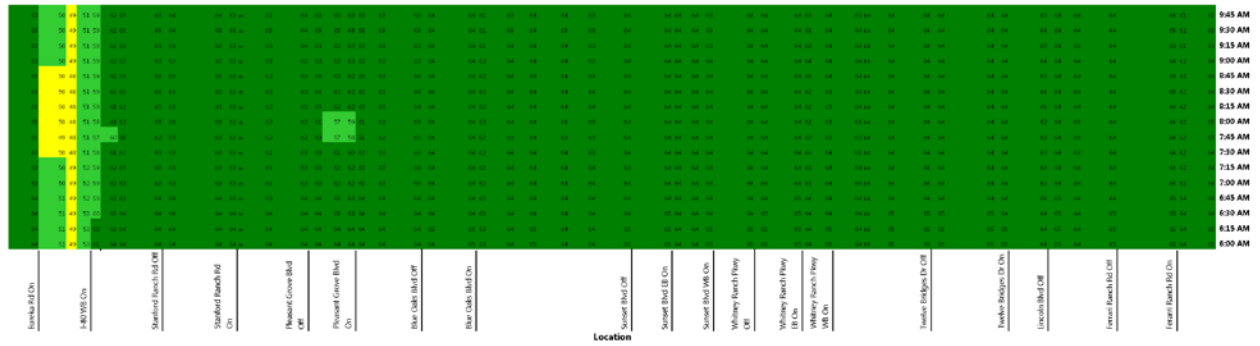

Figure 31 – Freeway Served Volume for Design Year Conditions

TABLE 16: SELECTED FREEWAY OPERATIONS RESULTS – DESIGN YEAR AM PEAK HOUR CONDITIONS					
Freeway	Location	Type¹	Alternative 1	Alternative 2	Alternative 3
NB SR 65	I-80 to Stanford Ranch Rd	Weave	C / 28	C / 28	C / 26
	Stanford Ranch Rd to Pleasant Grove Blvd	Weave	D / 30	D / 30	E / 40
					E / 40
	Pleasant Grove Blvd On-ramp	Merge	D / 31	D / 31	C / 23
	Blue Oaks Blvd Off-ramp	Diverge	C / 27	C / 28	
	Blue Oaks Blvd to Sunset Blvd	Basic	C / 19	C / 19	C / 21
Whitney Ranch Pkwy to Twelve Bridges Dr	Weave	B / 15	B / 16	C / 19	
SB SR 65	Lincoln Blvd to Twelve Bridges Dr	Weave	D / 34	D / 33	D / 28
	Twelve Bridges Dr to Placer Pkwy	Weave	D / 30	D / 29	D / 30
	Sunset Blvd to Blue Oaks Blvd	Weave	D / 34	D / 34	<u>F / 102</u>
	Blue Oaks Blvd WB On-ramp	Merge	D / 32	D / 32	<u>F / 107</u>
	Blue Oaks Blvd to Pleasant Grove Blvd	Weave	D / 33	D / 32	<u>F / 79</u>
				D / 32	
	Pleasant Grove Blvd EB On-ramp	Merge	D / 33	<u>F / 46</u>	<u>F / 82</u>
Pleasant Grove Blvd to Galleria Blvd	Basic	E / 35	E / 36	E / 37	
EB I-80	Auburn Blvd to Douglas Blvd	Basic	E / 39	D / 32	E / 42
	Douglas Blvd to Eureka Rd	Weave	C / 27	C / 23	C / 27
	SR 65 Off-ramp	Diverge	C / 24	C / 22	C / 24
	SR 65 to Rocklin Rd	Basic	C / 26	C / 24	C / 24
WB I-80	Rocklin Rd to Carpool Lane Start	Basic	D / 31	D / 27	D / 30
	SR 65 to Atlantic St	Weave	C / 27	C / 24	C / 25
	Atlantic St On-ramp	Merge	E / 41	E / 36	E / 38
	Douglas Blvd Off-ramp	Diverge	E / 36	D / 32	D / 34
	Douglas Blvd EB On-ramp	Merge	E / 39	D / 31	E / 35
	Riverside Ave Off-ramp	Diverge	D / 35	D / 33	D / 34
	Antelope Rd to Truck Scales	Weave	<u>F / 48</u>	<u>F / 59</u>	<u>F / 70</u>
	Truck Scales On-ramp	Merge	<u>F / 79</u>	<u>F / 88</u>	<u>F / 87</u>
	Elkhorn Blvd EB On-ramp	Merge	<u>F / 91</u>	<u>F / 54</u>	<u>F / 61</u>
Notes: Bold and underline font indicate LOS F conditions. Shaded cells indicate a project impact. The level of service and average density for the study segment are reported.					
¹ The facility type reported is for Alternative 1. The other results are contained in the Technical Appendix.					
Source: Fehr & Peers, 2015					

TABLE 17: SELECTED FREEWAY OPERATIONS RESULTS – DESIGN YEAR PM PEAK HOUR CONDITIONS					
Freeway	Location	Type¹	Alternative 1	Alternative 2	Alternative 3
NB SR 65	I-80 to Stanford Ranch Rd	Weave	D / 33	D / 32	<u>F / 79</u>
	Stanford Ranch Rd to Pleasant Grove Blvd	Weave	D / 33	D / 34	<u>F / 67</u> E / 40
	Pleasant Grove Blvd On-ramp	Merge	D / 33	D / 35	C / 22
	Blue Oaks Blvd Off-ramp	Diverge	D / 31	D / 32	
	Blue Oaks Blvd to Sunset Blvd	Basic	C / 26	C / 26	C / 21
	Whitney Ranch Pkwy to Twelve Bridges Dr	Weave	C / 24	C / 24	C / 24
SB SR 65	Lincoln Blvd to Twelve Bridges Dr	Weave	B / 17	B / 17	B / 17
	Twelve Bridges Dr to Placer Pkwy	Weave	B / 17	C / 22	C / 19
	Sunset Blvd to Blue Oaks Blvd	Weave	C / 24	C / 24	D / 29
	Blue Oaks Blvd WB On-ramp	Merge	C / 27	C / 27	<u>F / 48</u>
	Blue Oaks Blvd to Pleasant Grove Blvd	Weave	C / 28	D / 28 D / 29	<u>F / 48</u>
	Pleasant Grove Blvd EB On-ramp	Merge	D / 30	D / 34	<u>F / 89</u>
	Pleasant Grove Blvd to Galleria Blvd	Basic	D / 34	D / 33	E / 37
EB I-80	Auburn Blvd to Douglas Blvd	Basic	D / 32	E / 36	E / 35
	Douglas Blvd to Eureka Rd	Weave	C / 27	C / 27	E / 41
	SR 65 Off-ramp	Diverge	C / 24	C / 25	<u>F / 58</u>
	SR 65 to Rocklin Rd	Basic	C / 26	D / 27	D / 26
WB I-80	Rocklin Rd to Carpool Lane Start	Basic	D / 30	D / 33	D / 30
	SR 65 to Atlantic St	Weave	C / 23	C / 24	C / 24
	Atlantic St On-ramp	Merge	E / 37	E / 38	E / 39
	Douglas Blvd Off-ramp	Diverge	D / 34	D / 32	D / 32
	Douglas Blvd EB On-ramp	Merge	D / 33	E / 35	E / 36
	Riverside Ave Off-ramp	Diverge	D / 33	D / 34	D / 35
	Antelope Rd to Truck Scales	Weave	C / 26	C / 26	C / 28
	Truck Scales On-ramp	Merge	C / 27	D / 29	D / 29
	Elkhorn Blvd EB On-ramp	Merge	C / 27	C / 28	C / 28
<p>Notes: Bold and underline font indicate LOS F conditions. Shaded cells indicate a project impact. The level of service and average density for the study segment are reported.</p> <p>¹The facility type reported is for Alternative 1. The other results are contained in the Technical Appendix.</p> <p>Source: Fehr & Peers, 2015</p>					

CARPOOL LANE (ALTERNATIVE 1)



GENERAL PURPOSE LANE (ALTERNATIVE 2)

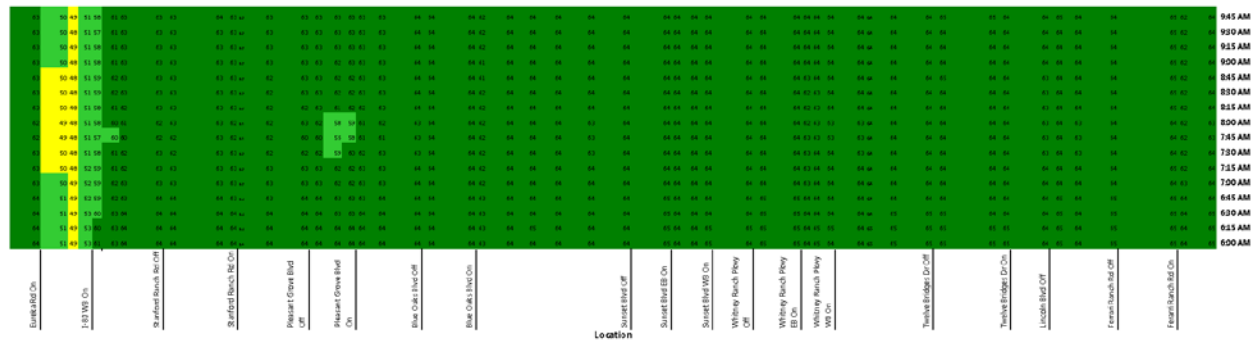

NO BUILD (ALTERNATIVE 3)

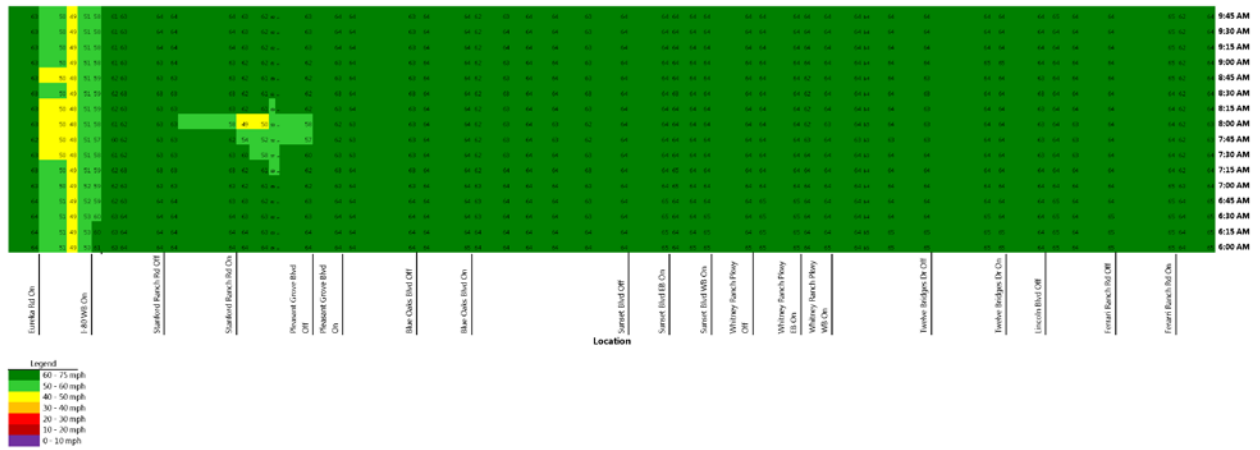
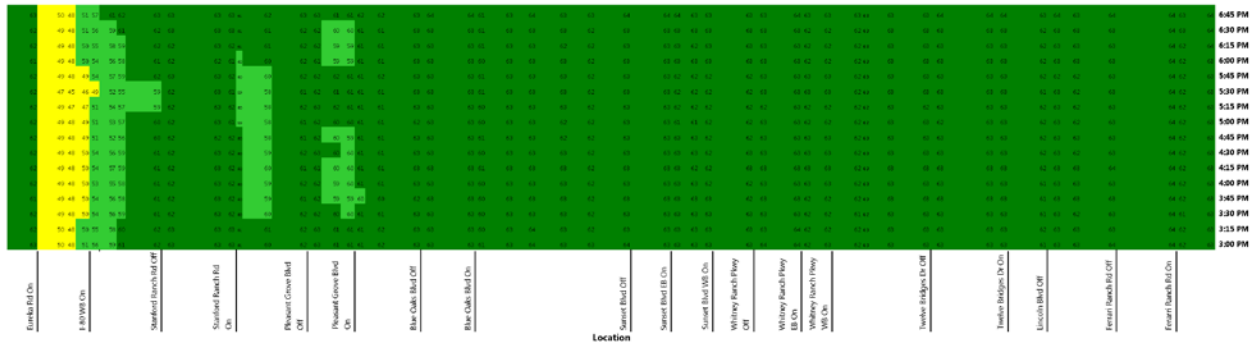
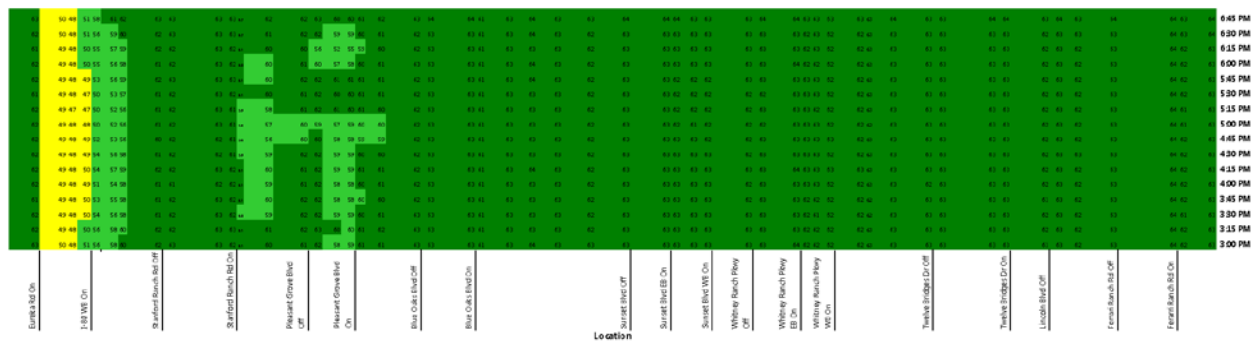

Figure 32 – Northbound SR 65 Design Year AM Peak Period Speed Contour Map

CARPOOL LANE (ALTERNATIVE 1)



GENERAL PURPOSE LANE (ALTERNATIVE 2)



NO BUILD (ALTERNATIVE 3)

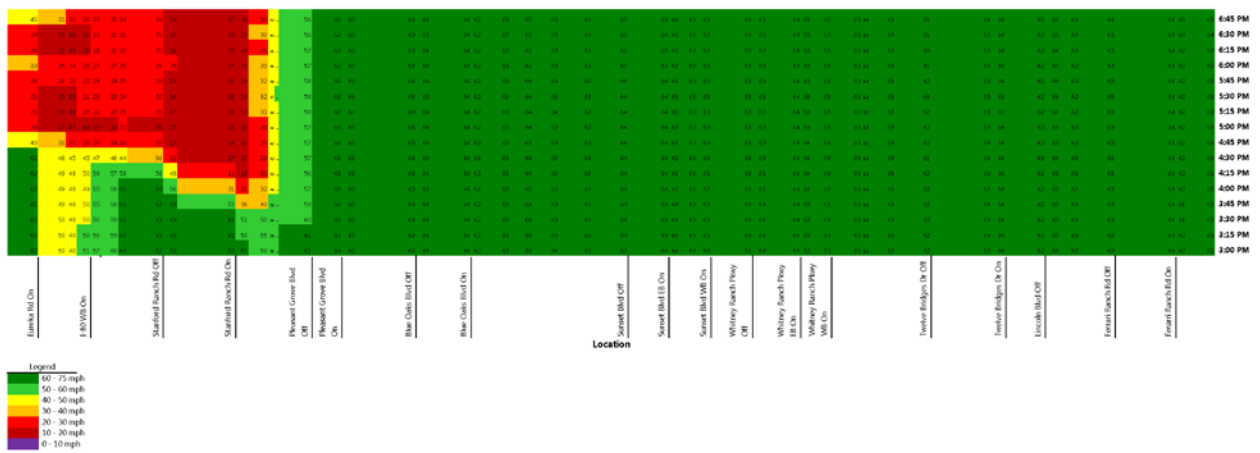
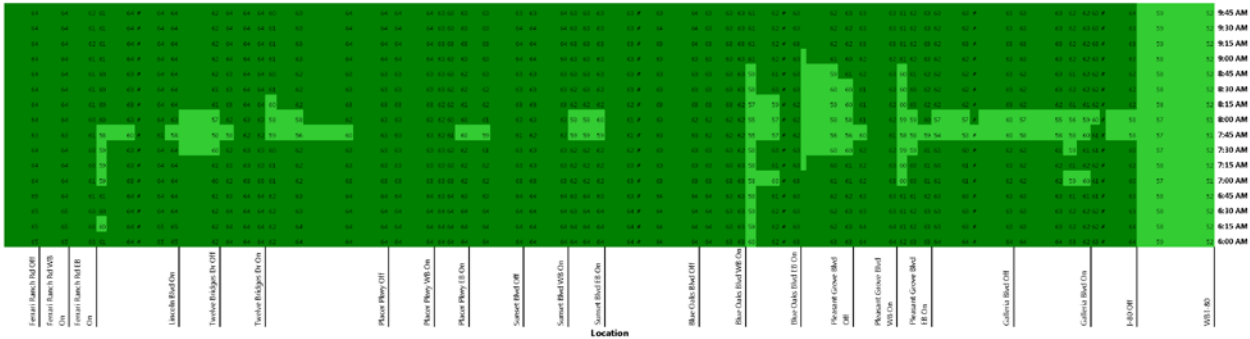
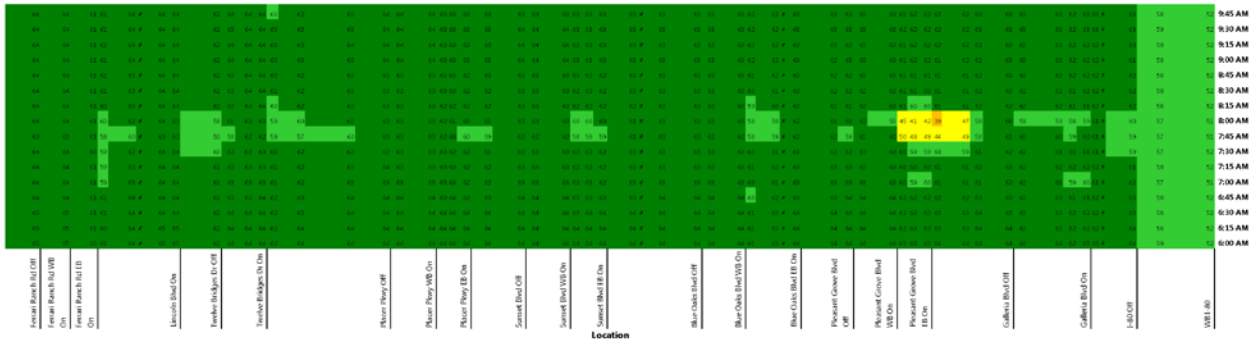

Figure 33 – Northbound SR 65 Design Year PM Peak Period Speed Contour Map

CARPOOL LANE (ALTERNATIVE 1)



GENERAL PURPOSE LANE (ALTERNATIVE 2)



NO BUILD (ALTERNATIVE 3)

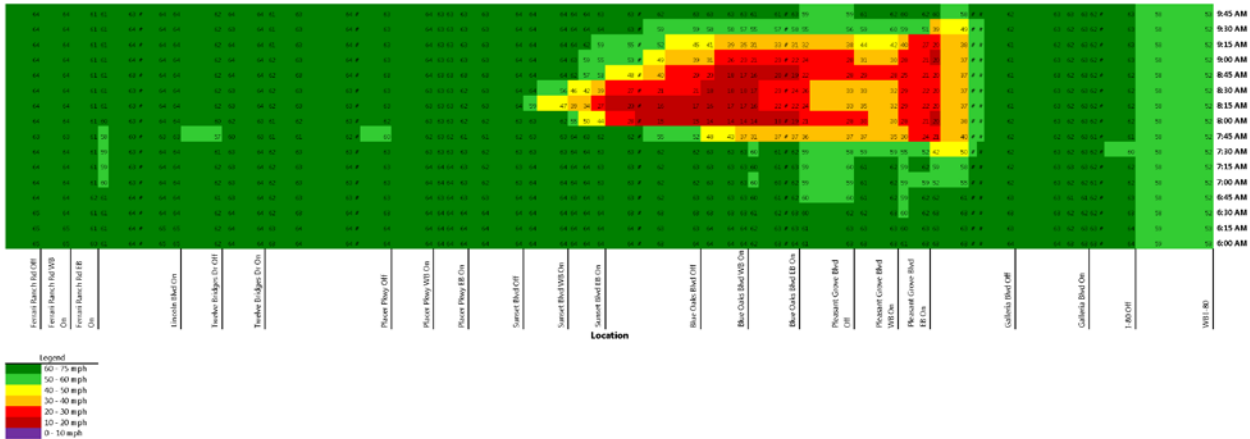
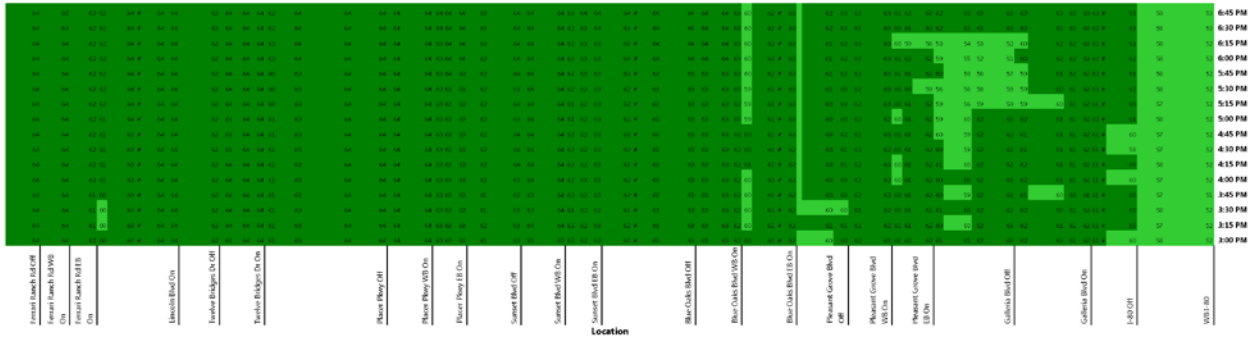
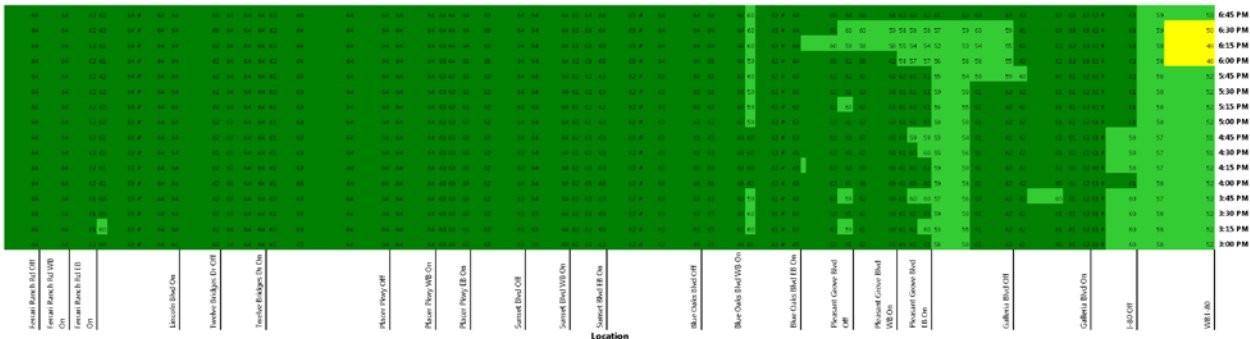

Figure 34 – Southbound SR 65 Design Year AM Peak Period Speed Contour Map

CARPOOL LANE (ALTERNATIVE 1)



GENERAL PURPOSE LANE (ALTERNATIVE 2)



NO BUILD (ALTERNATIVE 3)

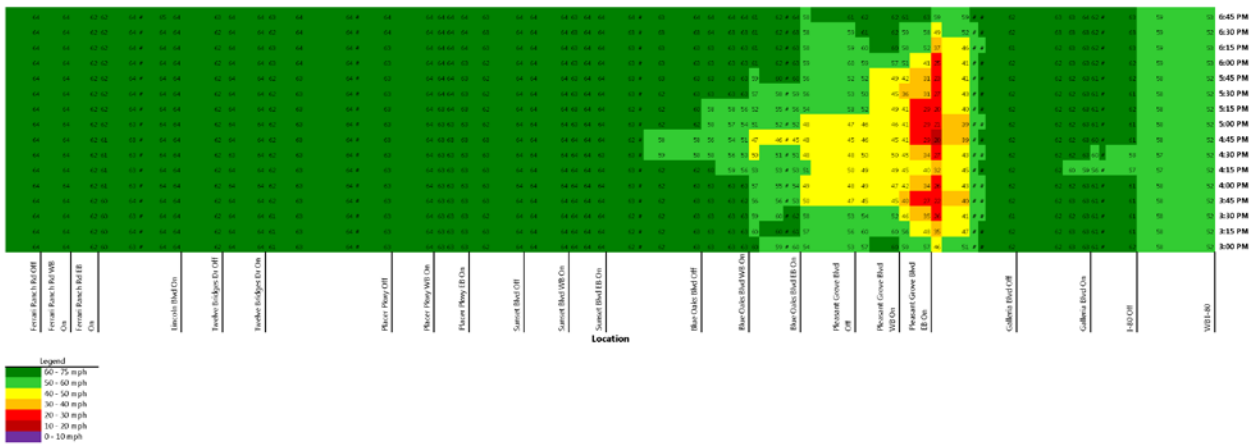
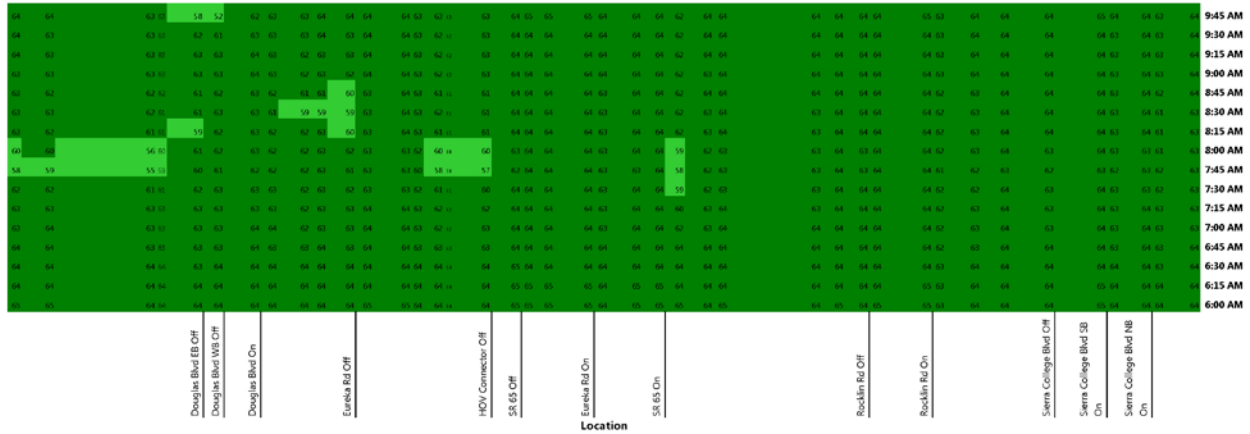
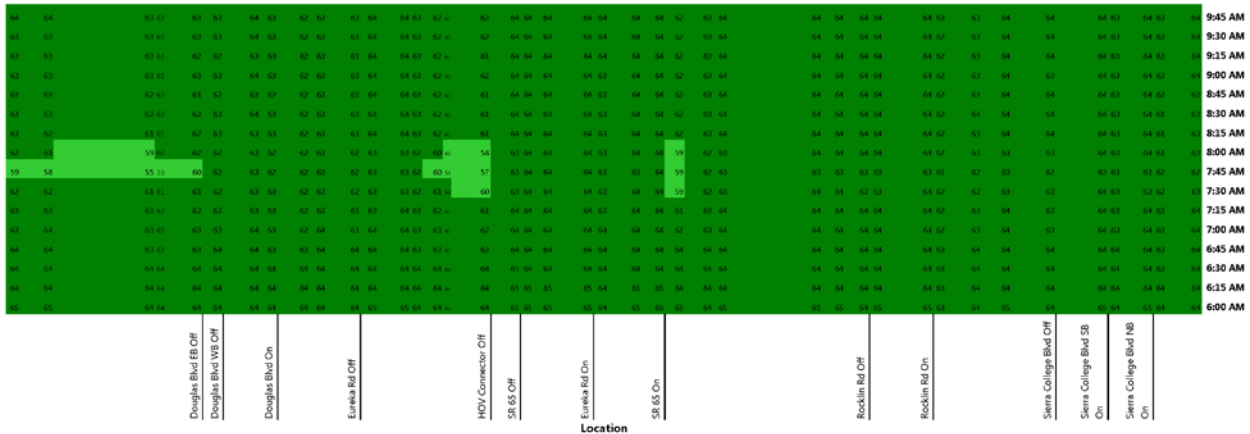

Figure 35 – Southbound SR 65 Design Year PM Peak Period Speed Contour Map

CARPOOL LANE (ALTERNATIVE 1)



GENERAL PURPOSE LANE (ALTERNATIVE 2)



NO BUILD (ALTERNATIVE 3)

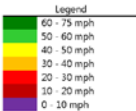
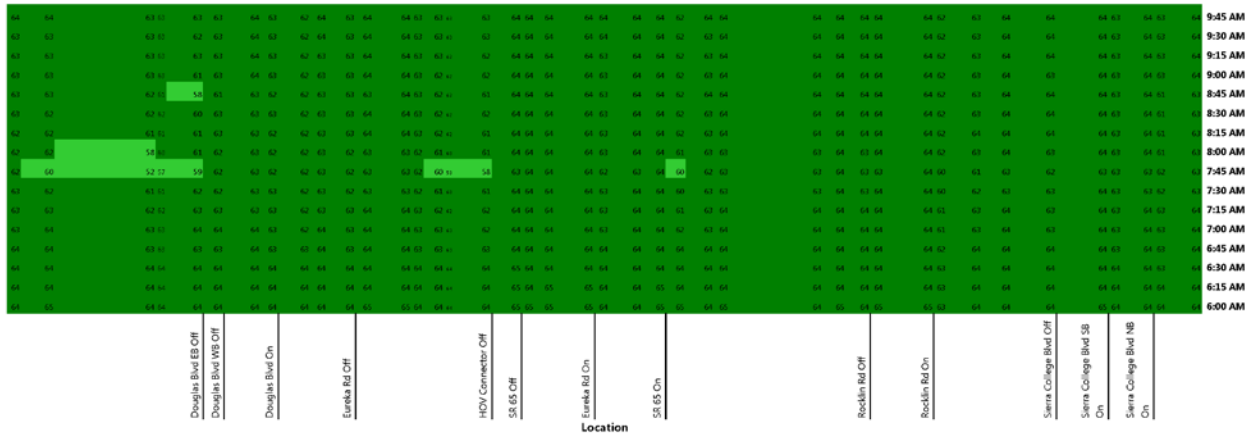
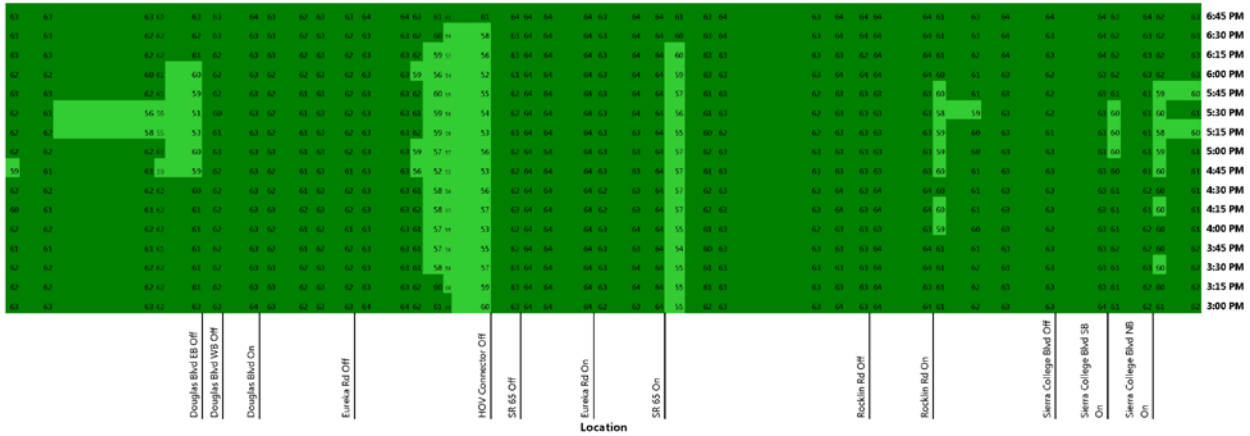
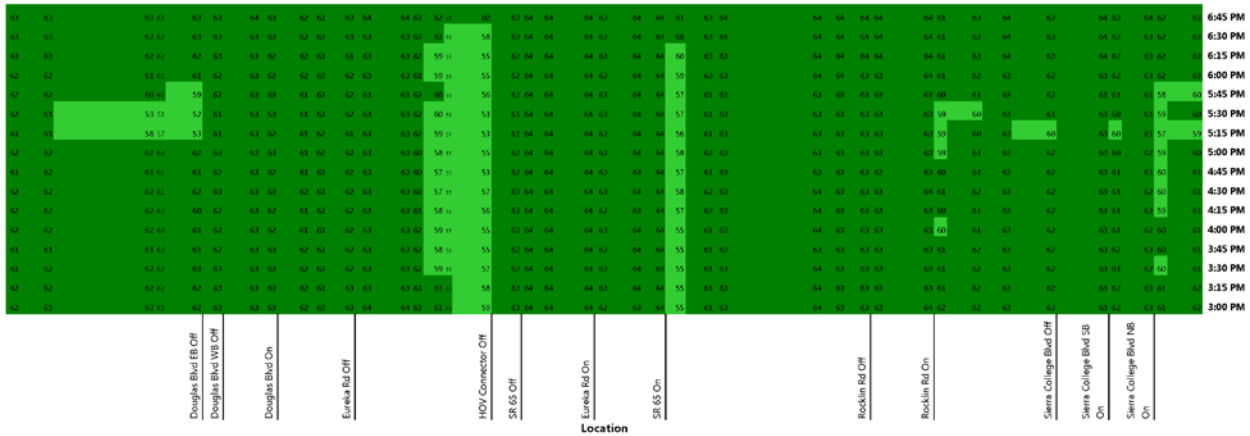

Figure 36 – Eastbound I-80 Design Year AM Peak Period Speed Contour Map

CARPOOL LANE (ALTERNATIVE 1)



GENERAL PURPOSE LANE (ALTERNATIVE 2)



NO BUILD (ALTERNATIVE 3)

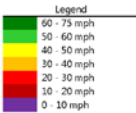
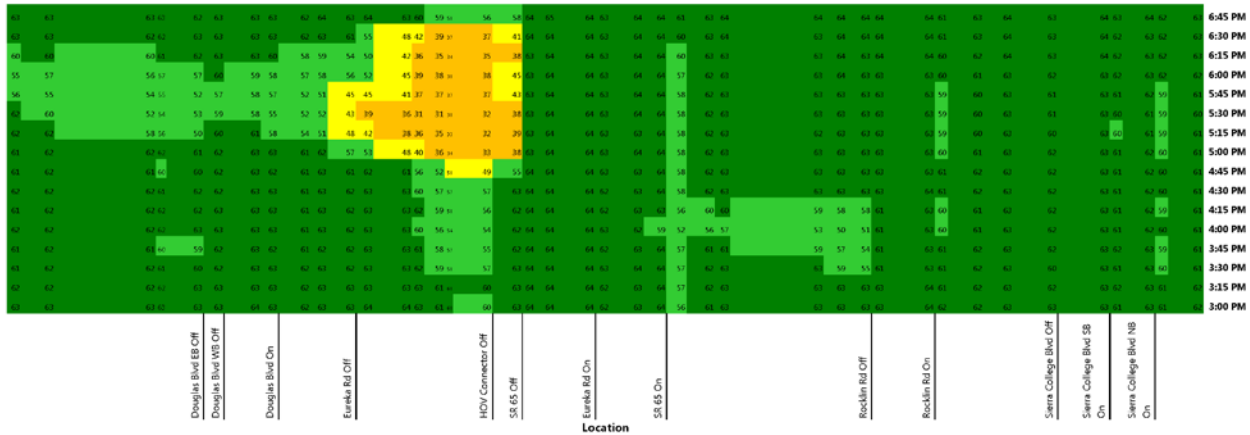
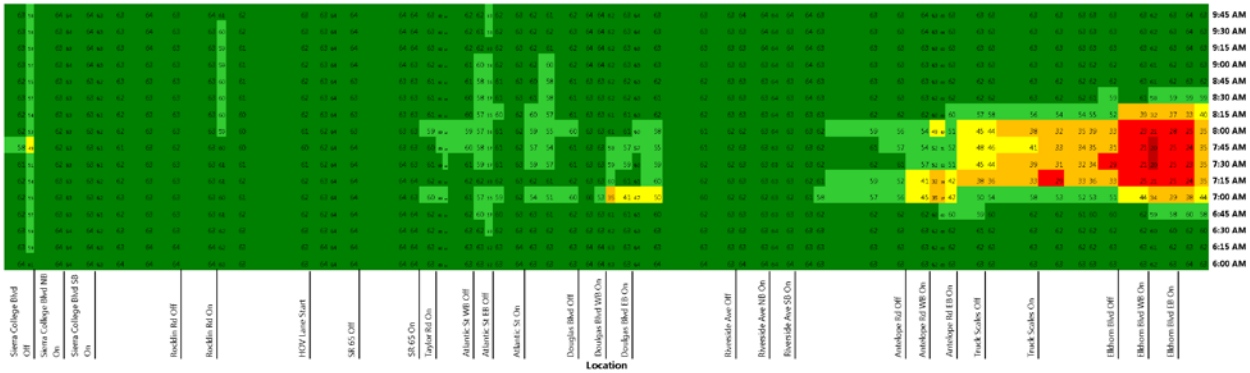
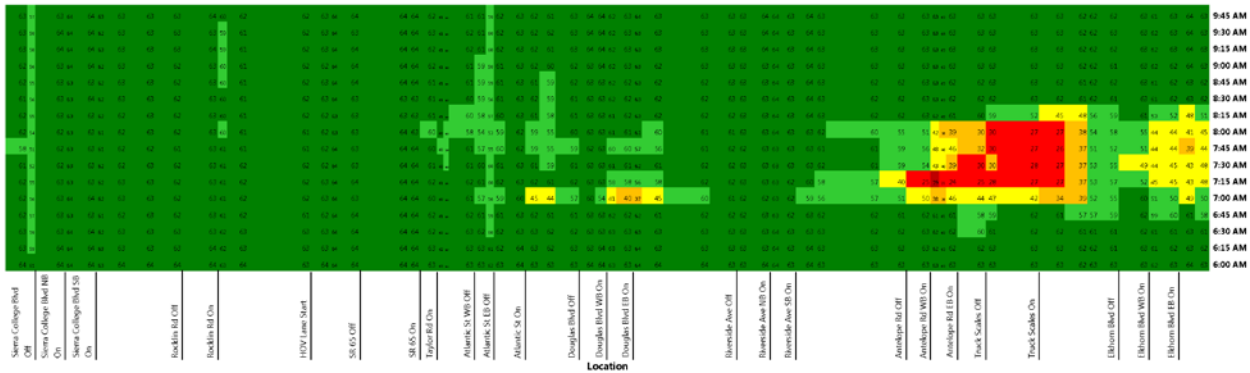

Figure 37 – Eastbound I-80 Design Year PM Peak Period Speed Contour Map

CARPOOL LANE (ALTERNATIVE 1)



GENERAL PURPOSE LANE (ALTERNATIVE 2)



NO BUILD (ALTERNATIVE 3)

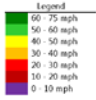
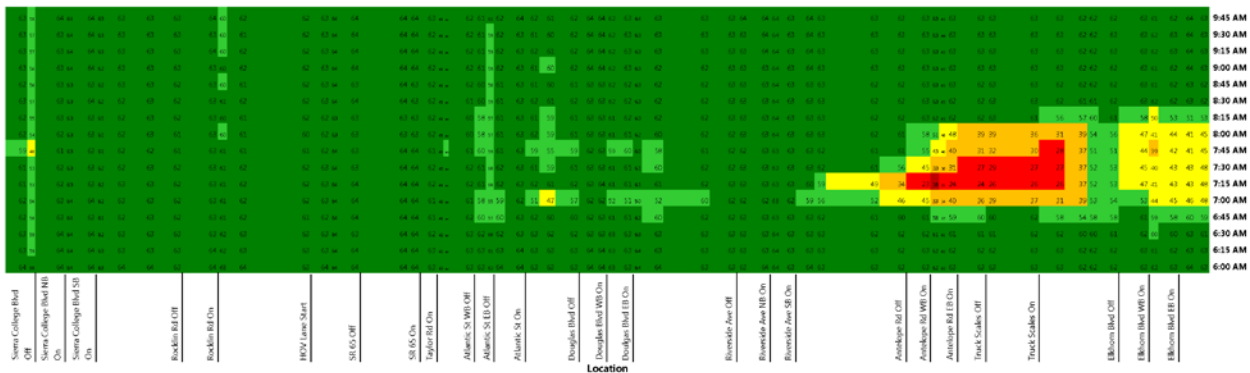
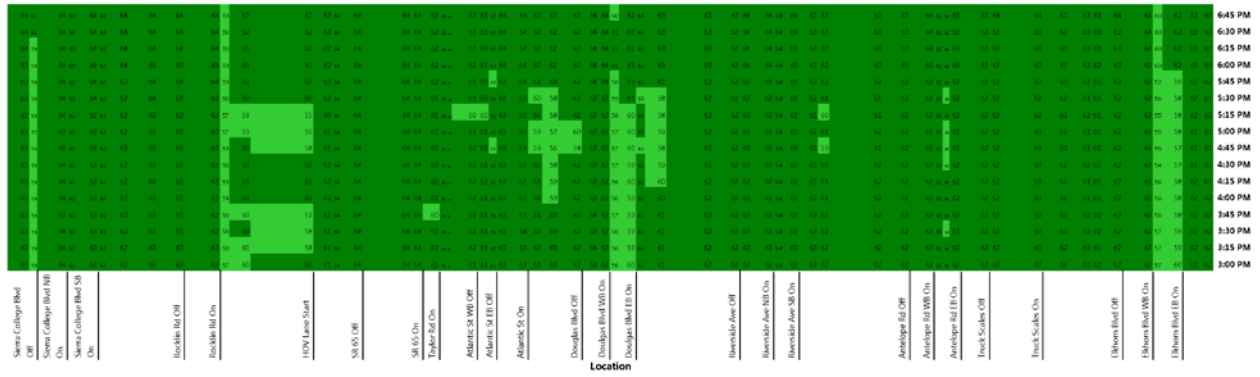
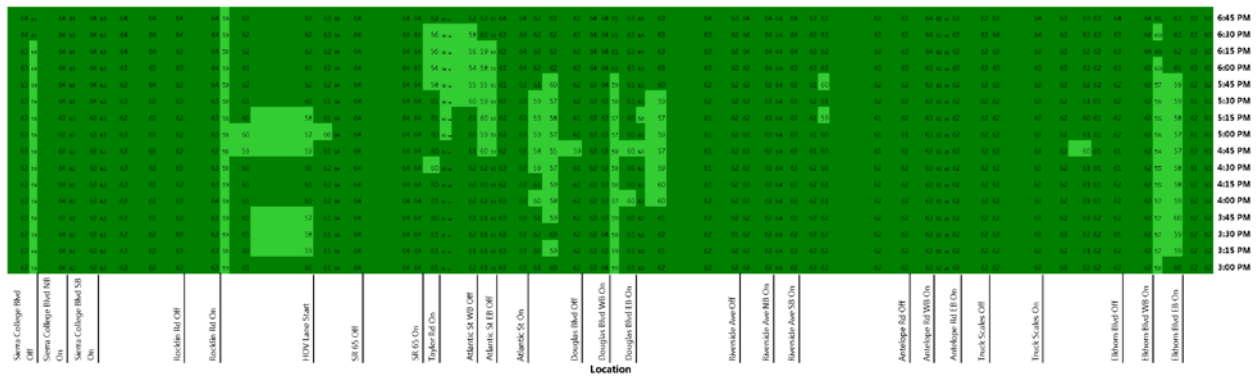

Figure 38 – Westbound I-80 Design Year AM Peak Period Speed Contour Map

CARPOOL LANE (ALTERNATIVE 1)



GENERAL PURPOSE LANE (ALTERNATIVE 2)



NO BUILD (ALTERNATIVE 3)

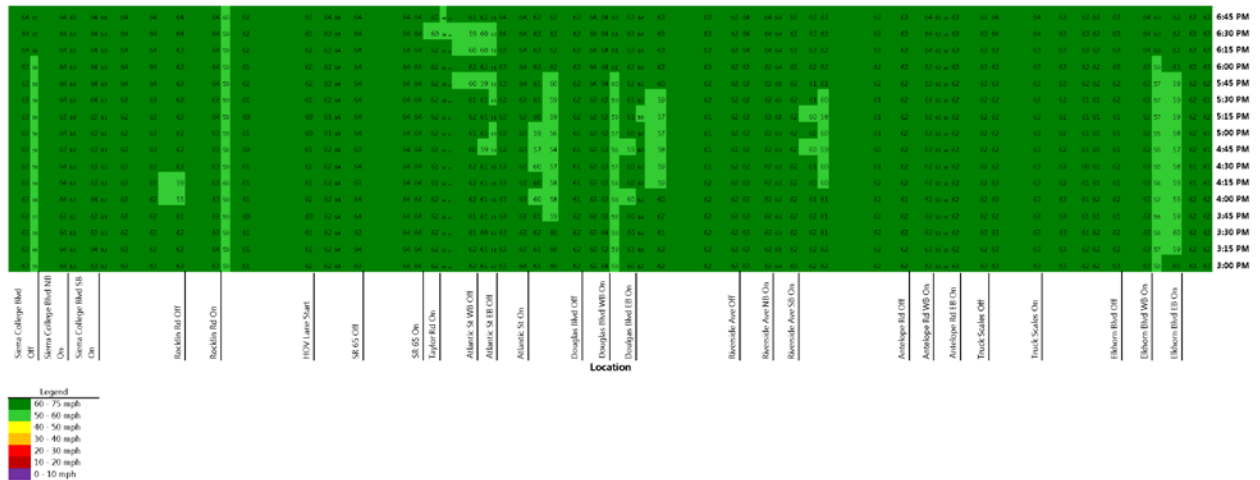

Figure 39 – Westbound I-80 Design Year PM Peak Period Speed Contour Map

For Alternative 2 (General Purpose Lane), LOS F conditions would also occur between Pleasant Grove Boulevard and Galleria Boulevard although the congestion duration would only be about 30 minutes. In the same location, Alternative 1 (Carpool Lane) would operate with LOS E or better conditions. At the bottleneck location between Pleasant Grove Boulevard and Galleria Boulevard, Alternative 1 would have one additional lane – the carpool lane – compared to Alternative 2.

During the PM peak hour, Alternative 3 (No Build) would have only the one bottleneck between Pleasant Grove Boulevard and Galleria Boulevard. The congestion would last for more than three hours and extend upstream to Blue Oaks Boulevard. In this segment, the carpool lane that connects to the median connector ramp at I-80 begins, so the added capacity prevents further congestion. The build alternatives would have LOS E or better conditions with free-flow speeds for southbound SR 65.

Alternative 2 would have deficient LOS F conditions during the PM peak hour between Pleasant Grove Boulevard and Galleria Boulevard. However, Alternative 3 would have worse conditions, so no impact would occur. The deficient operations could be improved by adding mainline capacity such as extending the carpool lane upstream to Blue Oaks Boulevard (as in Alternative 1).

Eastbound I-80

The freeway operations results indicate that all alternatives would operate with LOS E or better conditions during the AM peak hour. During the PM peak period, the No Build alternative would have LOS F operations from the Eureka Road off-ramp to the SR 65 off-ramp. Although the separate I-80/SR 65 Interchange Improvement project would provide sufficient capacity on I-80, the downstream bottleneck on northbound SR 65 at Pleasant Grove Boulevard (discussed above) would cause congestion to extend onto I-80 that would last for about two hours. The average speed in the mixed flow lanes would be less than 40 mph for most of this section.

Both build alternatives would provide significant congestion relief in the PM peak period; therefore, no deficiencies would occur on eastbound I-80. Most segments would operate with LOS D or better conditions during both peak periods.

Westbound I-80

During the AM peak period, congestion would occur between Antelope Road and Elkhorn Boulevard under all three alternatives. However, Alternative 3 (No Build) would have the lowest level of congestion due to upstream bottlenecks on southbound SR 65 that would constrain the demand from reaching the westbound I-80 bottleneck. The proposed project (Alternatives 1 and 2) would result in impacts at the following locations on westbound I-80 in the AM peak hour.

- Truck Scales on-ramp (Alternative 2 only)
- From the Truck Scales on-ramp to the eastbound Elkhorn Boulevard on-ramp (Alternative 1 only)

The impact to the section from the truck scales to Elkhorn Boulevard could be mitigated by providing additional mainline capacity such as a continuous auxiliary lane between the truck scales on-ramp and Elkhorn Boulevard off-ramp or more restrictive metering on-ramps. More restrictive metering for ramps at Elkhorn Boulevard, Antelope Road, and Riverside Avenue could cause queuing that would extend onto the local street network.

During both the AM and PM peak hours, LOS E conditions would occur at isolated locations between Atlantic Street and Douglas Boulevard under all alternatives. However, slow speeds would not last for more than 15 minutes at these locations. As a result, the proposed project would not have impacts during the PM peak hour.

5.1.2. Arterial Intersection Operations

Tables 18 and 19 show the LOS and average delay at key study intersections under design year conditions during the AM and PM peak hours, respectively. Tables 20 and 21 show the average maximum queue length at off-ramps under design year conditions during the AM and PM peak hours. Based on the evaluation criteria for this study, both Alternative 1 (Carpool Lane) Alternative 2 (General Purpose Lane) have four impacts. See the Appendix for all study intersection results.

The following intersections would operate with an unacceptable peak hour LOS based on the evaluation criteria under all project alternatives.

- Blue Oaks Boulevard/Washington Boulevard/SR 65 Southbound Ramps
- Blue Oaks Boulevard/SR 65 Northbound Ramps (PM only)
- Stanford Ranch Road/Five Star Boulevard (PM only)
- Galleria Boulevard/Roseville Parkway (PM only)
- Roseville Parkway/Creekside Ridge Drive (PM only)
- Roseville Parkway/Taylor Road (AM only)
- Eureka Road/Sunrise Avenue
- Douglas Boulevard/I-80 Eastbound Ramps (PM only)
- Douglas Boulevard/Sunrise Avenue (PM only)
- Rocklin Road/Granite Drive (PM only)
- Rocklin Road/I-80 Westbound Ramps (PM only)

TABLE 18: INTERSECTION OPERATIONS RESULTS – DESIGN YEAR AM PEAK HOUR CONDITIONS				
Intersection	Threshold	Alternative 1	Alternative 2	Alternative 3
6. Blue Oaks Blvd / Washington Blvd / SR 65 SB Ramps	C	<u>E / 57</u>	<u>E / 59</u>	<u>F / 90</u>
7. Blue Oaks Blvd / SR 65 NB Ramps	C	B / 17	B / 16	B / 17
10. Stanford Ranch Rd / Five Star Blvd	C	C / 27	C / 26	C / 26
11. Stanford Ranch Rd / SR 65 NB Ramps	D	B / 11	B / 12	B / 19
12. Galleria Blvd / SR 65 SB Ramps	D	B / 19	B / 17	D / 55
13. Galleria Blvd / Antelope Creek Dr	C	A / 10	A / 10	A / 8
14. Galleria Blvd / Roseville Pkwy	E	D / 47	D / 45	D / 41
15. Roseville Pkwy / Creekside Ridge Dr	C	A / 8	A / 8	A / 8
16. Roseville Pkwy / Taylor Rd	D	<u>E / 70</u>	<u>E / 66</u>	<u>E / 60</u>
17. Roseville Pkwy / Sunrise Ave	E	C / 33	C / 35	C / 33
20. Eureka Rd / Taylor Rd / I-80 EB Ramps	E	C / 30	C / 30	C / 30
21. Eureka Rd / Sunrise Ave	C	<u>D / 41</u>	<u>D / 41</u>	<u>D / 41</u>
23. Douglas Blvd / Harding Blvd	E	C / 26	C / 28	C / 26
24. Douglas Blvd / I-80 WB Ramps	C	C / 21	B / 19	C / 22
25. Douglas Blvd / I-80 EB Ramps	C	C / 28	C / 24	C / 29
26. Douglas Blvd / Sunrise Ave	D	D / 54	D / 44	D / 43
29. Rocklin Rd / Granite Dr	C	C / 29	C / 28	C / 26
30. Rocklin Rd / I-80 WB Ramps	C	C / 23	C / 24	C / 22
31. Rocklin Rd / I-80 EB Ramps	C	C / 30	C / 26	<u>D / 41</u>
<p>Note: Bold and underline font indicate unacceptable operations. Shaded cells indicate a project impact. The LOS and average delay in seconds per vehicle are reported.</p> <p>Source: Fehr & Peers, 2015</p>				

TABLE 19: INTERSECTION OPERATIONS RESULTS – DESIGN YEAR PM PEAK HOUR CONDITIONS				
Intersection	Threshold	Alternative 1	Alternative 2	Alternative 3
6. Blue Oaks Blvd / Washington Blvd / SR 65 SB Ramps	C	<u>F / 140</u>	<u>F / 153</u>	<u>F / 214</u>
7. Blue Oaks Blvd / SR 65 NB Ramps	C	<u>D / 45</u>	<u>D / 49</u>	<u>F / 94</u>
10. Stanford Ranch Rd / Five Star Blvd	C	<u>F / 82</u>	<u>E / 57</u>	<u>F / 85</u>
11. Stanford Ranch Rd / SR 65 NB Ramps	D	D / 36	B / 19	C / 21
12. Galleria Blvd / SR 65 SB Ramps	D	C / 25	B / 19	C / 27
13. Galleria Blvd / Antelope Creek Dr	C	C / 28	C / 29	C / 28
14. Galleria Blvd / Roseville Pkwy	E	<u>F / 93</u>	<u>F / 82</u>	<u>F / 93</u>
15. Roseville Pkwy / Creekside Ridge Dr	C	<u>D / 50</u>	<u>D / 47</u>	<u>D / 50</u>
16. Roseville Pkwy / Taylor Rd	D	D / 52	D / 52	<u>E / 55</u>
17. Roseville Pkwy / Sunrise Ave	E	E / 70	E / 57	<u>F / 89</u>
20. Eureka Rd / Taylor Rd / I-80 EB Ramps	E	E / 75	<u>F / 81</u>	<u>F / 99</u>
21. Eureka Rd / Sunrise Ave	C	<u>F / 94</u>	<u>F / 103</u>	<u>F / 104</u>
23. Douglas Blvd / Harding Blvd	E	<u>F / 91</u>	<u>F / 96</u>	E / 69
24. Douglas Blvd / I-80 WB Ramps	C	C / 28	C / 33	C / 20
25. Douglas Blvd / I-80 EB Ramps	C	<u>D / 37</u>	<u>D / 37</u>	<u>D / 39</u>
26. Douglas Blvd / Sunrise Ave	D	<u>F / 254</u>	<u>F / 241</u>	<u>F / 239</u>
29. Rocklin Rd / Granite Dr	C	<u>F / 95</u>	<u>F / 84</u>	<u>F / 101</u>
30. Rocklin Rd / I-80 WB Ramps	C	<u>E / 68</u>	<u>E / 63</u>	<u>D / 54</u>
31. Rocklin Rd / I-80 EB Ramps	C	C / 21	B / 20	C / 21
<p>Note: Bold and underline font indicate unacceptable operations. Shaded cells indicate a project impact. The LOS and average delay in seconds per vehicle are reported.</p> <p>Source: Fehr & Peers, 2015</p>				

TABLE 20: SELECTED MAXIMUM QUEUE LENGTH RESULTS – DESIGN YEAR AM PEAK HOUR CONDITIONS			
Off-ramp	Storage	Alternative 1	Alternative 2
Eastbound I-80 at Eureka Rd	1,700	700	500
Eastbound I-80 at Rocklin Rd	1,080	325	300
Northbound SR 65 at Northbound Stanford Ranch Rd	1,170	200	200
Northbound SR 65 at Southbound Stanford Ranch Rd	1,800	25	25
Northbound SR 65 at Pleasant Grove Blvd	1,170	200	200
Northbound SR 65 at Blue Oaks Blvd	1,100	325	300
Northbound SR 65 at Sunset Blvd	1,400	225	250
Southbound at Blue Oaks Blvd	2,260	1,425	975
Southbound at Pleasant Grove Blvd	1,130	200	175
Southbound SR 65 at Southbound Galleria Blvd	1,130	375	400
Southbound SR 65 at Northbound Galleria Blvd	1,780	50	50
Note: Bold and underline font indicate queues that exceed the ramp length. Shaded cells indicate a project impact. The reported value is the average maximum peak-hour queue length in feet. Source: Fehr & Peers, 2015			

TABLE 21: SELECTED MAXIMUM QUEUE LENGTH RESULTS – DESIGN YEAR PM PEAK HOUR CONDITIONS			
Off-ramp	Storage	Alternative 1	Alternative 2
Eastbound I-80 at Eureka Rd	1,700	350	400
Eastbound I-80 at Rocklin Rd	1,080	325	300
Northbound SR 65 at Northbound Stanford Ranch Rd	1,170	475	325
Northbound SR 65 at Southbound Stanford Ranch Rd	1,800	25	25
Northbound SR 65 at Pleasant Grove Blvd	1,170	225	200
Northbound SR 65 at Blue Oaks Blvd	1,100	250	275
Northbound SR 65 at Sunset Blvd	1,400	250	250
Southbound at Blue Oaks Blvd	2,260	900	850
Southbound at Pleasant Grove Blvd	1,130	150	150
Southbound SR 65 at Southbound Galleria Blvd	1,130	400	400
Southbound SR 65 at Northbound Galleria Blvd	1,780	325	175
Note: Bold and underline font indicate queues that exceed the ramp length. Shaded cells indicate a project impact. The reported value is the average maximum peak-hour queue length in feet. Source: Fehr & Peers, 2015			

To operate within the established LOS thresholds for these locations, capacity enhancements or peak period travel demand management strategies would need to be employed in the study area with and without the proposed project. Before any improvements are proposed though, the interaction between these locations and the rest of the network should be considered. In some cases, the operation of these intersections meters traffic accessing the freeway. This may be desirable in certain locations, such as at Blue Oaks Boulevard/Washington Boulevard. In other locations, improvements to the freeway system, such as an auxiliary lane, may reduce demand and/or queuing that would improve intersection operations.

During the AM peak hour, the proposed project (Alternatives 1 and 2) would have impacts at Roseville Parkway/Taylor Road. The impact may be mitigated by adjusting signal timing. Since the intersection already has right-turn overlap phases and dual left-turn lanes, further improvements could include a fourth east or westbound through lane or a third southbound left-turn lane.

During the PM peak hour, the proposed project (Alternatives 1 and 2) would have impacts at the following study intersections.

- Douglas Boulevard/Harding Boulevard
- Douglas Boulevard/Sunrise Avenue
- Rocklin Road / I-80 Westbound Ramps

Potential improvements for the Douglas Boulevard corridor include an additional eastbound lane at Harding Boulevard and a second southbound right turn lane at Sunrise Avenue to provide additional capacity. At Rocklin Road, extending the eastbound right-turn movement storage further upstream would reduce overall intersection delay. Providing additional storage on the westbound on-ramp would also help to reduce queuing from the ramp meter onto Rocklin Road.

During the peak hours, the average maximum queue lengths for freeway off-ramps at all study intersections are less than the ramp storage length under both build alternatives. Due to congested conditions at the ramp terminal intersection, the southbound off-ramp queue at Blue Oaks Boulevard may be 1,000 feet or more during the PM peak hour. However, the off-ramp provides more than 2,000 feet of storage, so mainline operations would not be affected.

5.1.3. Ramp Meter Operations

The proposed project will install or reconstruct ramp meters for on-ramps in the project area. An analysis of the ramp meter storage for these ramps was conducted to determine the appropriate number of general purpose lanes and whether a HOV preferential should be provided.

Table 22 shows the existing and proposed ramp configuration. The existing configuration refers to the number of ramp lanes and striping/striping for HOV lane restrictions. Ramp meters are active during the AM and PM peak periods only in the southbound direction at the Blue Oaks Boulevard eastbound on-ramp and at the Pleasant Grove Boulevard westbound and eastbound on-ramps. Technical calculations for determining ramp meter storage based on the 15-minute arrival rates during the peak periods are provided in the appendix.

TABLE 22: SR 65 RAMP CONFIGURATION					
Ramp		Existing		Proposed	
		Lanes	HOV	Lanes	HOV
Northbound	Stanford Ranch Rd ¹	1	No	3	Yes
	Pleasant Grove Blvd	2	No	2	No
	Blue Oaks Blvd	1	No	2	No
	Sunset Blvd Eastbound	2	Yes	2	Yes
	Sunset Blvd Westbound	2	Yes	2	Yes
	Whitney Ranch Pkwy Eastbound ²	n/a		2	Yes
	Whitney Ranch Pkwy Westbound ³	n/a		2	Yes
	Twelve Bridges Dr ⁴	2	No	3	Yes
Southbound	Lincoln Blvd	2	No	3	Yes
	Twelve Bridges Dr	2	No	2	No
	Placer Pkwy Westbound ³	n/a		2	Yes
	Placer Pkwy Eastbound ²	n/a		2	Yes
	Sunset Blvd Westbound	2	Yes	2	No
	Sunset Blvd Eastbound	3	Yes	3	Yes
	Blue Oaks Blvd Westbound	1	No	2	Yes
	Blue Oaks Blvd Eastbound	2	Yes	3	Yes
	Pleasant Grove Blvd Westbound	2	Yes	2	Yes
	Pleasant Grove Blvd Eastbound	2	No	3	Yes
	Galleria Blvd ⁵	1	No	3	Yes

Notes: Shading indicates a change from the existing configuration.

- To be constructed under the Stanford Ranch Road/SR 65 NB Ramps project
- To be constructed under the Placer Parkway project
- To be constructed under the SR 65/Whitney Ranch Parkway Interchange project
- To be constructed under the SR 65/Twelve Bridges Drive Interchange project
- To be constructed under the I-80/SR 65 Interchange Phase 1 project

Source: Fehr & Peers, 2015

Ramp meter installation will be provided under separate projects for the Stanford Ranch Road/Galleria Boulevard, Whitney Ranch Parkway/Placer Parkway, and Twelve Bridges Drive interchanges. In the northbound direction, the Blue Oaks Boulevard on-ramp would be widened to provide an additional lane for storage. In the southbound direction, widening for an HOV preferential lane would also be provided at Lincoln Boulevard, Blue Oaks Boulevard westbound, and Pleasant Grove Boulevard eastbound on-ramps. At the Sunset Boulevard westbound on-ramp, design year demand volume would increase such that a second lane of storage would be needed to prevent ramp meter queues from extending onto the local street. As a result, the existing HOV preferential lane would be converted to a general purpose lane. Widening for a third lane to maintain the HOV preferential lane is not feasible due to the geometry of the loop ramp. At the Blue Oaks Boulevard eastbound on-ramp, the ramp would be widened to provide a second general purpose lane for storage.

5.2. Construction Year Conditions

Overall network performance statistics for AM and PM peak period operations are summarized for each alternative in Tables 23 and 24 below, respectively.

TABLE 23: COMPARISON OF OVERALL NETWORK PERFORMANCE – CONSTRUCTION YEAR AM PEAK PERIOD					
Performance Measure		Existing Conditions	Construction Year Conditions		
			Alternative 1	Alternative 2	Alternative 3
Volume Served (% of total demand)		143,450 (100%)	167,490 (99%)	167,510 (99%)	168,620 (99%)
Vehicle Miles of Travel (VMT)		645,270	799,520	797,360	788,490
Person Miles of Travel		786,260	982,670	979,180	965,810
Vehicle Hours of Travel (VHT)		13,760	18,060	18,000	18,270
Vehicle Hours of Delay (VHD) (% of VHT)		2,670 (19%)	4,350 (24%)	4,330 (24%)	4,730 (26%)
Average Delay per Vehicle (min)		1.12	1.56	1.55	1.68
Person Hours of Delay		3,240	5,160	5,140	5,600
Average Speed		46.9	44.3	44.3	43.2
Average Speed for HOVs		47.0	46.7	46.6	45.7
Travel Time: Ferrari Ranch Rd to I-80	SOV	-	8:09	8:09	8:47
	HOV	-	8:04	8:08	8:46
Travel Time: Blue Oaks Blvd to Antelope Rd	SOV	9:44	8:51	8:50	9:16
	HOV	9:27	8:33	8:33	8:54
Notes: PMT = person miles of travel, PHD = person hours of delay					
Source: Fehr & Peers, 2015					

The results presented in Tables 23 and 24 are summarized below.

- The build alternatives improve network performance compared to the no build alternative during the AM peak period.
- Also during the AM peak period, Alternative 2 (General Purpose Lane) has the lowest delay and highest average speed. However, all three alternatives have about the same results.
- During the PM peak period, Alternative 2 (General Purpose Lane) has the lowest delay and highest average speed. The worst performing alternative is Alternative 1 (Carpool Lane). The bottleneck at the eastbound I-80 connector ramp to northbound SR 65 operates worst under Alternative 1 although all three alternatives have the same lane configuration at this location.

Performance Measure		Existing Conditions	Construction Year Conditions		
			Alternative 1	Alternative 2	Alternative 3
Volume Served (% of total demand)		198,170 (101%)	231,400 (99%)	232,110 (99%)	233,870 (99%)
Vehicle Miles of Travel (VMT)		730,100	924,670	930,140	909,560
Person Miles of Travel		880,180	1,146,120	1,150,200	1,123,280
Vehicle Hours of Travel (VHT)		16,850	27,210	25,890	25,870
Vehicle Hours of Delay (VHD) (% of VHT)		3,950 (23%)	10,940 (40%)	9,520 (37%)	9,840 (38%)
Average Delay per Vehicle (min)		1.20	2.84	2.46	2.52
Person Hours of Delay		4,670	12,770	11,220	11,520
Average Travel Speed		43.3	34.0	35.9	35.2
Average HOV Speed		44.7	39.1	39.8	39.5
Travel Time: I-80 to Ferrari Ranch Rd	SOV	-	7:56	7:59	7:56
	HOV	-	7:56	7:59	7:55
Travel Time: Auburn Blvd to Blue Oaks Blvd	SOV	9:16	20:03	14:05	17:23
	HOV	9:11	9:23	9:09	9:38

Source: Fehr & Peers, 2015

- The PM peak-hour travel time for northbound SR 65 is about the same for all alternatives. The Auburn Boulevard to Blue Oaks Boulevard travel time is lowest for Alternative 2 and highest for Alternative 1.

- The AM peak hour travel times through the I-80/SR 65 Interchange are better than existing conditions for all alternatives due to the separate I-80/SR 65 Interchange Improvements Phase 1 project.

Specific details about construction year freeway and arterial intersection operations are discussed in more detail in the following sections.

5.2.1. Freeway Operations

Detailed freeway operations analysis was completed for the peak hour (7:30 to 8:30 AM and 4:30 to 5:30 PM) of the four hour AM and PM peak periods. The AM and PM peak-hour served volume as percentage of the demand volume are listed in Figure 41. The AM and PM peak hour results for selected locations are reported in Tables 25 and 26, respectively. The remaining results are available in the Technical Appendix. Figures 42 through 48 display the average speed in the mixed-flow lanes throughout the network during the peak periods for each alternative.

Northbound SR 65

During the AM and PM peak hours, all alternatives would have a bottleneck on the loop ramp connector from eastbound I-80. Alternative 3 (No Build) would have LOS E conditions at Pleasant Grove Boulevard in both peak hours, but the build alternatives would have LOS E only during the PM peak hour due to the additional lane.

The proposed project would have an impact at the loop ramp connector from eastbound I-80 to northbound SR 65. The impact would occur during the AM peak hour for Alternative 1 (Carpool Lane) and during both peak hours for Alternative 2 (General Purpose Lane). This impact could be mitigated by constructing the ultimate phase of the planned I-80/SR 65 Interchange Improvement project that will realign and widen the connector to three lanes.

Southbound SR 65

During the AM peak hour, the build alternatives would have LOS F conditions at the Sunset Boulevard westbound on-ramp. The congestion would last for about 45 minutes. The lower demand volume for the no build alternative would result in acceptable LOS D conditions.

Alternative 3 would have LOS F operations downstream between Sunset Boulevard and Pleasant Grove Boulevard. The congestion would last for about an hour. The widening under Alternatives 1 and 2 would improve conditions to LOS D or better at the Pleasant Grove Boulevard bottleneck. However, Alternative 1 would have LOS F at the Galleria Boulevard on-ramp. Despite the LOS F conditions at Galleria Boulevard, the congestion would be localized and last for only about 15 minutes.

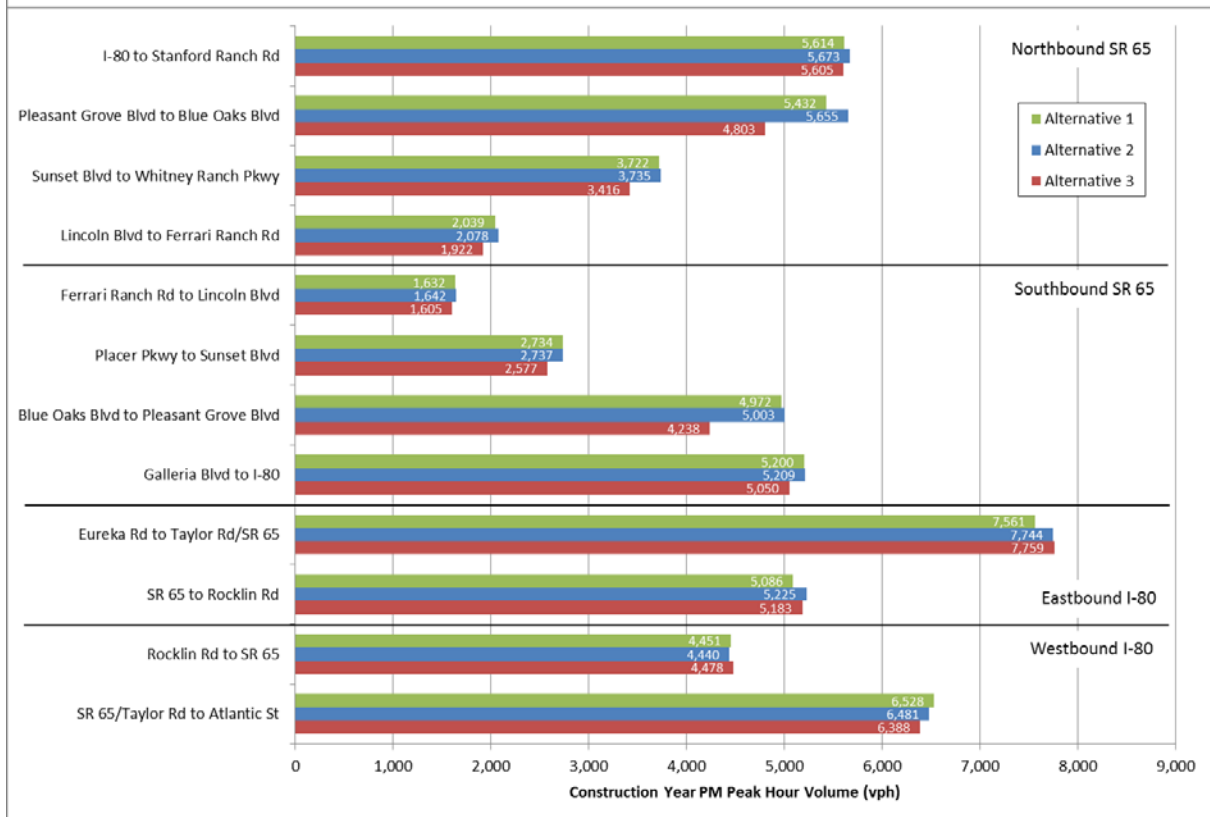
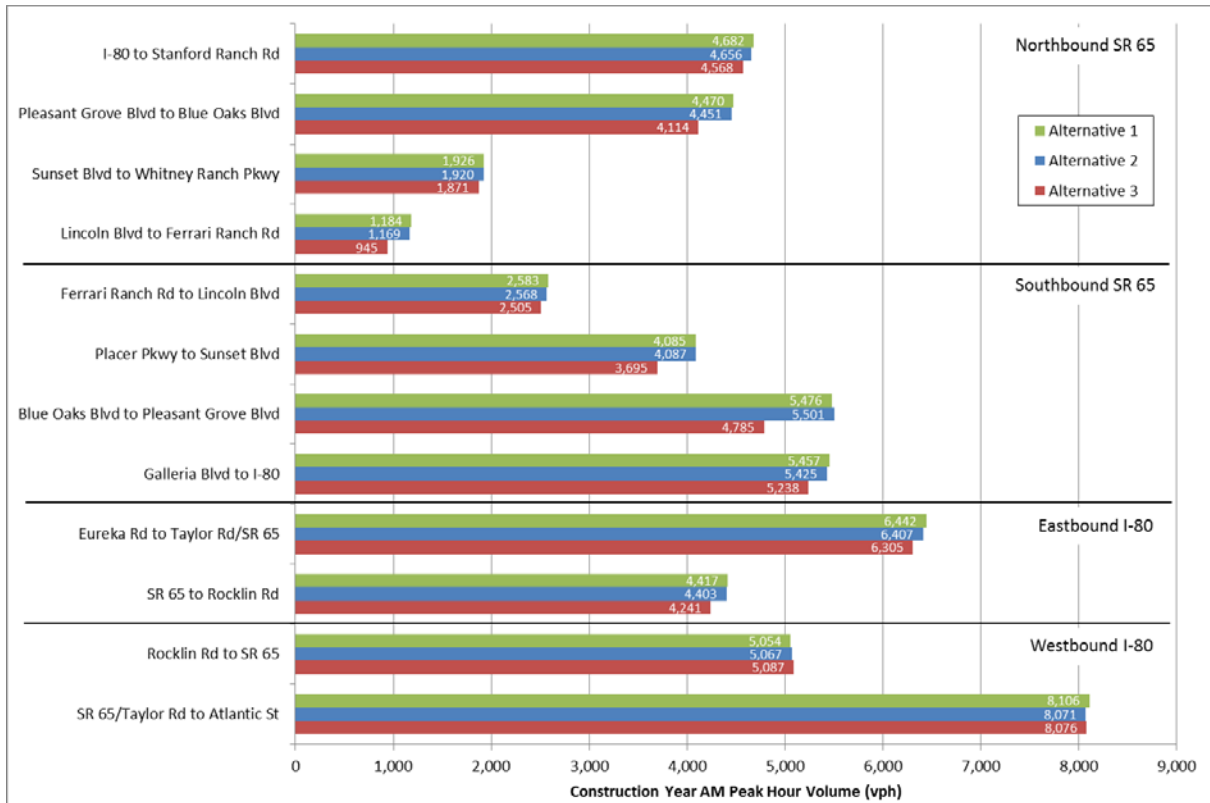
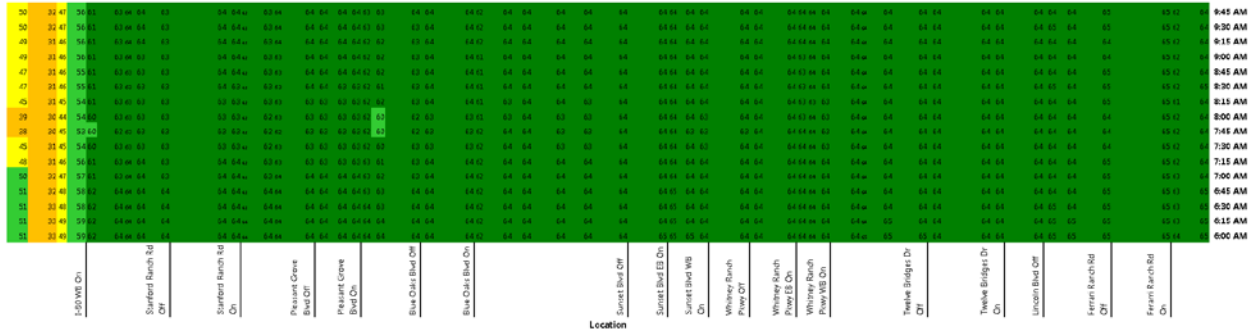

Figure 40 – Freeway Served Volume for Construction Year Conditions

TABLE 25: SELECTED FREEWAY OPERATIONS RESULTS – CONSTRUCTION YEAR AM PEAK HOUR CONDITIONS					
Freeway	Location	Type¹	Alternative 1	Alternative 2	Alternative 3
NB SR 65	I-80 Eastbound Connector Ramp	Basic	<u>F / 45</u>	<u>F / 47</u>	E / 44
	Stanford Ranch Rd to Pleasant Grove Blvd	Weave	C / 24	C / 24	D / 31
					E / 36
	Pleasant Grove Blvd On-ramp	Merge	D / 33	D / 33	C / 27
	Blue Oaks Blvd Off-ramp	Diverge	C / 27	C / 27	
	Blue Oaks Blvd to Sunset Blvd	Basic	C / 19	C / 19	C / 25
Whitney Ranch Pkwy to Twelve Bridges Dr	Weave	B / 13	B / 13	B / 16	
				B / 17	
SB SR 65	Twelve Bridges Dr to Placer Pkwy	Weave	C / 28	D / 28	D / 33
					D / 31
	Sunset Blvd WB On-ramp	Merge	<u>F / 68</u>	<u>F / 75</u>	D / 29
	Blue Oaks Blvd WB On-ramp	Merge	D / 30	C / 24	<u>F / 56</u>
	Pleasant Grove Blvd to Galleria Blvd	Basic	D / 29	C / 27	D / 31
	Galleria Blvd On-ramp	Merge	<u>F / 54</u>	E / 42	E / 39
I-80 Westbound Connector Ramp	Basic	E / 41	E / 40	E / 38	
EB I-80	Auburn Blvd to Douglas Blvd	Basic	D / 34	E / 35	E / 39
	Eureka Rd Off-ramp	Diverge	D / 30	D / 30	D / 29
	SR 65 Off-ramp	Diverge	D / 33	D / 32	D / 31
	SR 65 to Rocklin Rd	Basic	C / 22	C / 22	C / 21
WB I-80	Rocklin Rd to Carpool Lane Start	Basic	D / 29	D / 28	D / 29
	Atlantic St On-ramp	Merge	E / 37	E / 37	E / 38
	Douglas Blvd Off-ramp	Diverge	D / 33	D / 33	D / 33
	Douglas Blvd EB On-ramp	Merge	E / 35	E / 37	E / 39
	Riverside Ave Off-ramp	Diverge	D / 34	D / 33	D / 33
	Antelope Rd Off-ramp	Diverge	<u>F / 53</u>	<u>F / 53</u>	<u>F / 61</u>
	Truck Scales On-ramp	Merge	<u>F / 92</u>	<u>F / 94</u>	<u>F / 95</u>
	Elkhorn Blvd EB On-ramp	Merge	<u>F / 77</u>	<u>F / 77</u>	<u>F / 77</u>
Notes:	Bold and underline font indicate LOS F conditions. Shaded cells indicate a project impact. The level of service and average density for the study segment are reported.				
	¹ The facility type reported is for Alternative 1. The other results are contained in the Technical Appendix.				
Source:	Fehr & Peers, 2015				

TABLE 26: SELECTED FREEWAY OPERATIONS RESULTS – CONSTRUCTION YEAR PM PEAK HOUR CONDITIONS					
Freeway	Location	Type¹	Alternative 1	Alternative 2	Alternative 3
NB SR 65	I-80 Eastbound Connector Ramp	Basic	<u>F / 61</u>	<u>F / 63</u>	<u>F / 61</u>
	Stanford Ranch Rd to Pleasant Grove Blvd	Weave	C / 26	C / 26	D / 32 E / 36
	Pleasant Grove Blvd On-ramp	Merge	E / 39	E / 40	D / 29
	Blue Oaks Blvd Off-ramp	Diverge	D / 32	D / 32	
	Blue Oaks Blvd to Sunset Blvd	Basic	D / 26	D / 27	D / 29
	Whitney Ranch Pkwy to Twelve Bridges Dr	Weave	C / 23	C / 23	D / 29 D / 30
SB SR 65	Twelve Bridges Dr to Placer Pkwy	Weave	B / 16	B / 16	B / 19 B / 19
	Sunset Blvd WB On-ramp	Merge	C / 25	C / 25	C / 21
	Blue Oaks Blvd WB On-ramp	Merge	C / 26	C / 21	C / 26
	Pleasant Grove Blvd to Galleria Blvd	Basic	C / 25	C / 24	D / 27
	Galleria Blvd On-ramp	Merge	D / 34	D / 33	D / 33
	I-80 Westbound Connector Ramp	Basic	D / 32	D / 32	D / 32
EB I-80	Auburn Blvd to Douglas Blvd	Basic	<u>F / 108</u>	D / 34	<u>F / 81</u>
	Eureka Rd Off-ramp	Diverge	<u>F / 118</u>	<u>F / 110</u>	<u>F / 106</u>
	SR 65 Off-ramp	Diverge	<u>F / 91</u>	<u>F / 95</u>	<u>F / 92</u>
	SR 65 to Rocklin Rd	Basic	C / 22	C / 23	C / 23
WB I-80	Rocklin Rd to Carpool Lane Start	Basic	C / 24	C / 24	C / 24
	Atlantic St On-ramp	Merge	D / 30	D / 30	D / 30
	Douglas Blvd Off-ramp	Diverge	C / 27	C / 28	C / 27
	Douglas Blvd EB On-ramp	Merge	D / 33	D / 30	D / 31
	Riverside Ave Off-ramp	Diverge	D / 31	D / 31	D / 31
	Antelope Rd Off-ramp	Diverge	D / 29	D / 29	D / 29
	Truck Scales On-ramp	Merge	C / 26	C / 26	C / 27
	Elkhorn Blvd EB On-ramp	Merge	D / 28	D / 28	D / 28
Notes: Bold and underline font indicate LOS F conditions. Shaded cells indicate a project impact. The level of service and average density for the study segment are reported.					
¹ The facility type reported is for Alternative 1. The other results are contained in the Technical Appendix.					
Source: Fehr & Peers, 2015					

CARPOOL LANE (ALTERNATIVE 1)



GENERAL PURPOSE LANE (ALTERNATIVE 2)

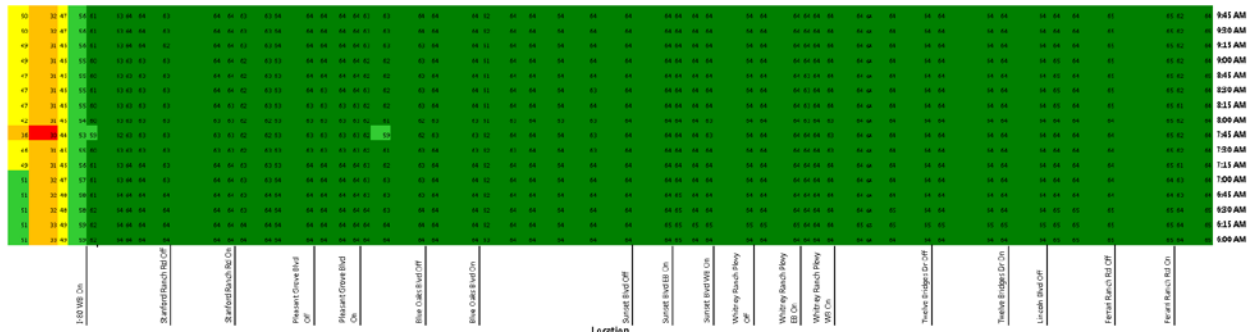

NO BUILD (ALTERNATIVE 3)

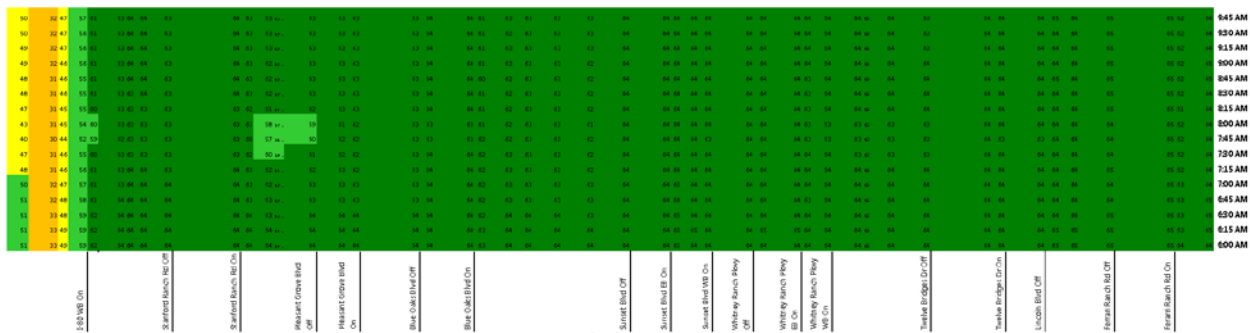
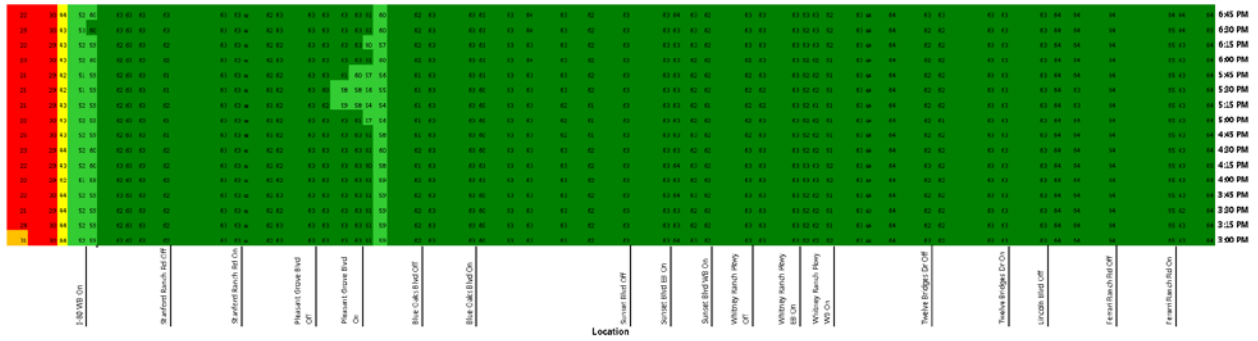
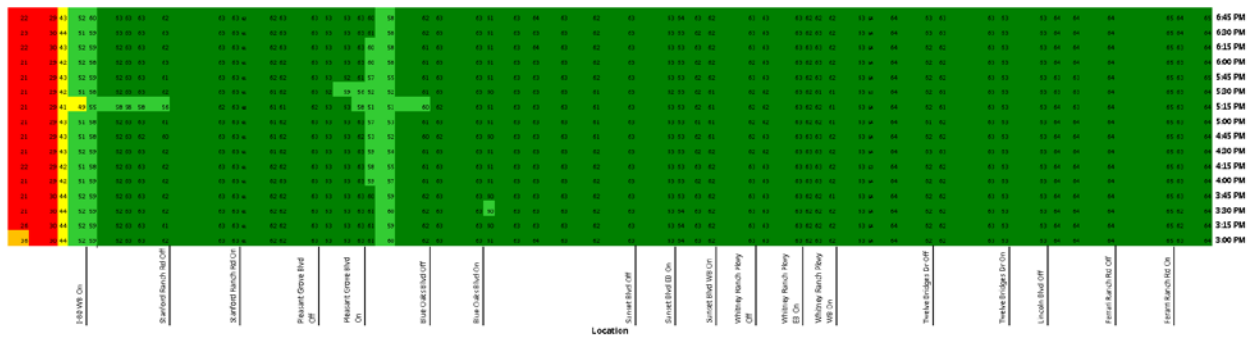

Figure 41 – Northbound SR 65 Construction Year AM Peak Period Speed Contour Map

CARPOOL LANE (ALTERNATIVE 1)



GENERAL PURPOSE LANE (ALTERNATIVE 2)



NO BUILD (ALTERNATIVE 3)

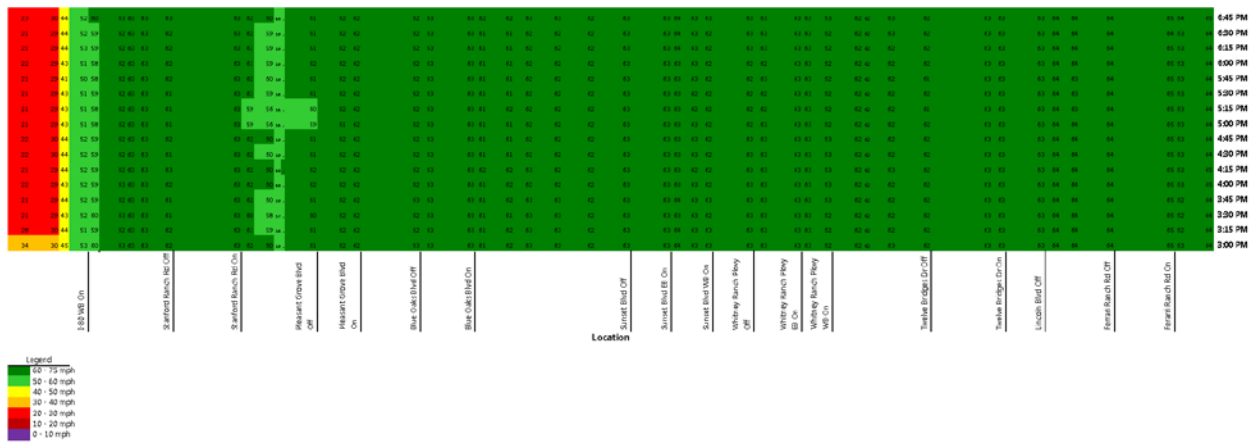
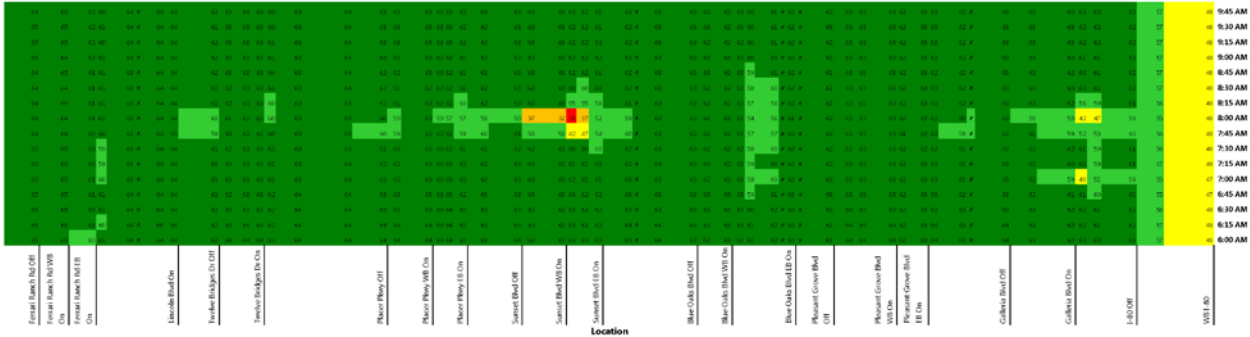
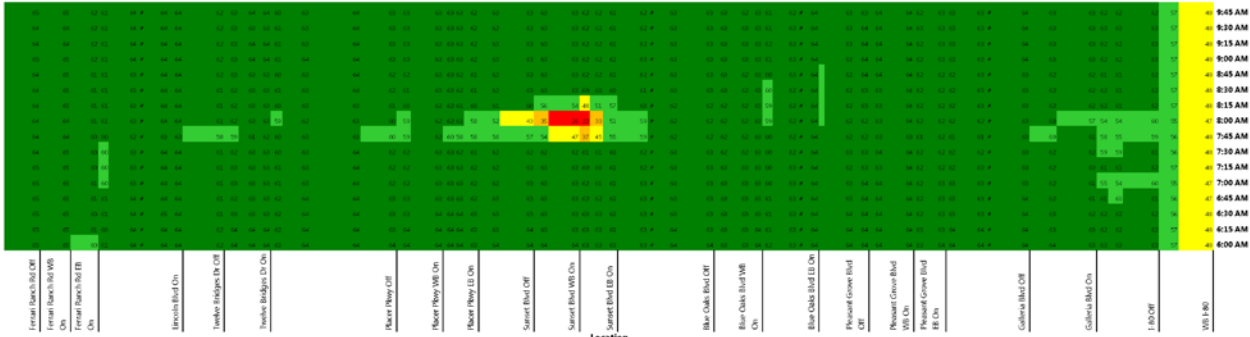

Figure 42 – Northbound SR 65 Construction Year PM Peak Period Speed Contour Map

CARPOOL LANE (ALTERNATIVE 1)



GENERAL PURPOSE LANE (ALTERNATIVE 2)



NO BUILD (ALTERNATIVE 3)

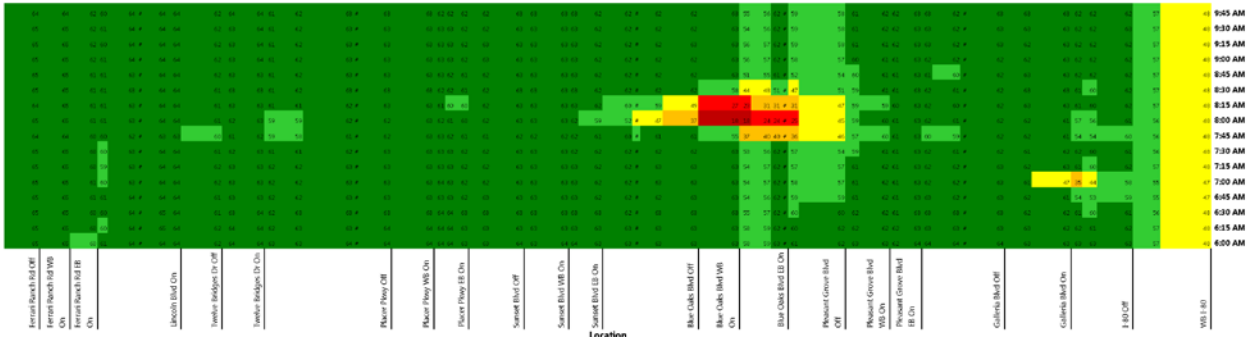
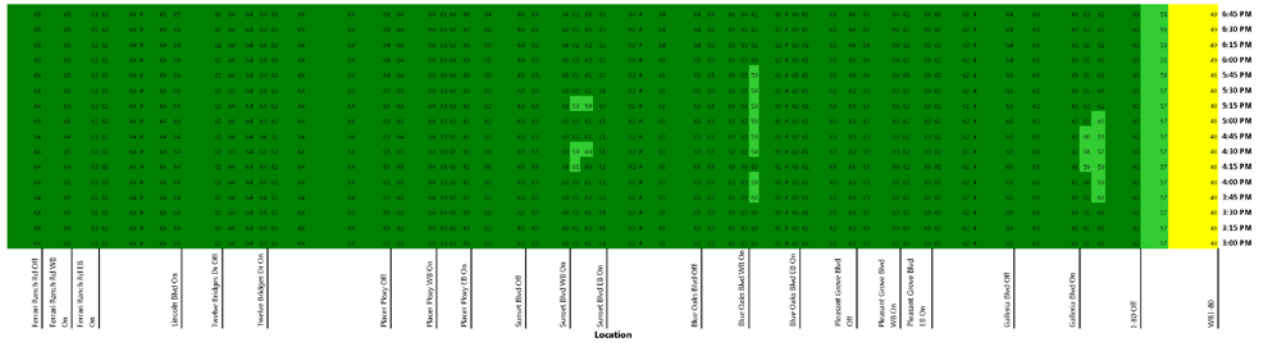
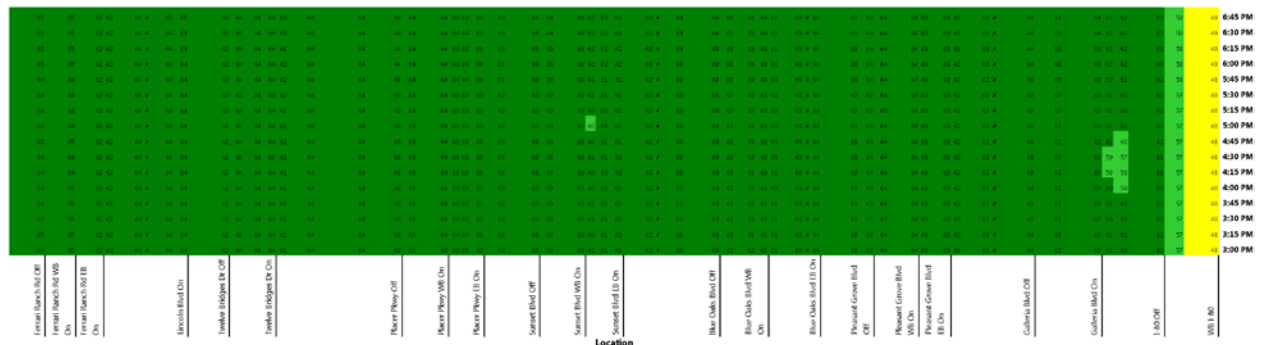

Figure 43 – Southbound SR 65 Construction Year AM Peak Period Speed Contour Map

CARPOOL LANE (ALTERNATIVE 1)



GENERAL PURPOSE LANE (ALTERNATIVE 2)



NO BUILD (ALTERNATIVE 3)

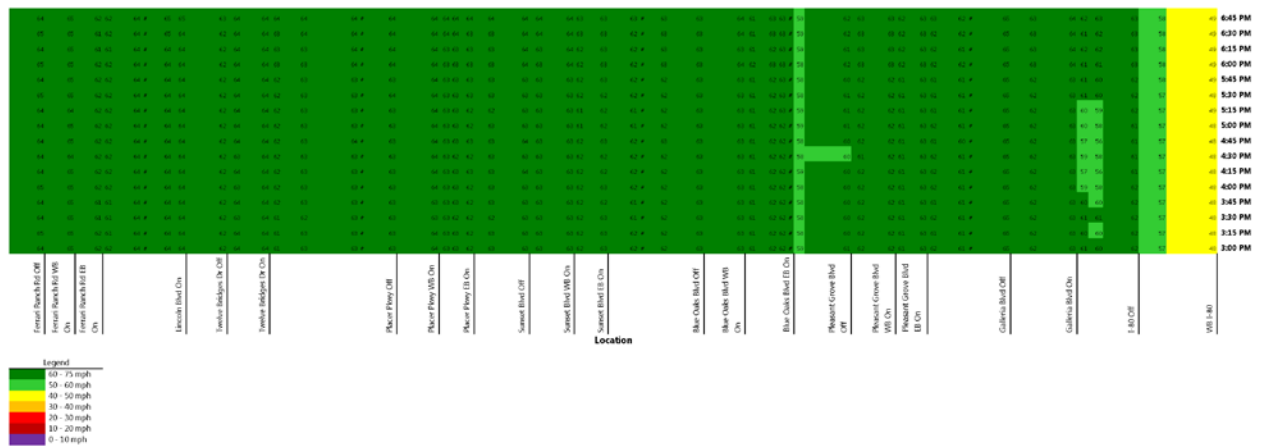
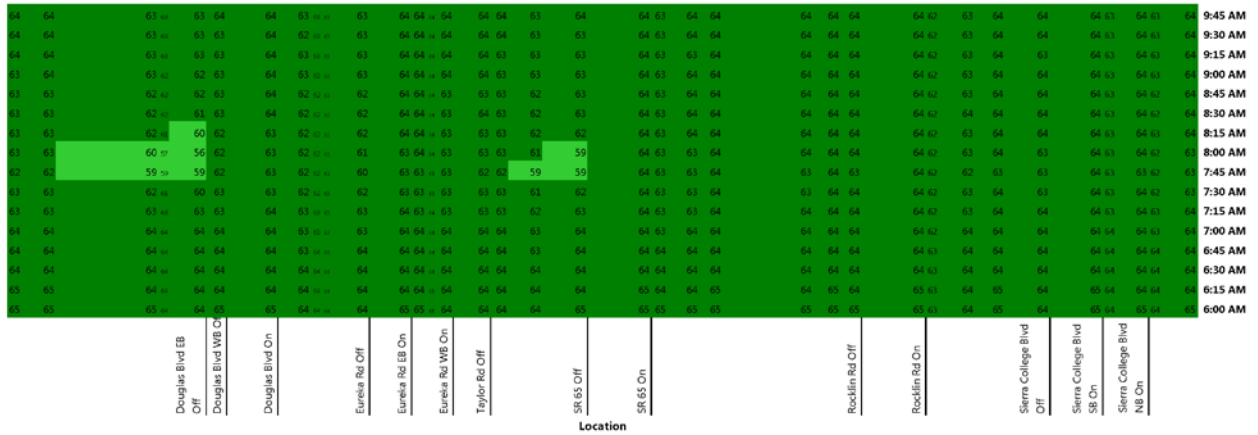
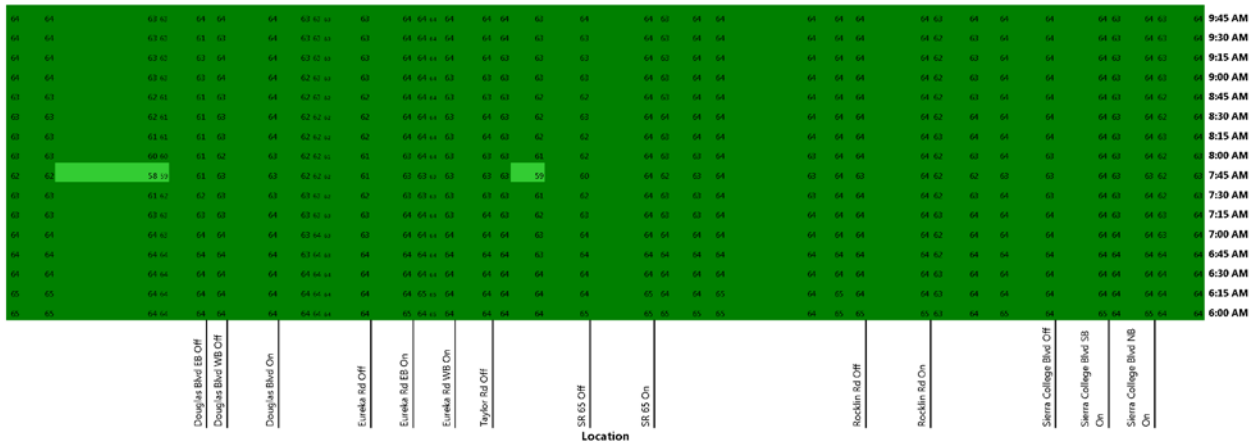

Figure 44 – Southbound SR 65 Construction Year PM Peak Period Speed Contour Map

CARPOOL LANE (ALTERNATIVE 1)



GENERAL PURPOSE LANE (ALTERNATIVE 2)



NO BUILD (ALTERNATIVE 3)

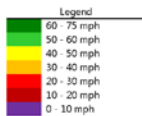
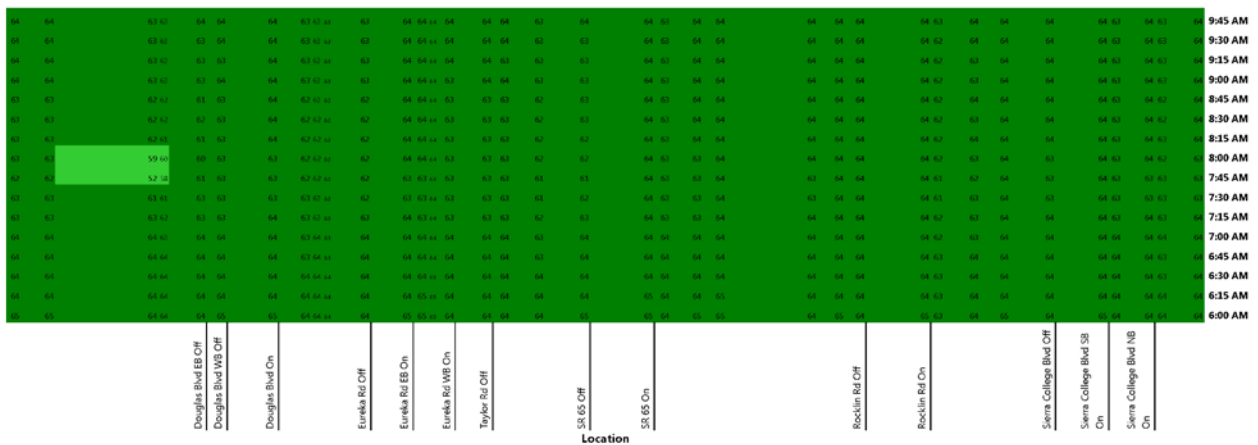
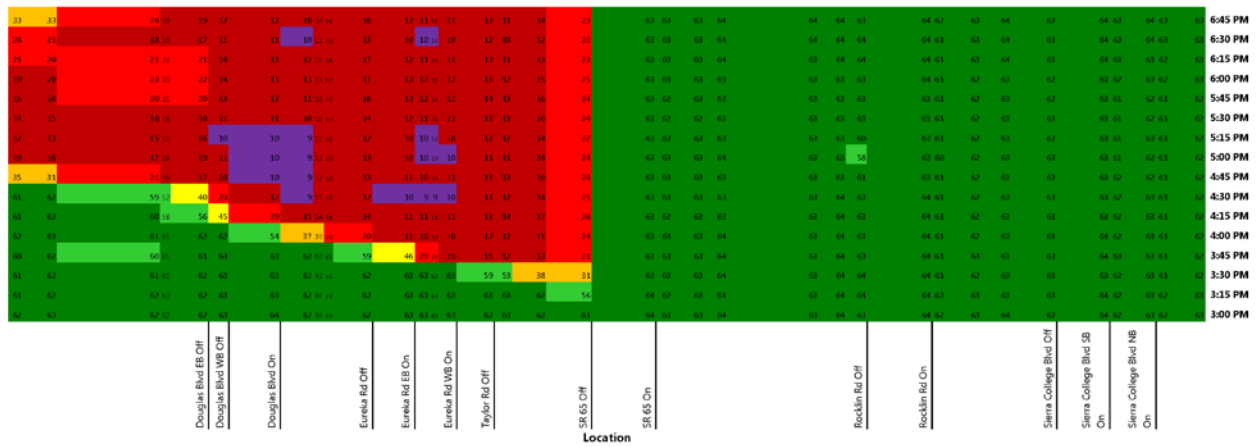
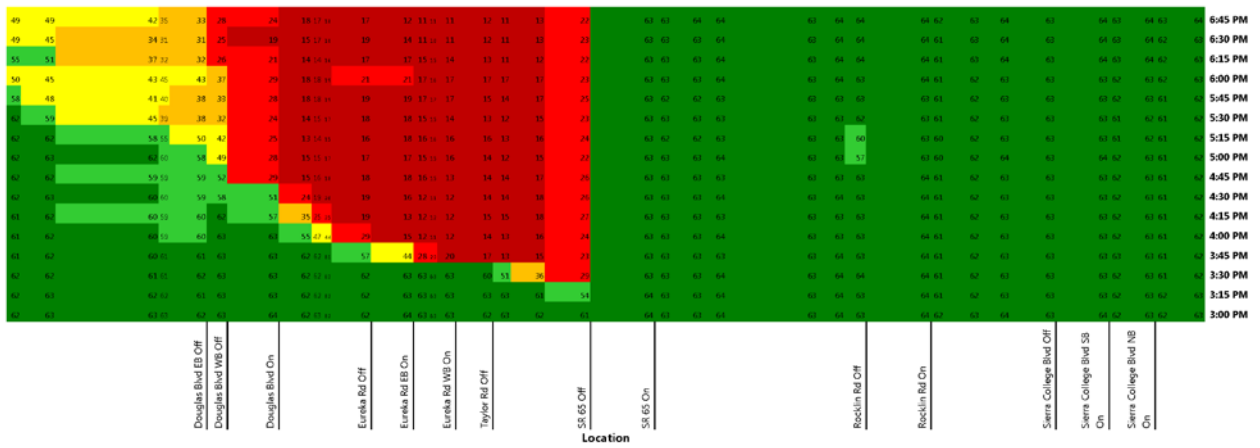

Figure 45 – Eastbound I-80 Construction Year AM Peak Period Speed Contour Map

CARPOOL LANE (ALTERNATIVE 1)



GENERAL PURPOSE LANE (ALTERNATIVE 2)



NO BUILD (ALTERNATIVE 3)

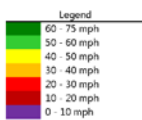
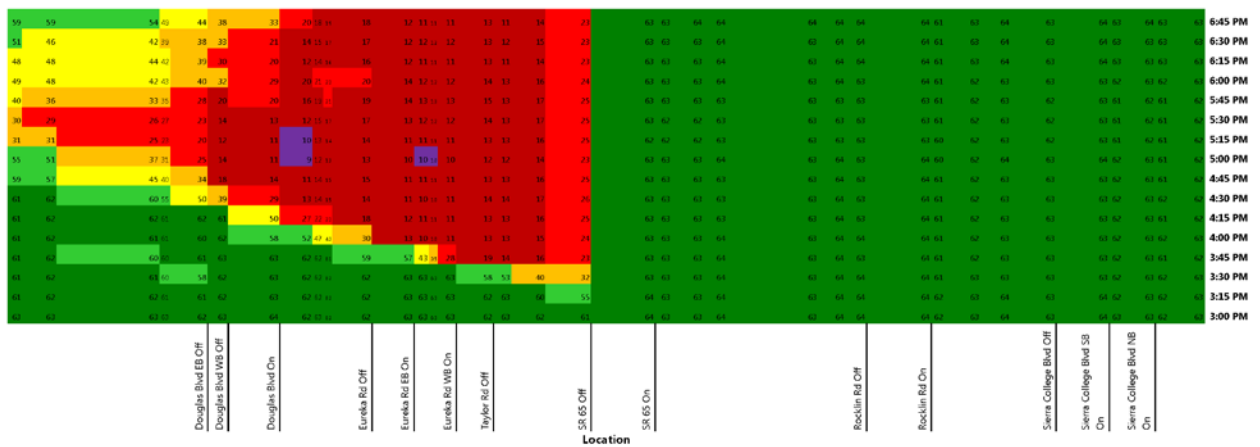
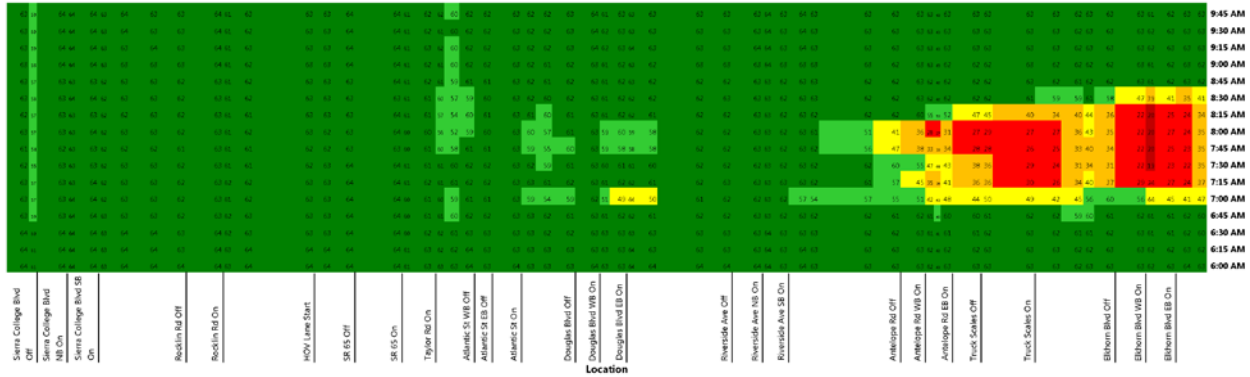
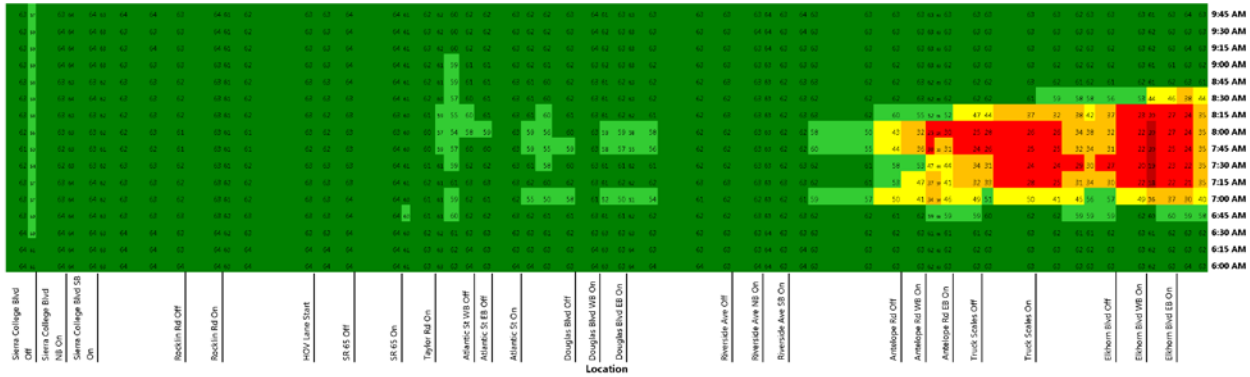

Figure 46 – Eastbound I-80 Construction Year PM Peak Period Speed Contour Map

CARPOOL LANE (ALTERNATIVE 1)



GENERAL PURPOSE LANE (ALTERNATIVE 2)



NO BUILD (ALTERNATIVE 3)

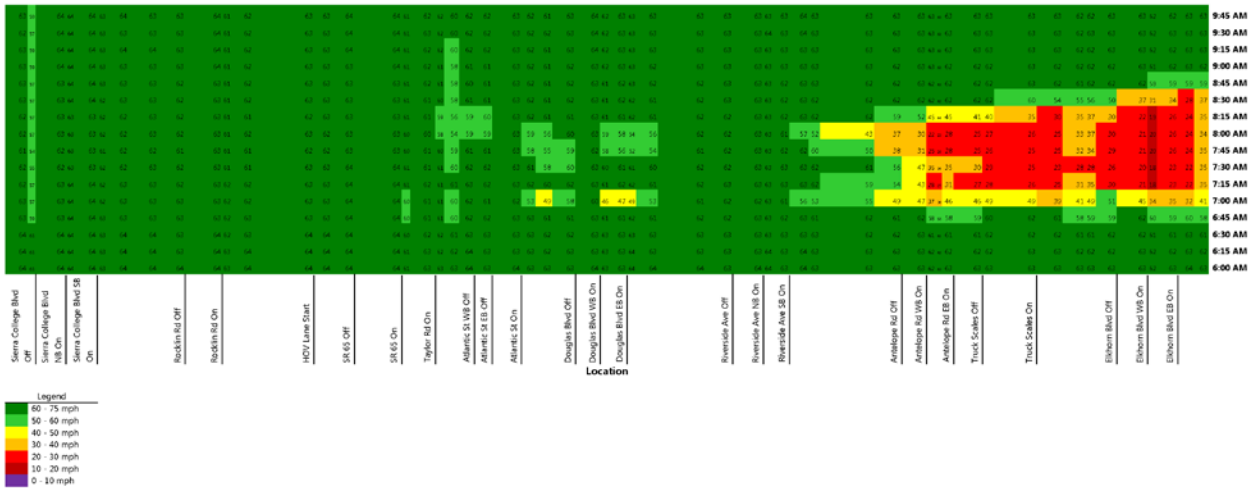
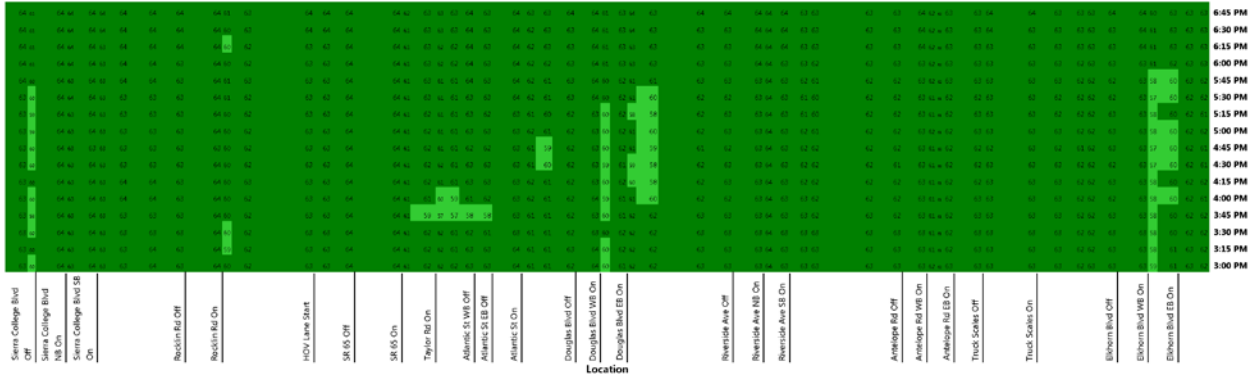
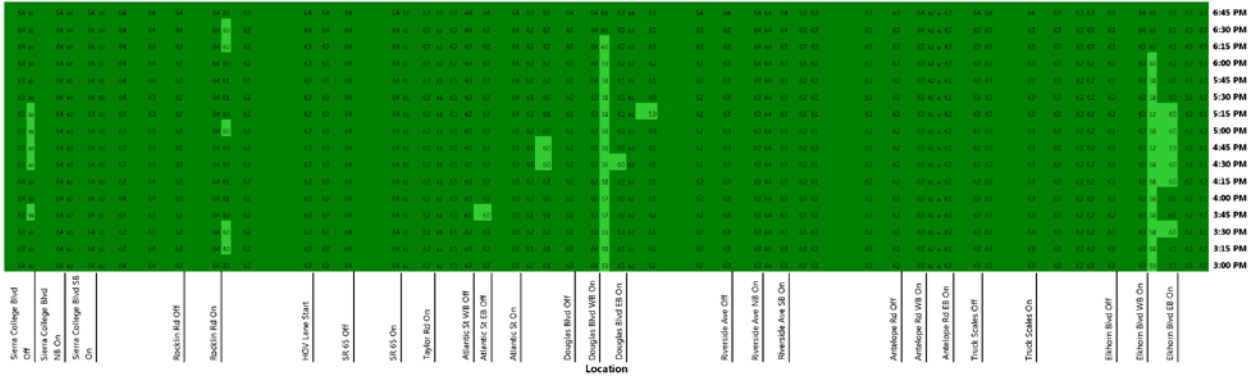

Figure 47 – Westbound I-80 Construction Year AM Peak Period Speed Contour Map

CARPOOL LANE (ALTERNATIVE 1)



GENERAL PURPOSE LANE (ALTERNATIVE 2)



NO BUILD (ALTERNATIVE 3)

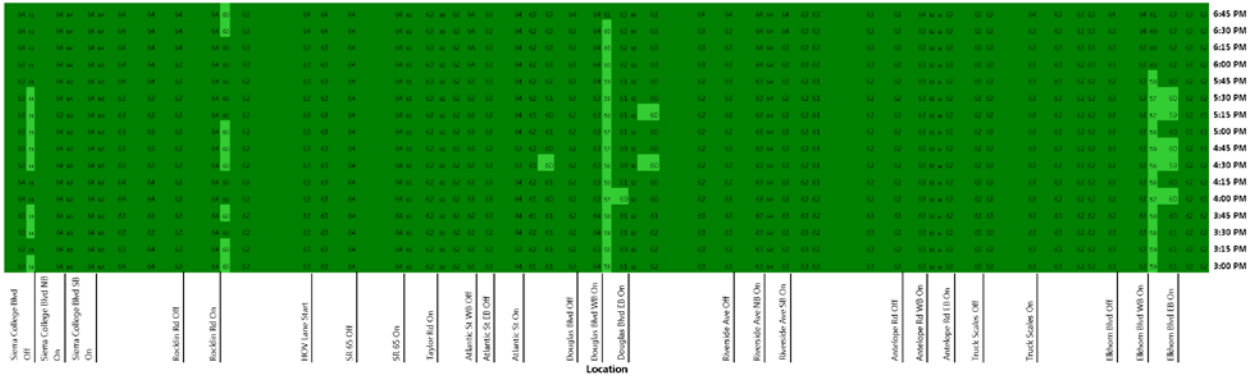

Figure 48 – Westbound I-80 Construction Year PM Peak Period Speed Contour Map

All three alternatives would operate with LOS D or better conditions during the PM peak hour. The planned I-80/SR 65 Interchange Improvements Phase 1 project would eliminate the existing bottleneck during the PM peak hour.

During the AM peak hour, the proposed project (Alternatives 1 and 2) would have an impact at the Sunset Boulevard off-ramp to on-ramp segment and at the Sunset Boulevard westbound on-ramp. This impact could be mitigated by extending the planned auxiliary lane that starts at the eastbound on-ramp upstream to start and the westbound on-ramp. Alternately, more restrictive metering could be used at the upstream on-ramps. More restrictive metering for ramps at Sunset Boulevard, Placer Parkway, and Twelve Bridges Drive could cause queuing that would extend onto the local street network.

Additionally, the proposed project (Alternative 1) would have an impact at the Galleria Boulevard on-ramp during the AM peak hour. This impact could be mitigated by constructing the ultimate phase of the planned I-80/SR 65 Interchange Improvement project that will widen the freeway at this location by two lanes (a carpool lane and an acceleration lane). Alternately, more restrictive metering could be used at the upstream on-ramps. More restrictive metering for ramps at Galleria Boulevard, Pleasant Grove Boulevard, and Blue Oaks Boulevard could cause queuing that would extend onto the local street network.

Eastbound I-80

For all alternatives, the freeway operations results indicate that eastbound I-80 would have LOS D or better conditions during the AM peak hour. However, the freeway would have a bottleneck at the SR 65 off-ramp during the PM peak period. The PM peak period congestion would last for more than three and a half hours and extend upstream past Auburn Boulevard.

Although the total demand volumes are similar across alternatives and the lane configurations are the same, the results for Alternative 1 (Carpool Lane) show much worse congestion during the PM peak hour. One potential reason is that Alternative 1 has higher HOV demand volume, which causes more weaving conflicts at the SR 65 off-ramp than the other alternatives. With these results, Alternative 1 has project impacts during the PM peak hour on eastbound I-80 from Auburn Boulevard to SR 65. Alternative 2 also has project impacts at the Douglas Boulevard on-ramp, the Eureka Road off-ramp, and the SR 65 off-ramp. To mitigate these impacts, the ultimate phase of the I-80/SR 65 Interchange Improvements project should be constructed.

Westbound I-80

During the AM peak period, bottlenecks would exist under all alternatives at Elkhorn Boulevard as shown in Figure 47. Short-term slow speeds would also occur upstream at Douglas Boulevard prior to the peak hour. The downstream bottleneck at Elkhorn Boulevard would last for about two hours and extend upstream to Antelope Road. All three alternatives would have about the same operating conditions in this area. Westbound I-80 would operate with LOS D or better conditions during the PM peak hour.

Although Alternatives 1 and 2 would have LOS F conditions during the AM peak hour, the proposed project would not have impacts because the no build alternative would operate worse.

5.2.2. Arterial Intersection Operations

Tables 27 and 28 show the LOS and average delay at key study intersections under construction year conditions during the AM and PM peak hours, respectively. Tables 29 and 30 show the average maximum queue length at off-ramps under construction year conditions during the AM and PM peak hours. Based on the evaluation criteria for this study, Alternative 1 (Carpool Lane) has six impacts, and Alternative 2 (General Purpose Lane) has eight impacts. See the Appendix for all study intersection results.

Intersection	Threshold	Alternative 1	Alternative 2	Alternative 3
6. Blue Oaks Blvd / Washington Blvd / SR 65 SB Ramps	C	C / 31	C / 35	<u>D / 52</u>
10. Stanford Ranch Rd / Five Star Blvd	C	C / 27	C / 27	C / 29
11. Stanford Ranch Rd / SR 65 NB Ramps	D	B / 15	B / 20	B / 18
12. Galleria Blvd / SR 65 SB Ramps	D	B / 17	B / 17	B / 17
16. Roseville Pkwy / Taylor Rd	D	D / 49	D / 46	<u>F / 133</u>
18. Atlantic St / Wills Rd	C	C / 24	C / 24	B / 19
20. Eureka Rd / Taylor Rd / I-80 EB Ramps	E	C / 25	C / 25	C / 22
21. Eureka Rd / Sunrise Ave	C	C / 32	C / 33	C / 26
23. Douglas Blvd / Harding Blvd	E	D / 51	C / 30	D / 36
24. Douglas Blvd / I-80 WB Ramps	C	C / 23	C / 24	B / 20
25. Douglas Blvd / I-80 EB Ramps	C	B / 20	A / 10	B / 12
26. Douglas Blvd / Sunrise Ave	D	C / 33	C / 33	C / 28
28. Pacific St / Sunset Blvd	C	C / 24	C / 24	C / 27
29. Rocklin Rd / Granite Dr	C	B / 17	B / 18	B / 19
30. Rocklin Rd / I-80 WB Ramps	C	C / 23	C / 29	C / 21
31. Rocklin Rd / I-80 EB Ramps	C	<u>D / 42</u>	<u>D / 49</u>	<u>D / 37</u>
Note: Bold and underline font indicate unacceptable operations. Shaded cells indicate a project impact. The LOS and average delay in seconds per vehicle are reported. Source: Fehr & Peers, 2015				

The following intersections would operate at an unacceptable LOS based on the evaluation criteria under all project alternatives.

- Blue Oaks Boulevard/Washington Boulevard/SR 65 Southbound Ramps (PM only)

- Stanford Ranch Road/Five Star Boulevard (PM only)
- Eureka Road/Sunrise Avenue (PM only)
- Rocklin Road/Granite Drive (PM only)
- Rocklin Road/I-80 Eastbound Ramps (AM only)

The analysis results indicate that these intersections would need capacity enhancements with and without the proposed project to operate within the established LOS thresholds for these locations or peak period travel demand management strategies would need to be employed in the study area. Before any improvements are proposed though, the interaction between these locations and the rest of the network should be considered. In some cases, the operation of these intersections meters traffic accessing the freeway. In other locations, improvements to the freeway system, such as an auxiliary lane, may reduce demand and/or queuing that would improve intersection operations.

TABLE 28: INTERSECTION OPERATIONS RESULTS – CONSTRUCTION YEAR PM PEAK HOUR CONDITIONS				
Intersection	Threshold	Alternative 1	Alternative 2	Alternative 3
6. Blue Oaks Blvd / Washington Blvd / SR 65 SB Ramps	C	<u>D / 47</u>	<u>D / 44</u>	<u>F / 126</u>
10. Stanford Ranch Rd / Five Star Blvd	C	<u>F / 92</u>	<u>E / 76</u>	<u>D / 48</u>
11. Stanford Ranch Rd / SR 65 NB Ramps	D	C / 23	C / 25	B / 12
12. Galleria Blvd / SR 65 SB Ramps	D	B / 16	B / 17	B / 16
16. Roseville Pkwy / Taylor Rd	D	D / 51	D / 53	D / 42
18. Atlantic St / Wills Rd	C	<u>D / 39</u>	<u>D / 36</u>	C / 22
20. Eureka Rd / Taylor Rd / I-80 EB Ramps	E	D / 52	E / 72	D / 41
21. Eureka Rd / Sunrise Ave	C	<u>D / 44</u>	<u>D / 44</u>	<u>E / 62</u>
23. Douglas Blvd / Harding Blvd	E	E / 77	<u>F / 128</u>	<u>F / 92</u>
24. Douglas Blvd / I-80 WB Ramps	C	C / 35	C / 31	C / 31
25. Douglas Blvd / I-80 EB Ramps	C	<u>D / 41</u>	<u>D / 35</u>	C / 29
26. Douglas Blvd / Sunrise Ave	D	D / 54	<u>F / 86</u>	D / 39
28. Pacific St / Sunset Blvd	C	C / 30	C / 29	<u>F / 86</u>
29. Rocklin Rd / Granite Dr	C	<u>F / 130</u>	<u>F / 130</u>	<u>F / 127</u>
30. Rocklin Rd / I-80 WB Ramps	C	C / 27	C / 25	<u>D / 38</u>
31. Rocklin Rd / I-80 EB Ramps	C	<u>E / 57</u>	<u>D / 46</u>	C / 33
Note:	Bold and underline font indicate unacceptable operations. Shaded cells indicate a project impact. The LOS and average delay in seconds per vehicle are reported.			
Source:	Fehr & Peers, 2015			

Off-ramp	Storage	Alternative 1	Alternative 2
Eastbound I-80 at Eureka Rd	1,700	500	400
Eastbound I-80 at Rocklin Rd	1,080	300	350
Northbound SR 65 at Northbound Stanford Ranch Rd	1,170	125	100
Northbound SR 65 at Southbound Stanford Ranch Rd	1,800	25	25
Northbound SR 65 at Pleasant Grove Blvd	1,170	150	150
Northbound SR 65 at Blue Oaks Blvd	1,100	600	650
Northbound SR 65 at Sunset Blvd	1,400	275	275
Southbound at Blue Oaks Blvd	2,260	350	350
Southbound at Pleasant Grove Blvd	1,130	175	150
Southbound SR 65 at Southbound Galleria Blvd	1,130	275	275
Southbound SR 65 at Northbound Galleria Blvd	1,780	50	50
Note: Bold and underline font indicate queues that exceed the ramp length. Shaded cells indicate a project impact. The reported value is the average maximum peak-hour queue length in feet.			
Source: Fehr & Peers, 2015			

Off-ramp	Storage	Alternative 1	Alternative 2
Eastbound I-80 at Eureka Rd	1,700	1,125	1,675
Eastbound I-80 at Rocklin Rd	1,080	925	700
Northbound SR 65 at Northbound Stanford Ranch Rd	1,170	350	400
Northbound SR 65 at Southbound Stanford Ranch Rd	1,800	25	50
Northbound SR 65 at Pleasant Grove Blvd	1,170	200	250
Northbound SR 65 at Blue Oaks Blvd	1,100	525	925
Northbound SR 65 at Sunset Blvd	1,400	200	225
Southbound at Blue Oaks Blvd	2,260	250	250
Southbound at Pleasant Grove Blvd	1,130	150	125
Southbound SR 65 at Southbound Galleria Blvd	1,130	250	275
Southbound SR 65 at Northbound Galleria Blvd	1,780	150	175
Note: Bold and underline font indicate queues that exceed the ramp length. Shaded cells indicate a project impact. The reported value is the average maximum peak-hour queue length in feet.			
Source: Fehr & Peers, 2015			

During the AM peak hour, one intersection would have deficient operations under the build alternatives. Rocklin Road/I-80 Eastbound Ramps would operate at LOS D conditions. Alternative 3 (No Build) would also have LOS D conditions at the intersection, but the delay under the build alternatives would be higher due to a higher demand volume. As a result, the deficiency is also an impact.

During the PM peak hour, the proposed project would have impacts at the following study intersections.

- Stanford Ranch Road/Five Star Boulevard
- Atlantic Street/Wills Road
- Douglas Boulevard/Harding Boulevard (Alternative 2 only)
- Douglas Boulevard/I-80 Eastbound Ramps
- Douglas Boulevard/Sunrise Avenue (Alternative 2 only)
- Rocklin Road/Granite Drive
- Rocklin Road/Aguilar Road

The impact at the Stanford Ranch Road intersection is caused by changes in demand volumes. With the additional northbound freeway capacity, more westbound Five Star Boulevard traffic turns left towards the freeway rather than right towards Sunset Boulevard, a parallel route. The impacts may be mitigated by adjusting signal timing. If further improvements are needed, allowing right turns from the middle lane on eastbound Five Star Boulevard may reduce intersection delay without affecting pedestrian safety since no conflicting crosswalk exists for this movement.

Signal timing adjustments are a potential mitigation for the Atlantic Street intersection. The build alternatives have a longer cycle length for the Atlantic Street/Eureka Road corridor compared with the no build alternative. The longer cycle length helps to serve different volumes at the eastbound I-80 off-ramp although the volumes at Wills Road are about the same among the alternatives. This intersection operates acceptably at LOS C under all alternatives under design year conditions, so the operations should be okay under construction year conditions.

The impacts at the Douglas Boulevard intersections could be caused by differences in intersection signal timing. The build alternatives have a shorter cycle length than the no build alternative. Although the shorter cycle length can be more efficient, the offsets are more important to prevent queues between the closely-spaced intersections. So, potential mitigation would include changes to the signal operation or widening of the intersections to provide additional turn lanes.

The impacts at the Rocklin Road intersections would be caused by the higher demand volumes under the build alternatives. The impacts can be mitigated by the planned improvements to the I-80 interchange.

During the peak hours, the average maximum queue lengths for freeway off-ramps at all study intersections are less than the ramp storage length under both build alternatives. However, the high PM peak hour demand volume at the eastbound I-80 off-ramp to Eureka Road would produce long queues that would use up most of the off-ramp storage. The off-ramp queue can be managed through signal timing adjustments although this will worsen delay for the local street approaches. A long-term mitigation is to construct the ultimate I-80/SR 65 Interchange Improvements.

Chapter 6. Summary and Conclusions

6.1. Deficiencies

The study locations that do not meet the LOS threshold are summarized below by alternative. The LOS thresholds are provided in Section 2.5.

Existing Conditions

- AM Peak Hour
 - Westbound I-80: from the westbound Antelope Road on-ramp to the Elkhorn Boulevard off-ramp
 - Northbound SR 65: westbound I-80 on-ramp
 - Southbound SR 65: from the westbound Blue Oaks Boulevard on-ramp to the eastbound Pleasant Grove Boulevard on-ramp
 - Intersections: Blue Oaks Boulevard/Washington Boulevard/SR 65 Southbound Ramps
- PM Peak Hour
 - Eastbound I-80: Eureka Road off-ramp and SR 65 off-ramp
 - Westbound I-80: SR 65 off-ramp
 - Northbound SR 65: from the westbound I-80 on-ramp to the Stanford Ranch Road off-ramp
 - Intersections: Eureka Road/Taylor Road/I-80 Westbound Ramps

Alternative 1 (Carpool Lane)

- Design Year AM Peak Hour
 - Westbound I-80: from the Antelope Road westbound on-ramp to the Elkhorn Boulevard eastbound on-ramp
 - Intersections: Blue Oaks Boulevard/Washington Boulevard/SR 65 Southbound Ramps, Roseville Parkway/Taylor Road, and Eureka Road/Sunrise Avenue
- Design Year PM Peak Hour
 - Intersections: Blue Oaks Boulevard/Washington Boulevard/SR 65 Southbound Ramps, Blue Oaks Boulevard/SR 65 Northbound Ramps, Stanford Ranch Road/Five Star Boulevard, Galleria Boulevard/Roseville Parkway, Roseville Parkway/Creekside Ridge Drive, Eureka Road/Sunrise Avenue, Douglas Boulevard/Harding Boulevard, Douglas

Boulevard/Sunrise Avenue, Rocklin Road/Granite Drive, and Rocklin Road/I-80
Westbound Ramps

- Construction Year AM Peak Hour
 - Northbound SR 65: I-80 Eastbound Connector Ramp
 - Southbound SR 65: Sunset Boulevard off-ramp to on-ramp, Sunset Boulevard westbound on-ramp, and Galleria Boulevard on-ramp
 - Westbound I-80: from Antelope Road off-ramp to eastbound Elkhorn Boulevard on-ramp
 - Intersections: Rocklin Road/I-80 Eastbound Ramps
- Construction Year PM Peak Hour
 - Northbound SR 65: I-80 Eastbound Connector Ramp
 - Eastbound I-80: from Auburn Boulevard on-ramp to SR 65 off-ramp
 - Intersections: Blue Oaks Boulevard/Washington Boulevard/SR 65 Southbound Ramps, Stanford Ranch Road/Five Star Boulevard, Atlantic Street/Wills Road, Eureka Road/Sunrise Avenue, Douglas Boulevard/I-80 Eastbound Ramps, Rocklin Road/Granite Drive, and Rocklin Road/I-80 Eastbound Ramps

Alternative 2 (General Purpose Lane)

- Design Year AM Peak Hour
 - Southbound SR-65: Pleasant Grove Boulevard westbound on-ramp and Pleasant Grove Boulevard eastbound on-ramp
 - Westbound I-80: from Antelope Road westbound on-ramp to Elkhorn Boulevard eastbound on-ramp except for Elkhorn Boulevard off-ramp
 - Intersections: Blue Oaks Boulevard/Washington Boulevard/SR 65 Southbound Ramps, Roseville Parkway/Taylor Road, and Eureka Road/Sunrise Avenue
- Design Year PM Peak Hour
 - Intersections: Blue Oaks Boulevard/Washington Boulevard/SR 65 Southbound Ramps, Blue Oaks Boulevard/SR 65 Northbound Ramps, Stanford Ranch Road/Five Star Boulevard, Galleria Boulevard/Roseville Parkway, Roseville Parkway/Creekside Ridge Drive, Eureka Road/Taylor Road/I-80 Eastbound Ramps, Eureka Road/Sunrise Avenue, Douglas Boulevard/Harding Boulevard, Douglas Boulevard/I-80 Eastbound Ramps, Douglas Boulevard/Sunrise Avenue, Pacific Street/Sunset Boulevard, Rocklin Road/Granite Drive, and Rocklin Road/I-80 Westbound Ramps

- Construction Year AM Peak Hour
 - Northbound SR 65: I-80 Eastbound Connector Ramp
 - Southbound SR 65: Sunset Boulevard off-ramp to on-ramp and Sunset Boulevard westbound on-ramp
 - Westbound I-80: from Antelope Road off-ramp to eastbound Elkhorn Boulevard on-ramp
 - Intersections: Rocklin Road/I-80 Eastbound Ramps
- Construction Year PM Peak Hour
 - Northbound SR 65: I-80 Eastbound Connector Ramp
 - Eastbound I-80: from Douglas Boulevard eastbound off-ramp to SR 65 off-ramp
 - Intersections: Blue Oaks Boulevard/Washington Boulevard/SR 65 Southbound Ramps, Stanford Ranch Road/Five Star Boulevard, Galleria Boulevard/SR 65 Southbound Ramps, Atlantic Street/Wills Road, Eureka Road/Sunrise Avenue, Douglas Boulevard/Harding Boulevard, Douglas Boulevard/I-80 Eastbound Ramps, Douglas Boulevard/Sunrise Avenue, Rocklin Road/Granite Drive, and Rocklin Road/I-80 Eastbound Ramps

Alternative 3 (No Build)

- Design Year AM Peak Hour
 - Southbound SR 65: from Sunset Boulevard westbound on-ramp to Pleasant Grove Boulevard eastbound on-ramp
 - Westbound I-80: from the Antelope Road off-ramp to Elkhorn Boulevard eastbound on-ramp except for Elkhorn Boulevard off-ramp
 - Intersections: Blue Oaks Boulevard/Washington Boulevard/SR 65 Southbound Ramps, Roseville Parkway/Taylor Road, Eureka Road/Sunrise Avenue, and Rocklin Road/I-80 Eastbound Ramps
- Design Year PM Peak Hour
 - Northbound SR 65: I-80 to Stanford Ranch Road on-ramp
 - Southbound SR 65: Blue Oaks Boulevard westbound on-ramp to Pleasant Grove Boulevard eastbound on-ramp
 - Eastbound I-80: from the Eureka Road off-ramp to SR 65 off-ramp and the collector-distributor roadway between Eureka Road and SR 65/Taylor Road
 - Intersections: Blue Oaks Boulevard/Washington Boulevard/SR 65 Southbound Ramps, Blue Oaks Boulevard/SR 65 Northbound Ramps, Stanford Ranch Road/Five Star Boulevard, Galleria Boulevard/Roseville Parkway, Roseville Parkway/Creekside Ridge Drive,

Roseville Parkway/Taylor Road, Roseville Parkway/Sunrise Avenue, Eureka Road/Taylor Road/I-80 Eastbound Ramps, Eureka Road/Sunrise Avenue, Douglas Boulevard/I-80 Eastbound Ramps, Douglas Boulevard/Sunrise Avenue, Pacific Street/Sunset Boulevard, Rocklin Road/Granite Drive, and Rocklin Road/I-80 Westbound Ramps

- Construction Year AM Peak Hour
 - Southbound SR 65: from Sunset Boulevard to the Pleasant Grove Boulevard off-ramp
 - Westbound I-80: from Riverside Avenue to Elkhorn Boulevard eastbound on-ramp
 - Intersections: Blue Oaks Boulevard/Washington Boulevard/SR 65 Southbound Ramps, Roseville Parkway/Taylor Road, and Rocklin Road/I-80 Eastbound Ramps
- Construction Year PM Peak Hour
 - Northbound SR 65: I-80 Eastbound Connector Ramp
 - Eastbound I-80: Auburn Boulevard on-ramp to SR 65 off-ramp
 - Intersections: Blue Oaks Boulevard/Washington Boulevard/SR 65 Southbound Ramps, Blue Oaks Boulevard/SR 65 Northbound Ramps, Stanford Ranch Road/Five Star Boulevard, Eureka Road/Sunrise Avenue, Douglas Boulevard/Harding Boulevard, Pacific Street/Sunset Boulevard, Rocklin Road/Granite Drive, and Rocklin Road/I-80 Westbound Ramps

6.2. Project Impacts

The project impacts are summarized below by alternative. A project impact occurs where (1) the LOS threshold is exceeded and (2) the conditions are worse than the no build alternative (Alternative 3).

Alternative 1 (Carpool Lane)

- Design Year AM Peak Hour
 - Westbound I-80: from the Truck Scales to Elkhorn Boulevard eastbound on-ramp
 - Intersections: Roseville Parkway/Taylor Road
- Design Year PM Peak Hour
 - Intersections: Douglas Boulevard/Harding Boulevard, Douglas Boulevard/Sunrise Avenue, and Rocklin Road/I-80 Westbound Ramps
- Construction Year AM Peak Hour
 - Northbound SR 65: I-80 Eastbound Connector Ramp

- Southbound SR 65: Sunset Boulevard off-ramp to on-ramp, Sunset Boulevard westbound on-ramp, and Galleria Boulevard on-ramp
- Intersections: Rocklin Road/I-80 Eastbound Ramps
- Construction Year PM Peak Hour
 - Eastbound I-80: from Auburn Boulevard on-ramp to SR 65
 - Intersections: Stanford Ranch Road/Five Star Boulevard, Atlantic Street/Wills Road, Douglas Boulevard/I-80 Eastbound Ramps, Rocklin Road/Granite Drive, and Rocklin Road/I-80 Eastbound Ramps

Alternative 2 (General Purpose Lane)

- Design Year AM Peak Hour
 - Westbound I-80: Truck Scales on-ramp
 - Intersections: Roseville Parkway/Taylor Road
- Design Year PM Peak Hour
 - Intersections: Douglas Boulevard/Harding Boulevard, Douglas Boulevard/Sunrise Avenue, and Rocklin Road/I-80 Westbound Ramps
- Construction Year AM Peak Hour
 - Northbound SR 65: I-80 Eastbound Connector Ramp
 - Southbound SR 65: Sunset Boulevard off-ramp to on-ramp and Sunset Boulevard westbound on-ramp
 - Intersections: Rocklin Road/I-80 Eastbound Ramps
- Construction Year PM Peak Hour
 - Northbound SR 65: I-80 Eastbound Connector Ramp
 - Eastbound I-80: Douglas Boulevard on-ramp and Eureka Road off-ramp
 - Intersections: Stanford Ranch Road/Five Star Boulevard, Atlantic Street/Wills Road, Douglas Boulevard/Harding Boulevard, Douglas Boulevard/I-80 Eastbound Ramps, Douglas Boulevard/Sunrise Avenue, Rocklin Road/Granite Drive, and Rocklin Road/I-80 Eastbound Ramps

6.3. Potential Mitigation Measures

The potential mitigation measures for the project impacts identified in the previous section are provided below.

Northbound SR 65

- The impact to the I-80 eastbound connector ramp under construction year conditions can be mitigated by constructing the ultimate phase of the I-80/SR 65 Interchange Improvements project.

Southbound SR 65

- The impact at Sunset Boulevard under construction year conditions can be mitigated by extending the proposed auxiliary lane upstream to start at the westbound on-ramp instead of the eastbound on-ramp at Sunset Boulevard. Since the auxiliary lane extension is not needed under design year conditions when mainline is widened, an alternate mitigation would be to operate the ramp meters on southbound SR 65 at a more restrictive rate, which may cause secondary impacts to local streets.
- The impact to the Galleria Boulevard on-ramp under construction year conditions can be mitigated by constructing the ultimate phase of the I-80/SR 65 Interchange Improvements project. An alternate mitigation would be to operate the ramp meters on southbound SR 65 at a more restrictive rate, which may cause secondary impacts to local streets.

Eastbound I-80

- Impacts from Auburn Boulevard to SR 65 under construction year conditions can be mitigated by constructing the ultimate phase of the I-80/SR 65 Interchange Improvements project.

Westbound I-80

- Impacts from the Truck Scales to Elkhorn Boulevard can be mitigated by providing a full auxiliary lane from the truck scales to Elkhorn Boulevard or adding a through lane at Elkhorn Boulevard. An alternate mitigation to the above widening options would be to operate the ramp meters on westbound I-80 and southbound SR 65 at a more restrictive rate, which may cause secondary impacts to local streets.

Intersections

- Stanford Ranch Road/Five Star Boulevard – The impact may be mitigated by converting the eastbound middle lane from a shared left-turn/through lane to a shared left-turn/through/right-turn lane.
- Roseville Parkway/Taylor Road – The impact would likely be mitigated by providing a third southbound left-turn lane. With the widening of the approach, the pedestrian crossing distance would increase.
- Atlantic Street/Wills Road – The impact would likely be mitigated by modifying signal timing.

- Douglas Boulevard/Harding Boulevard – The impact would likely be mitigated by modifying signal timing. Alternately, an additional eastbound through lane would increase capacity.
- Douglas Boulevard/I-80 Eastbound Ramps – The impact would likely be mitigated by modifying signal timing or adjusting the ramp meter timing to reduce queuing onto the local street.
- Douglas Boulevard/Sunrise Avenue – This impact may be mitigated by modifying signal timing. Alternately, the addition of a second southbound right turn lane would increase capacity.
- Rocklin Road/Granite Drive – This impact under construction year conditions may be mitigated by constructing the planned I-80/Rocklin Road Interchange Improvements.
- Rocklin Road/I-80 Westbound Ramps – This impact may be mitigated by signal timing and/or providing additional storage for the ramp meter on the Rocklin Road on-ramp to westbound I-80 to reduce queuing onto the local street.
- Rocklin Road/I-80 Eastbound Ramps – This impact under construction year conditions may be mitigated by constructing the planned I-80/Rocklin Road Interchange Improvements.

6.4. Safety Assessment

The build alternatives will likely provide similar improvements to transportation safety. A key improvement will be provided by congestion reduction on the freeway. Rear-end collisions on the freeway are associated with congested conditions. As noted in the existing conditions section, rear-end collisions in the study area are highest on southbound SR 65 during the congested AM and PM peak periods. Since the build alternatives will reduce congestion compared to Alternative 3 (No Build), the expected number of rear-end collisions would be reduced with the build alternatives.

Roadway design standards are used to provide consistent expectations for drivers, which helps improve transportation safety by reducing collision risks. When these standards are not met, collision risks may increase. The currently proposed design exceptions related to freeway operations are narrow shoulder widths at the Blue Oaks Boulevard and Pleasant Grove Boulevard overcrossings. Compared to Alternative 3 (No Build), Alternatives 1 and 2 will have a narrower clear recovery zone at these two spot locations.

6.5. Comparison of Project Alternatives

In general, the build alternatives perform similarly under design year conditions. Table 31 compares the build alternatives across a range of performance measures based on the project objectives. As listed in Section 1.3, the project objectives can be summarized as reducing congestion and improving safety.

In the comparison summary table, two performance measures for the overall network performance are provided: the sum of the AM and PM peak period volume served (throughput) and vehicle hours of delay. The three build alternatives have similar performance, with less than 0.01 percent difference in volume

and less than 0.2 percent difference in delay between the alternatives. Alternative 1 (Carpool Lane) has the better network performance primarily due to the improved PM peak period operation for southbound SR 65.

The comparison table also lists the total number of design year AM and PM peak hour impacts for study freeway sections and intersections. Alternative 2 (General Purpose Lane) has the fewest freeway impacts; however, both alternatives have about the same performance on westbound I-80 during the AM peak hour where all of the impacts are located. The intersection impacts are at the same locations for both alternatives.

Category	Alternative 1	Alternative 2	Difference¹
Network Throughput (vehicles)	508,940	508,290	+650 (1)
Network Delay (vehicle-hours)	16,010	16,050	-40 (1)
Freeway Impacts	5	1	-4 (2)
Intersection Impacts	4	4	0 (-)
Northbound SR 65 PM Peak Hour Travel Time	7:52	7:53	-1 (1)
Southbound SR 65 AM Peak Hour Travel Time	7:49	7:53	-4 (1)
Note: 1. The alternative with the better performance is listed in parentheses.			
Source: Fehr & Peers, 2015			

The peak hour travel times for the peak directions of SR 65 are nearly the same. During the AM peak hour, the southbound travel time is lower for Alternative 1 by 4 seconds. The difference is small, but Alternative 1 provides a better overall travel time.

In summary, both build alternatives would meet the project need and purpose. Alternative 1 would provide better network conditions, better southbound freeway operations, and fewer intersection impacts.

Chapter 7. References

This chapter contains the references cited in the Transportation Analysis Report.

California Department of Transportation, District 3. May 2009. *Interstate 80 and Capital City Freeway Corridor System Management Plan*.

California Department of Transportation, District 3. May 2009. *State Route 65 Corridor Systems Management Plan*.

California Department of Transportation. Traffic Accident Surveillance and Analysis System. April 1, 2009 – March 31, 2012.

California Department of Transportation. *Highway Design Manual, 6th Edition*. March 2014.

California Transportation Commission. 2010. *2010 California Regional Transportation Guidelines*.

Cervero, R. August 2002. *Induced Travel Demand: Research Design, Empirical Evidence, and Normative Policies*.

City of Lincoln. March 2008. *City of Lincoln General Plan*.

City of Rocklin. October 2012. *City of Rocklin General Plan*.

City of Roseville. May 2010. *City of Roseville General Plan*.

Federal Highway Administration, 2004. *Traffic Analysis Toolbox Volume III: Guidelines for Applying Traffic Microsimulation Modeling Software*.

Fehr & Peers. August 2014. *I-80/SR 65 Interchange Improvements Transportation Analysis Report*.

Fehr & Peers. May 2015. *Placer I-80 Auxiliary Lanes Transportation Analysis Report*.

Sacramento Area Council of Governments. 2011. *2035 Metropolitan Transportation Plan/Sustainable Communities Strategy*.

Transportation Research Board. 2010. *Highway Capacity Manual*.



State Route 65
Capacity and Operational Improvements
Transportation Analysis Report Appendix

Placer County, CA
03-PLA-65-PM R6.5 to R12.9

EA 03-1F1700
Project ID 0300001103

September 2015



PLACER COUNTY
TRANSPORTATION
PLANNING AGENCY



Contents

I-80 Freeway Volume Figures

Intersection Volumes – Design Year

Intersection Volumes – Construction Year

VMT by Speed Bin

Freeway Analysis Results Summary Figures

Intersection Analysis Results Summary Tables

Ramp Meter Calculations

Vissim Model Results – Existing Conditions

Vissim Model Results – Design Year Alternative 1 (Carpool Lane)

Vissim Model Results – Design Year Alternative 2 (General Purpose Lane)

Vissim Model Results – Design Year Alternative 3 (No Build)

Vissim Model Results – Construction Year Alternative 1 (Carpool Lane)

Vissim Model Results – Construction Year Alternative 2 (General Purpose Lane)

Vissim Model Results – Construction Year Alternative 3 (No Build)

OD Adjustment Methodology Memorandum

Alternatives Screening Assessment Memorandum

SR 65 Capacity and Operational Improvements

I-80 Freeway Volume Figures

N:\2014\Projects\3201 - SR65 - Widening\Graphics\Final\Appendix\AM\XD\Design\Year - NO HOV\fig13A_year2040_Alt1.mxd

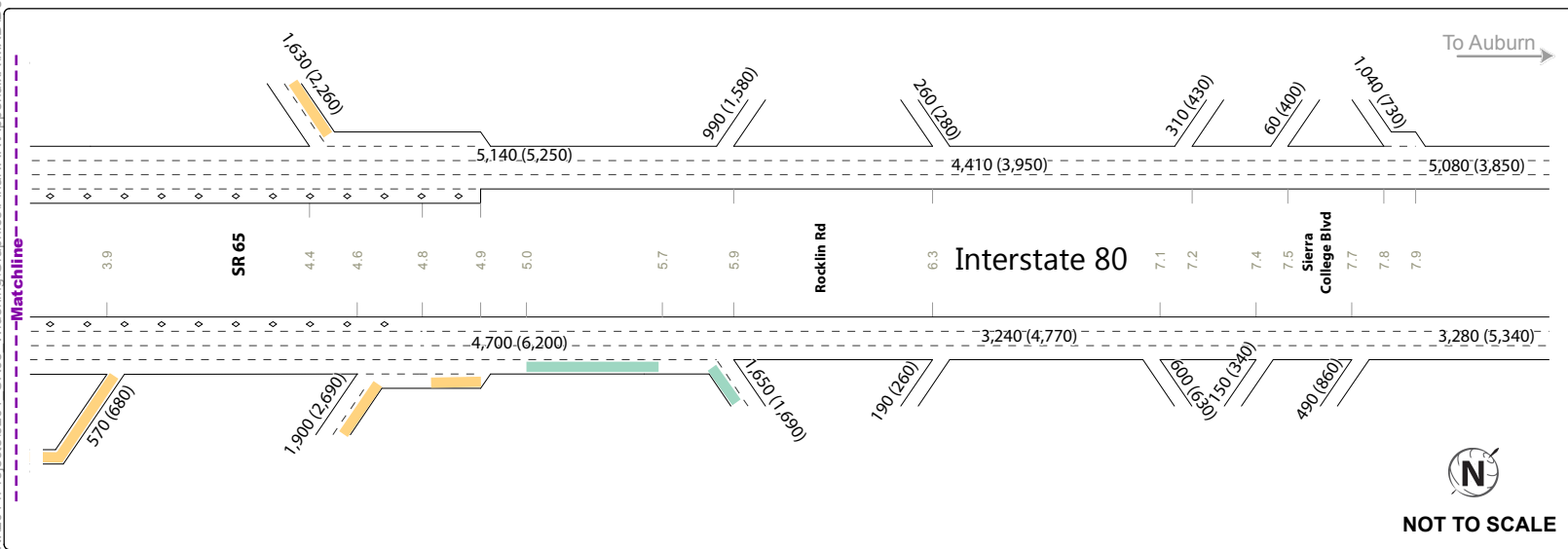
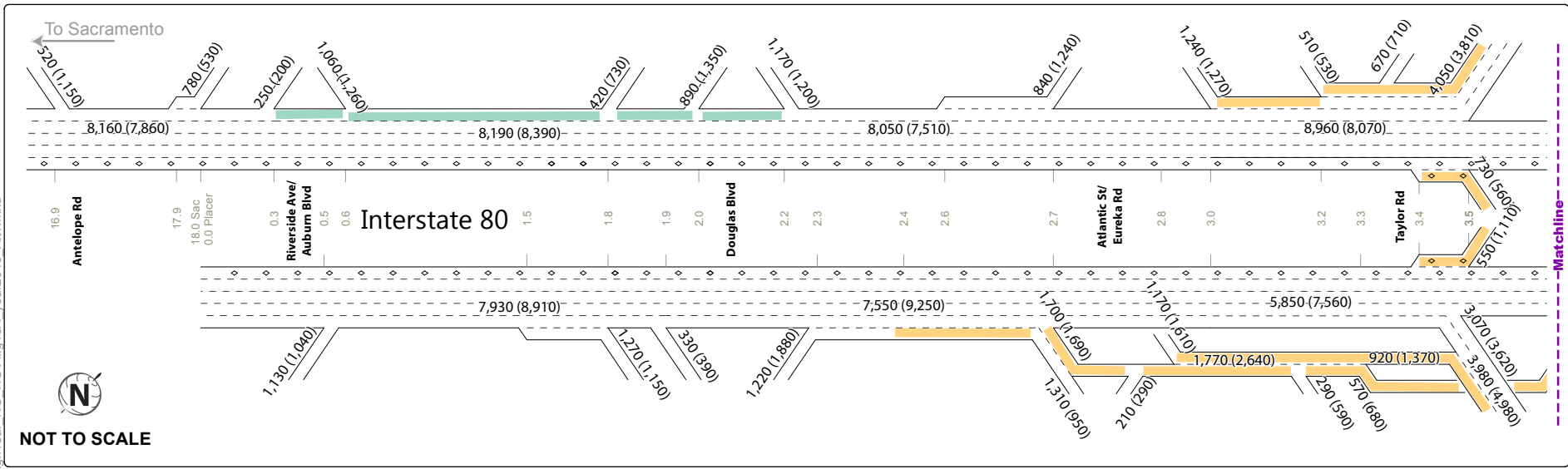

AM (PM) Peak Hour Traffic Volume for 2040 Conditions
 10.1 Postmile

■ Placer I-80 Auxiliary Lanes
■ I-80/SR 65 Interchange Improvements

Figure 13A

Design Year Peak Hour Traffic Volumes and Lane Configurations - Carpool Lane (Alternative 1)



N:\2014\Projects\3201 - SR65 - Widening\Graphics\Final\TAR\Appendix\AMXD\Design\Year NO HOV\fig14A_year2040_Alt2.mxd

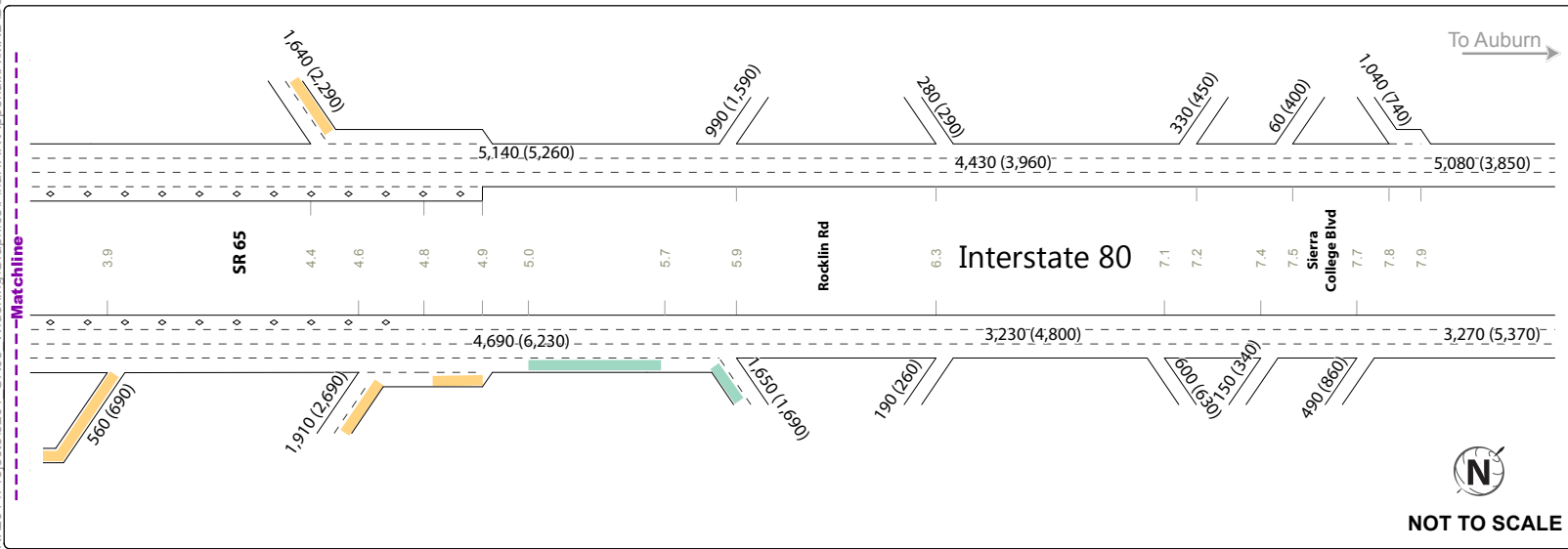
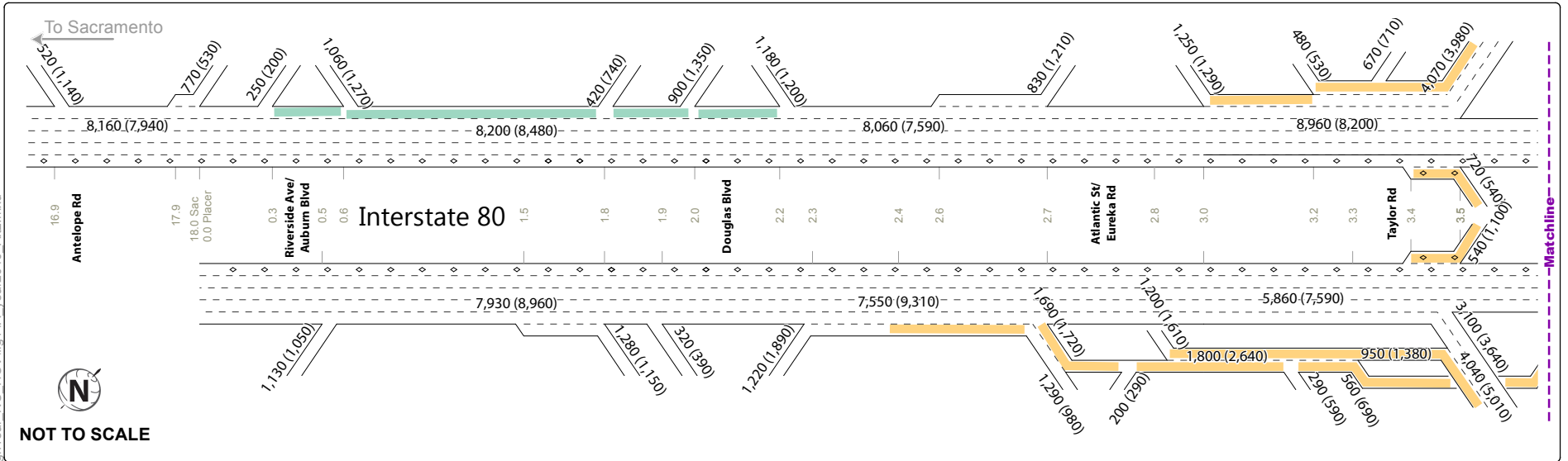

AM (PM) Peak Hour Traffic Volume for 2040 Conditions

10.1 Postmile

Placer I-80 Auxiliary Lanes

I-80/SR 65 Interchange Improvements

Figure 14A

Design Year Peak Hour Traffic Volumes and Lane Configurations - General Purpose Lane (Alternative 2)



N:\2014\Projects\3201 - SR65 - Widening\Graphics\Final\Appendix\AM\XD\Design\Year - NO HOV\fig15A_year2040_Alt3.mxd

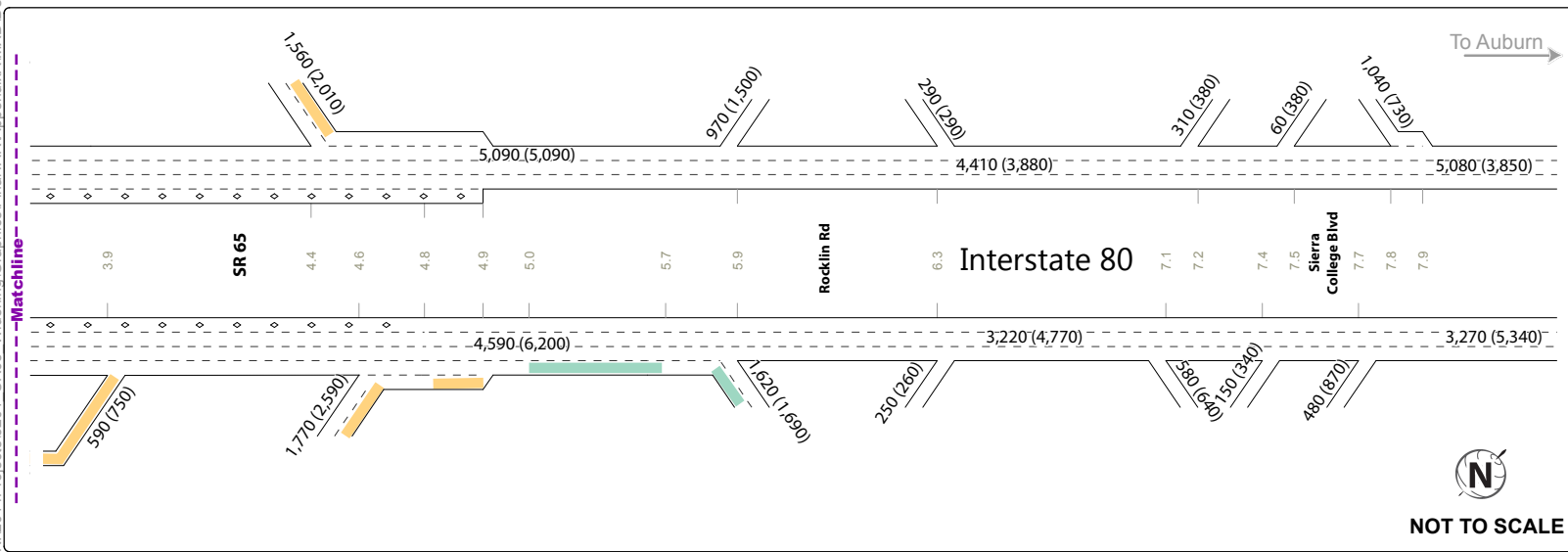
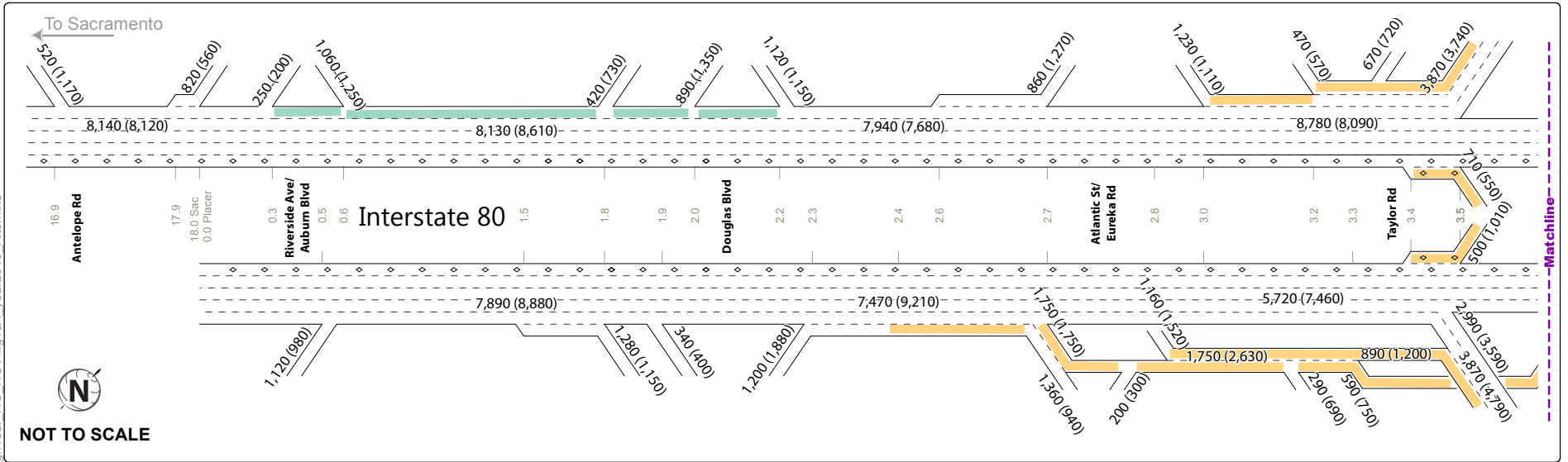

AM (PM) Peak Hour Traffic Volume for 2040 Conditions

10.1 Postmile

Placer I-80 Auxiliary Lanes

I-80/SR 65 Interchange Improvements

Figure 15A

Design Year Peak Hour Traffic Volumes and Lane Configurations - No Build (Alternative 3)



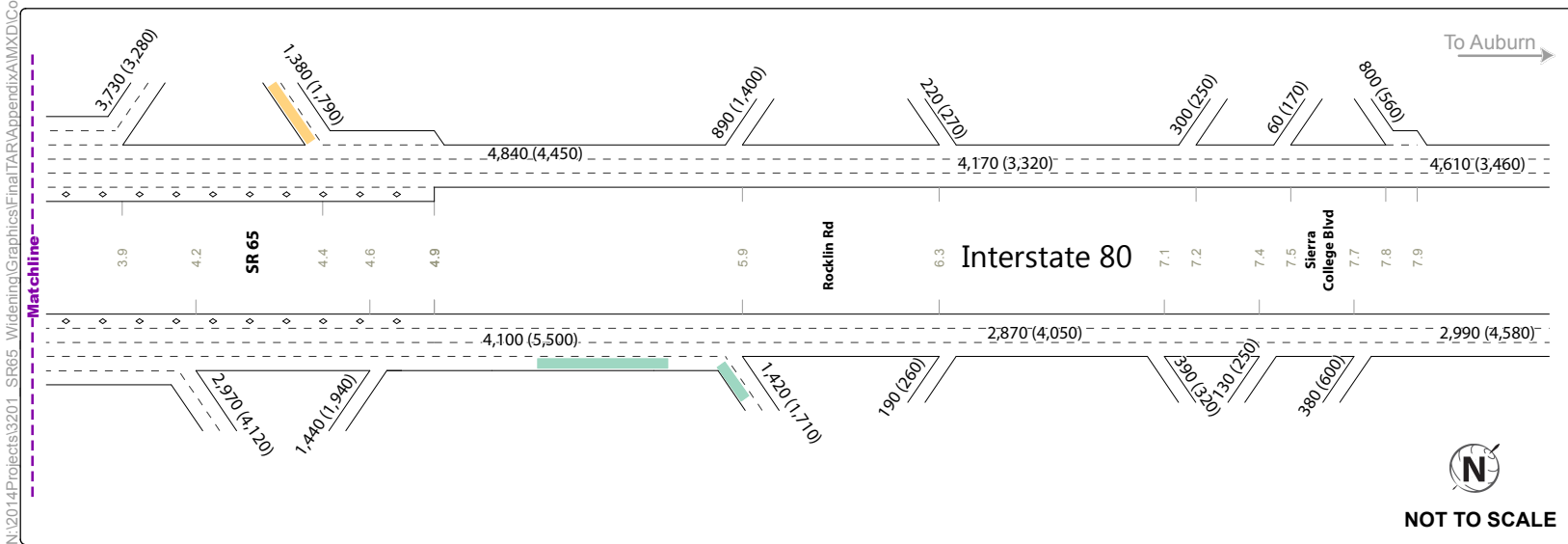
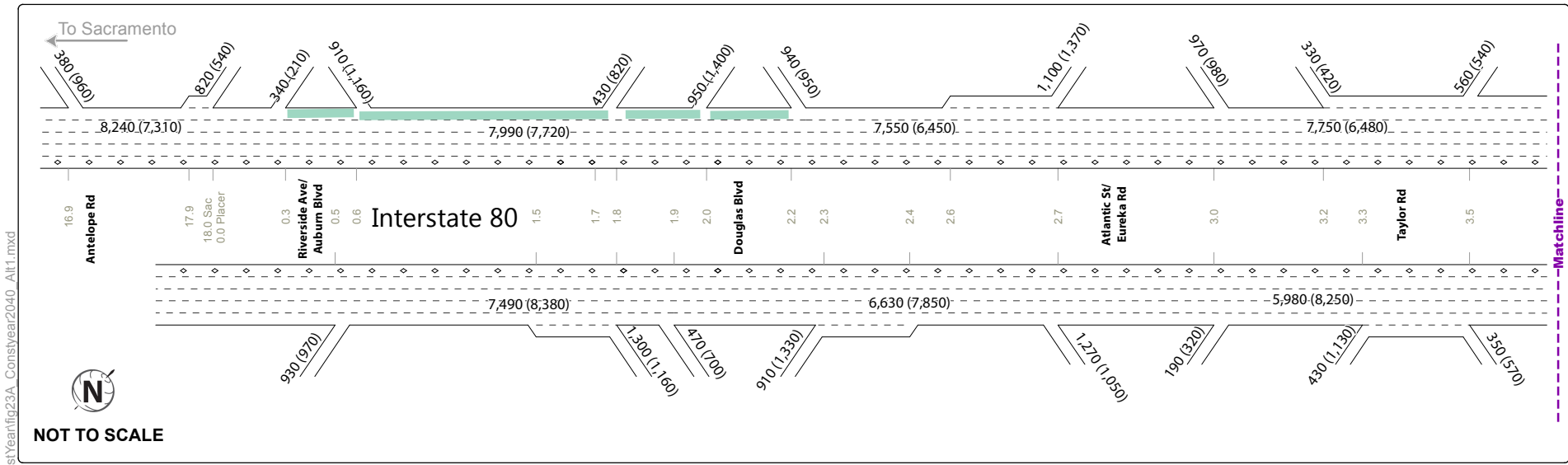

AM (PM) Peak Hour Traffic Volume for 2020 Conditions

10.1 Postmile

Placer I-80 Auxiliary Lanes

I-80/SR 65 Interchange Improvements Phase 1



Figure 23A
 Construction Year Peak Hour Traffic Volumes
 and Lane Configurations -
 Carpool Lane (Alternative 1)

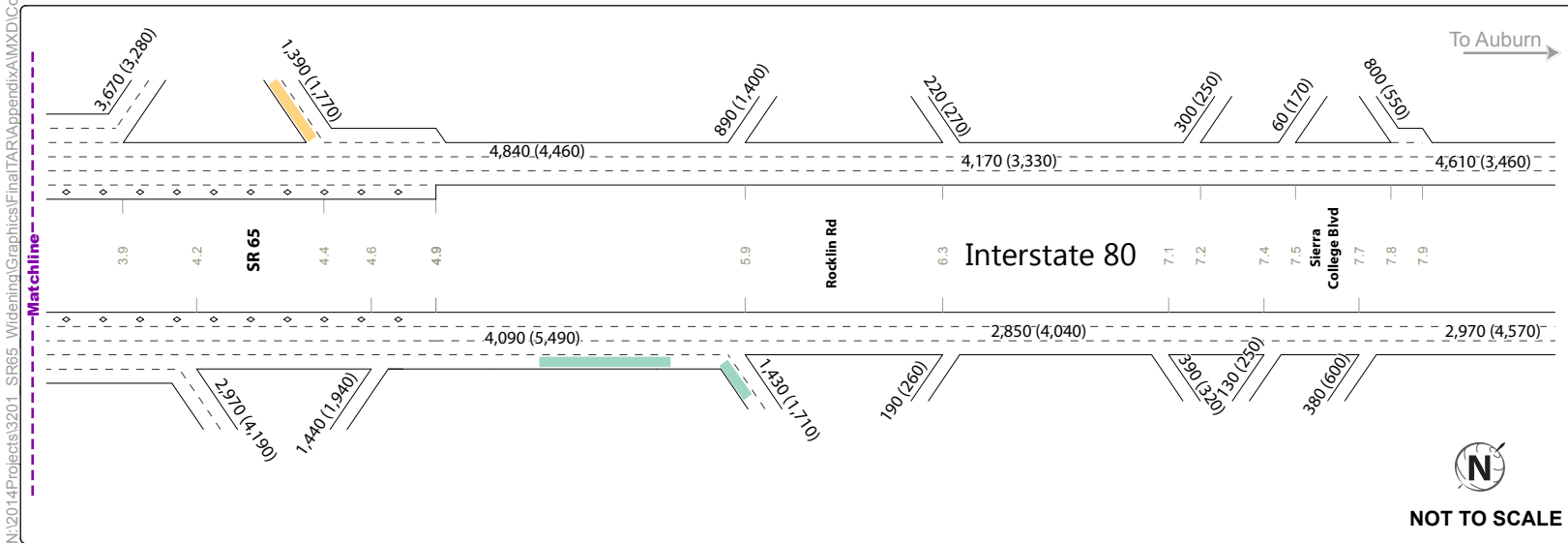
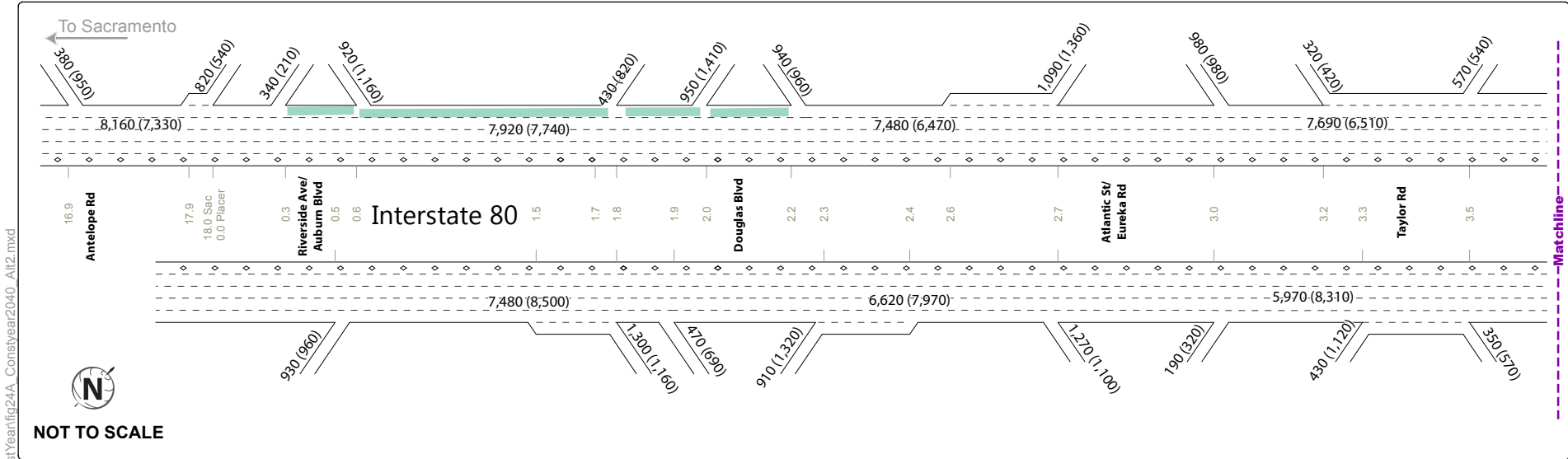

AM (PM) Peak Hour Traffic Volume for 2020 Conditions

10.1 Postmile

Placer I-80 Auxiliary Lanes

I-80/SR 65 Interchange Improvements Phase 1

Figure 24A

Construction Year Peak Hour Traffic Volumes and Lane Configurations - General Purpose Lane (Alternative 2)



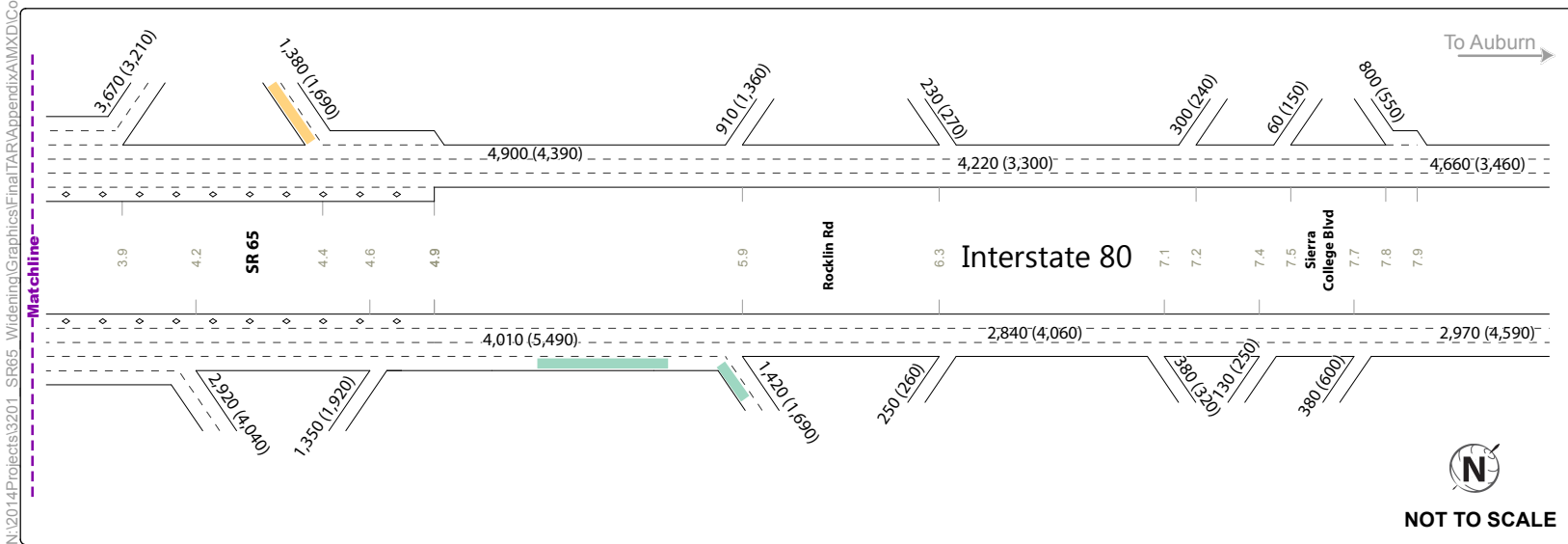
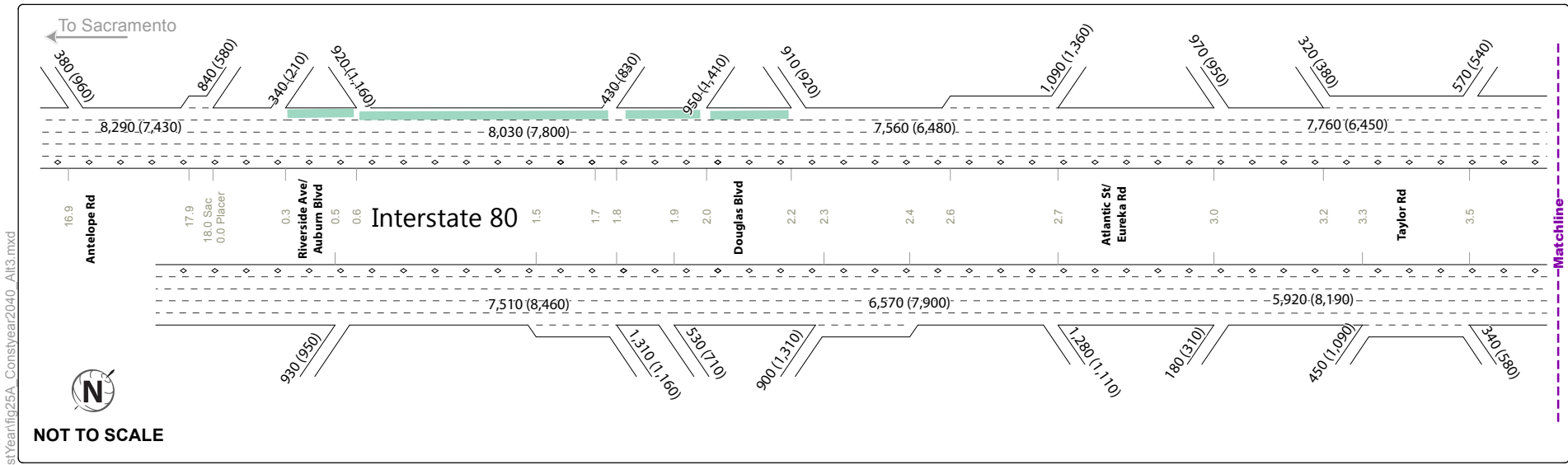

AM (PM) Peak Hour Traffic Volume for 2020 Conditions

10.1 Postmile

Placer I-80 Auxiliary Lanes

I-80/SR 65 Interchange Improvements Phase 1

Figure 25A

Construction Year Peak Hour Traffic Volumes and Lane Configurations - No Build (Alternative 3)



SR 65 Capacity and Operational Improvements

Intersection Volumes – Design Year

**SR-65 Capacity and Operational Improvements
Design Year Forecasts
AM (PM) Peak Hour Volumes**



**SR-65 Capacity and Operational Improvements
Design Year Forecasts
AM (PM) Peak Hour Volumes**



SR-65 Capacity and Operational Improvements
Design Year Forecasts
AM (PM) Peak Hour Volumes



**SR-65 Capacity and Operational Improvements
Design Year Forecasts
AM (PM) Peak Hour Volumes**



**SR-65 Capacity and Operational Improvements
Design Year Forecasts
AM (PM) Peak Hour Volumes**



**SR-65 Capacity and Operational Improvements
Design Year Forecasts
AM (PM) Peak Hour Volumes**



SR-65 Capacity and Operational Improvements
Design Year Forecasts
AM (PM) Peak Hour Volumes

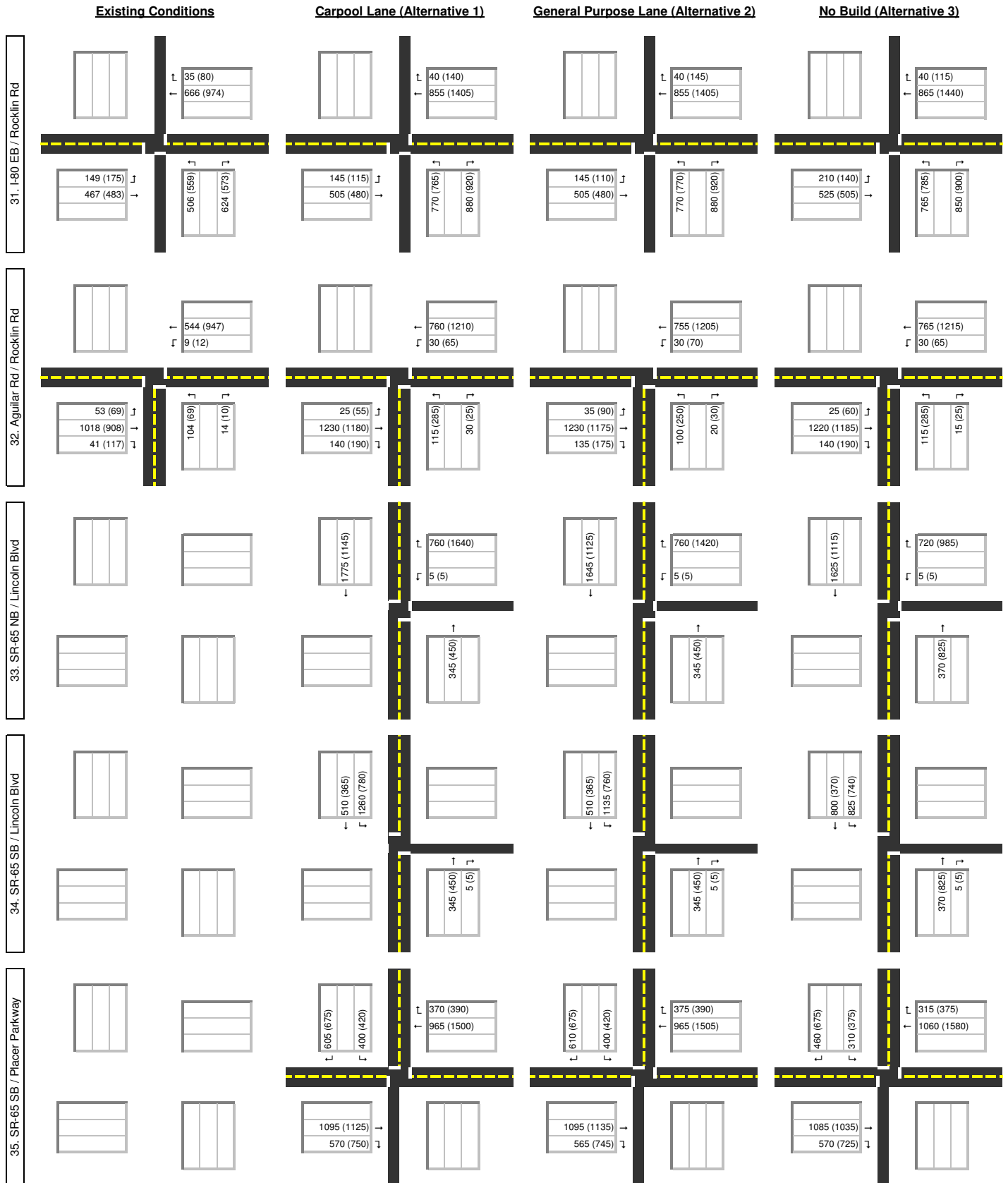

**SR-65 Capacity and Operational Improvements
Design Year Forecasts
AM (PM) Peak Hour Volumes**

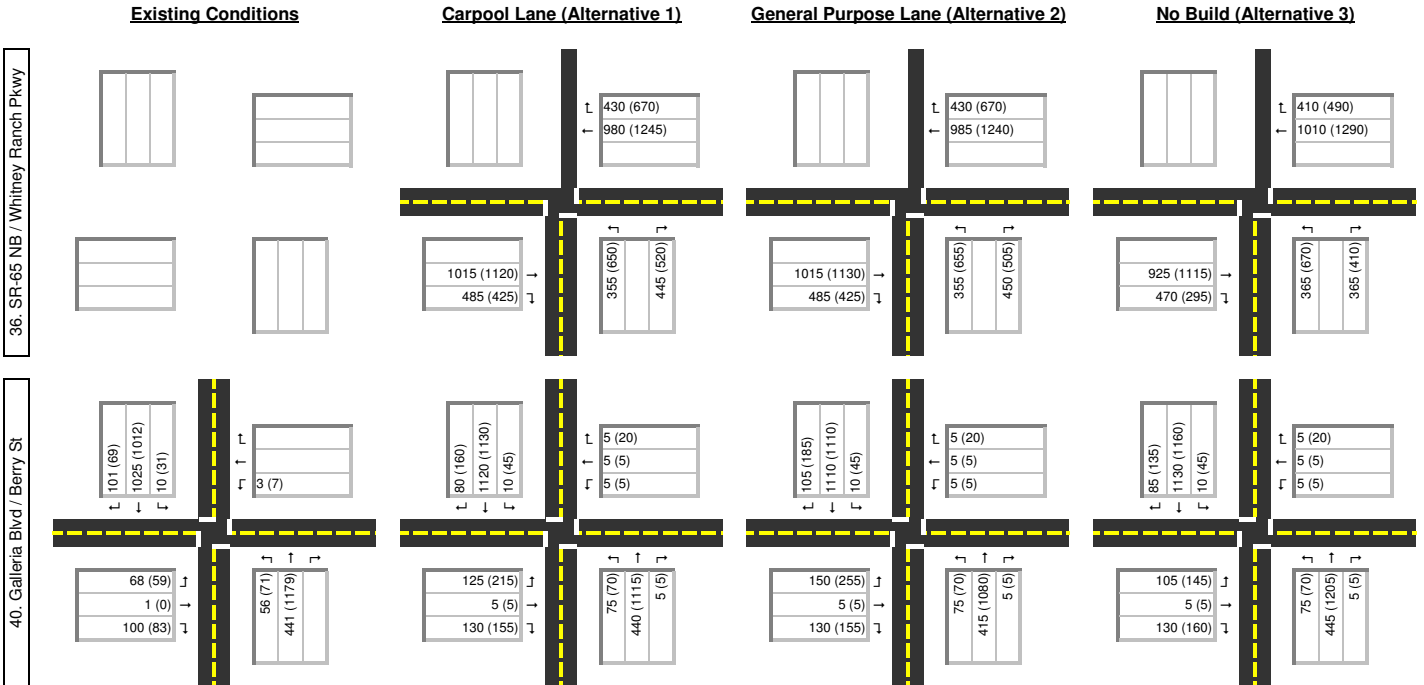

SR 65 Capacity and Operational Improvements

Intersection Volumes – Construction Year

**SR-65 Capacity and Operational Improvements
Construction Year Forecasts
AM (PM) Peak Hour Volumes**

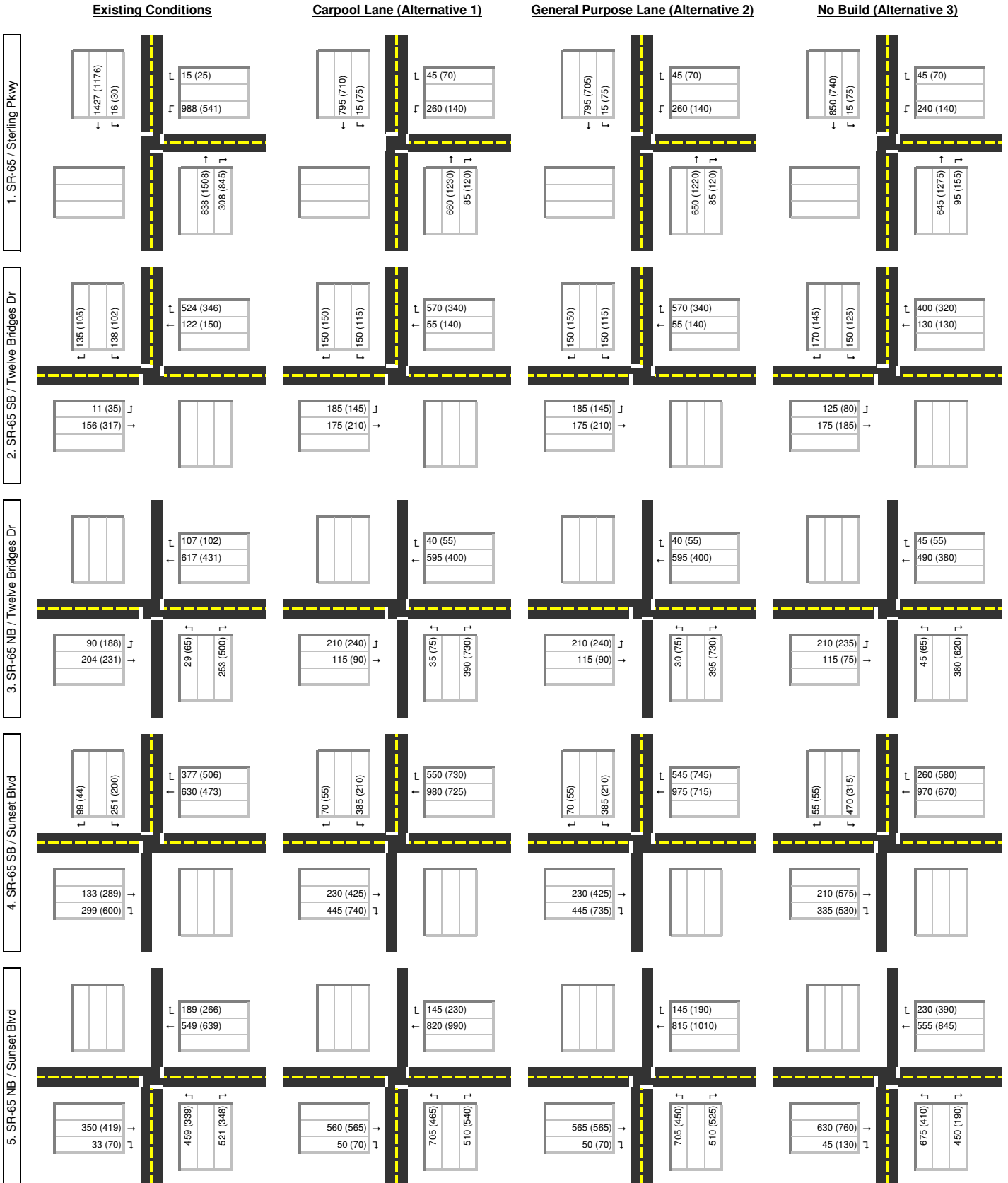

**SR-65 Capacity and Operational Improvements
Construction Year Forecasts
AM (PM) Peak Hour Volumes**



**SR-65 Capacity and Operational Improvements
Construction Year Forecasts
AM (PM) Peak Hour Volumes**



**SR-65 Capacity and Operational Improvements
Construction Year Forecasts
AM (PM) Peak Hour Volumes**



**SR-65 Capacity and Operational Improvements
Construction Year Forecasts
AM (PM) Peak Hour Volumes**



**SR-65 Capacity and Operational Improvements
Construction Year Forecasts
AM (PM) Peak Hour Volumes**



**SR-65 Capacity and Operational Improvements
Construction Year Forecasts
AM (PM) Peak Hour Volumes**



**SR-65 Capacity and Operational Improvements
Construction Year Forecasts
AM (PM) Peak Hour Volumes**

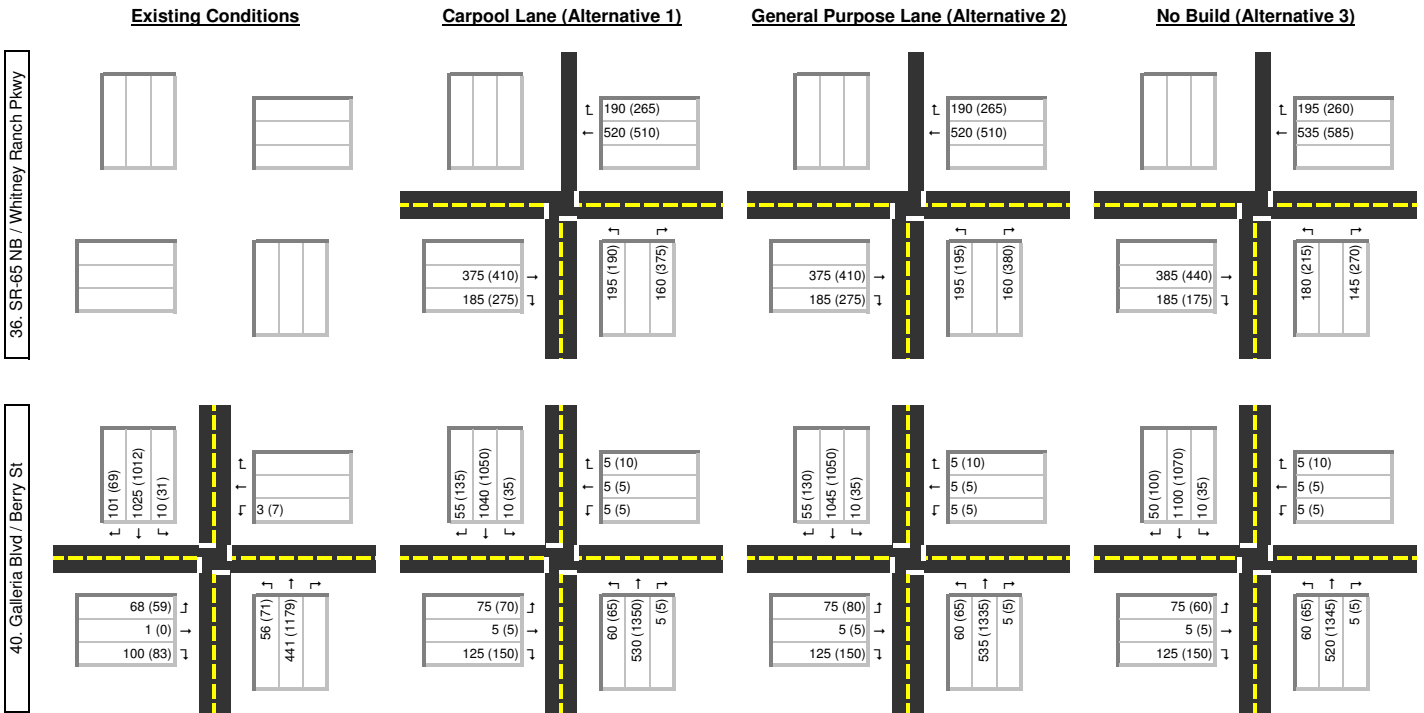

SR 65 Capacity and Operational Improvements

VMT by Speed Bin

**Alternative Comparison
Design Year**

AM Peak Period

Alternative	VMT by Speed Bin												
	0-5 mph	5-10 mph	10-15 mph	15-20 mph	20-25 mph	25-30 mph	30-35 mph	35-40 mph	40-45 mph	45-50 mph	50-55 mph	55-60 mph	60-65 mph
1 - Carpool Lane	7,713	29,415	91,604	144,041	167,329	205,287	287,770	302,803	210,745	147,033	185,615	162,216	60,507
2 - General Purpose Lane	7,715	29,420	91,028	144,909	161,536	212,111	282,798	301,576	205,628	136,559	193,551	174,338	61,625
3 - No Build	7,674	30,913	96,552	165,590	179,913	240,873	288,383	320,155	198,576	122,525	168,382	136,345	36,303

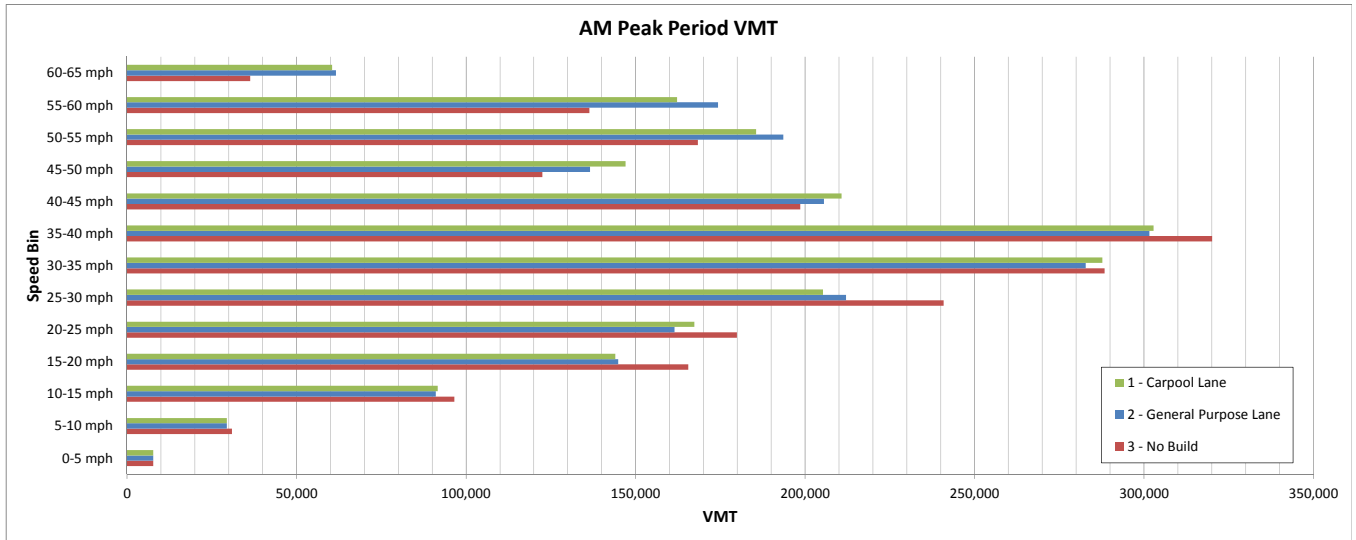

PM Peak Period

Alternative	VMT by Speed Bin												
	0-5 mph	5-10 mph	10-15 mph	15-20 mph	20-25 mph	25-30 mph	30-35 mph	35-40 mph	40-45 mph	45-50 mph	50-55 mph	55-60 mph	60-65 mph
1 - Carpool Lane	6,249	22,004	113,161	214,733	307,671	347,679	389,519	325,912	273,837	182,181	151,844	107,432	23,324
2 - General Purpose Lane	6,229	22,144	114,111	210,300	306,919	352,964	378,374	318,186	285,606	187,932	154,114	105,590	23,292
3 - No Build	6,259	22,386	133,296	270,745	349,950	354,232	391,268	313,898	252,585	138,757	135,430	66,047	16,478

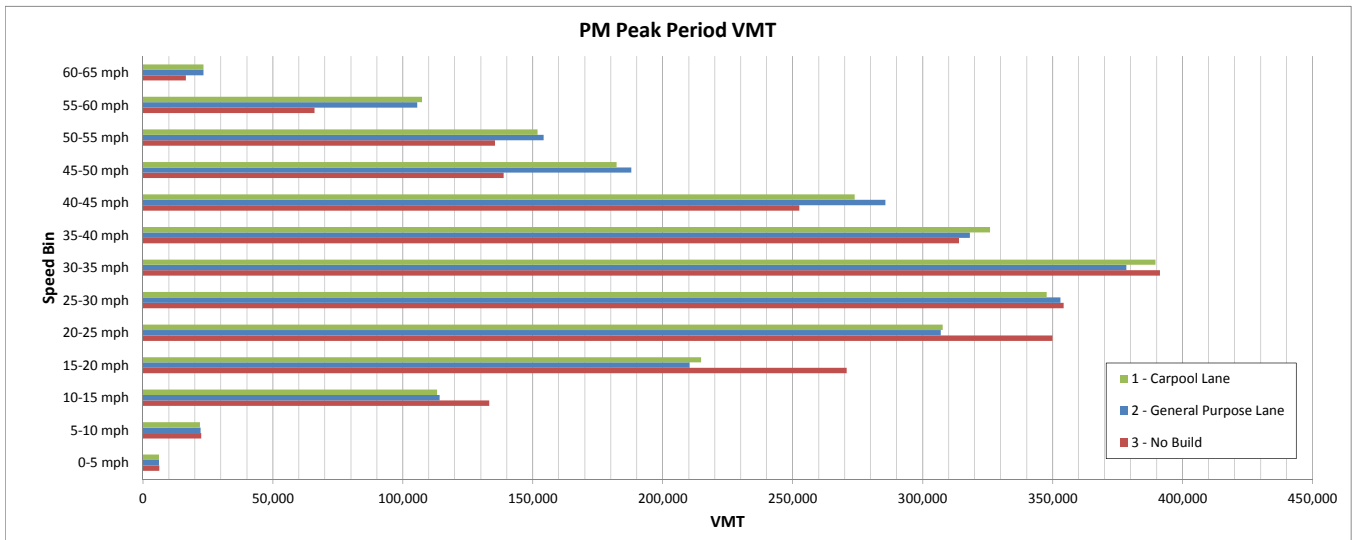

Alternative Comparison
Construction Year

AM Peak Period

Alternative	VMT by Speed Bin												
	0-5 mph	5-10 mph	10-15 mph	15-20 mph	20-25 mph	25-30 mph	30-35 mph	35-40 mph	40-45 mph	45-50 mph	50-55 mph	55-60 mph	60-65 mph
1 - Carpool Lane	4,841	23,580	60,076	124,588	153,118	165,103	178,115	246,057	200,697	83,148	152,837	153,499	105,440
2 - General Purpose Lane	4,842	23,436	60,283	124,652	153,880	163,496	178,578	244,661	203,117	80,398	148,503	159,720	105,788
3 - No Build	4,839	23,175	61,530	126,088	152,404	182,641	177,630	252,464	219,449	94,585	162,922	123,080	66,347

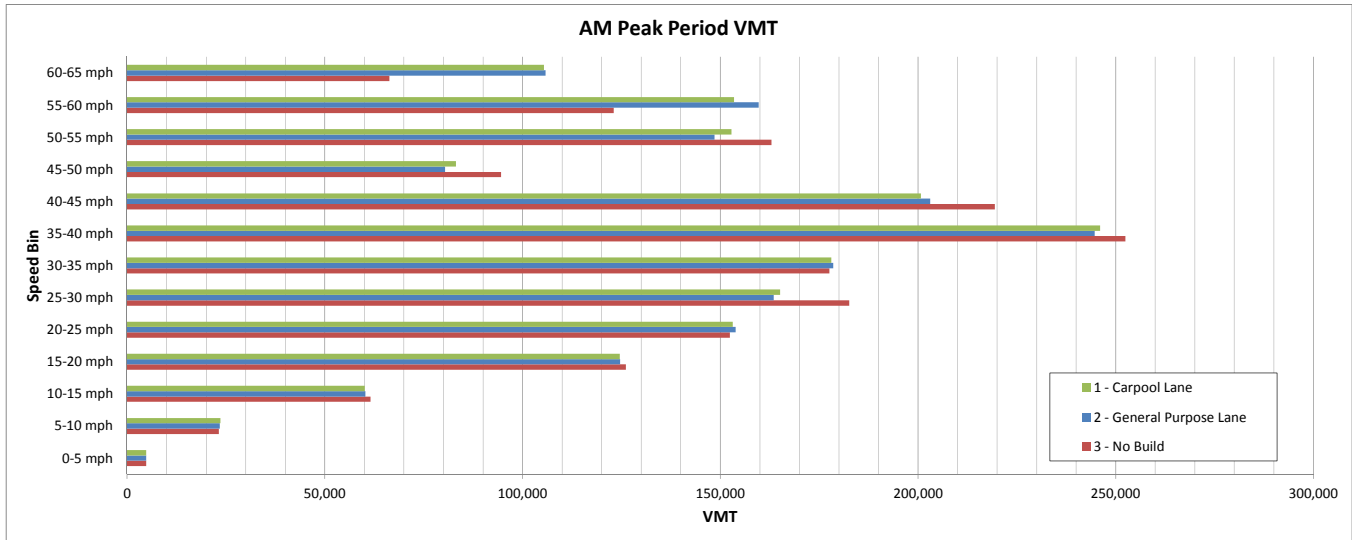

PM Peak Period

Alternative	VMT by Speed Bin												
	0-5 mph	5-10 mph	10-15 mph	15-20 mph	20-25 mph	25-30 mph	30-35 mph	35-40 mph	40-45 mph	45-50 mph	50-55 mph	55-60 mph	60-65 mph
1 - Carpool Lane	3,421	8,000	77,807	144,599	188,353	243,356	225,126	264,522	219,130	177,236	137,689	183,986	49,792
2 - General Purpose Lane	3,440	8,033	77,141	148,023	186,453	237,088	226,090	264,802	224,749	174,961	136,517	185,619	50,295
3 - No Build	3,414	7,010	78,308	148,851	198,961	267,934	243,080	279,975	213,537	175,998	153,674	127,583	18,720

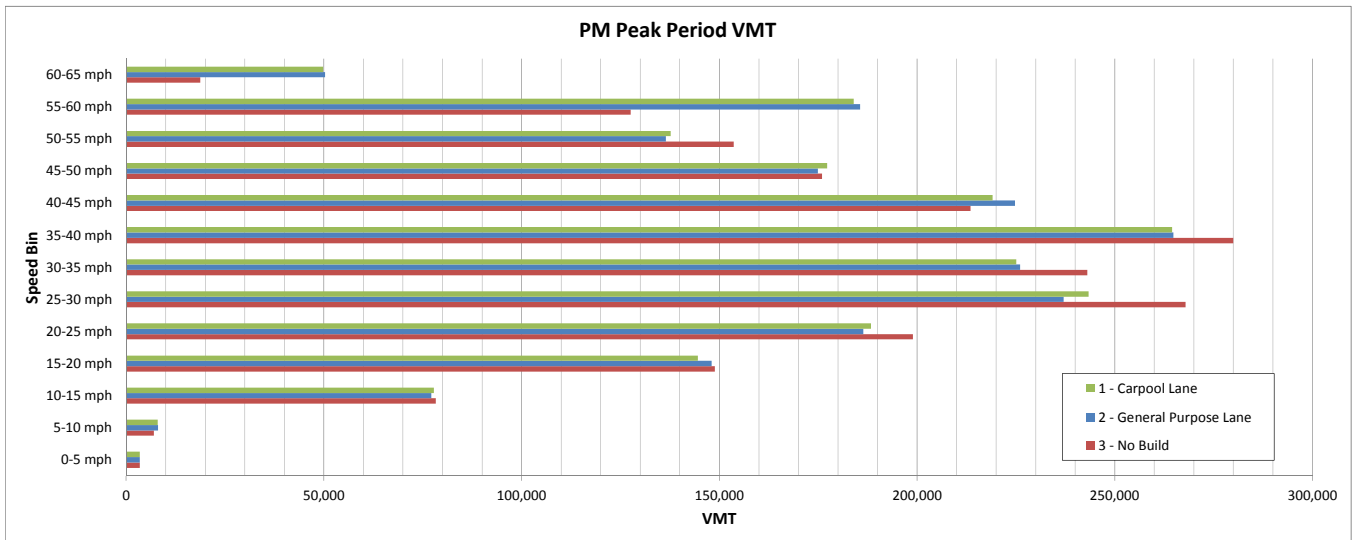

SR 65 Capacity and Operational Improvements

Freeway Analysis Results Summary Figures

Eastbound I-80

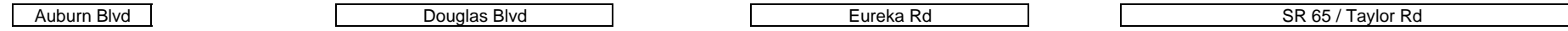

Alternative 1 - Carpool Lane

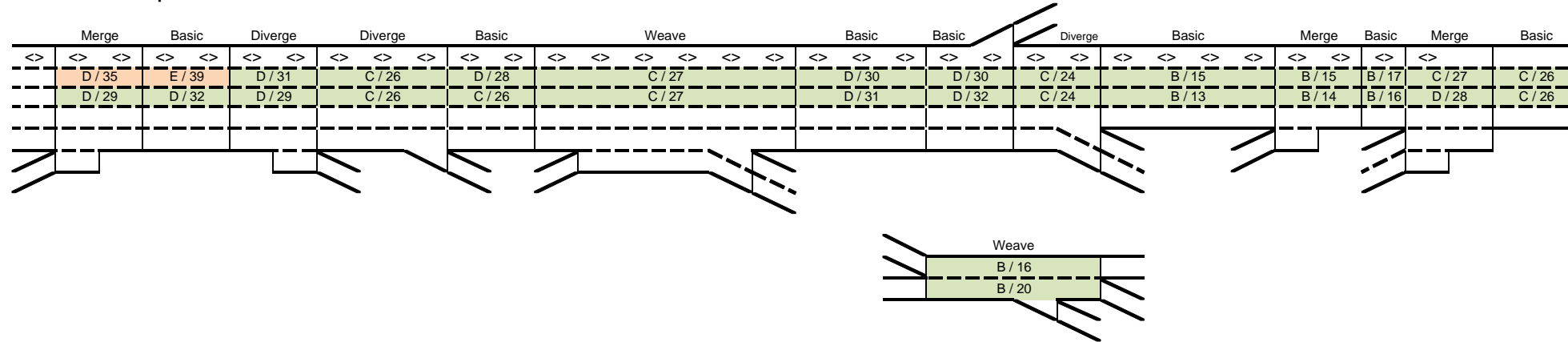

Alternative 2 - General Purpose Lane

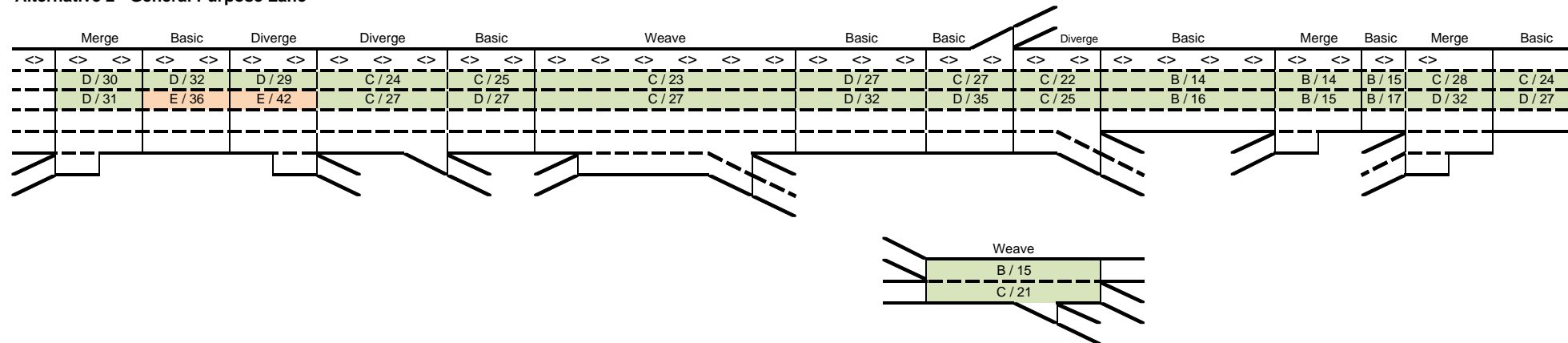

Alternative 3 - No Build

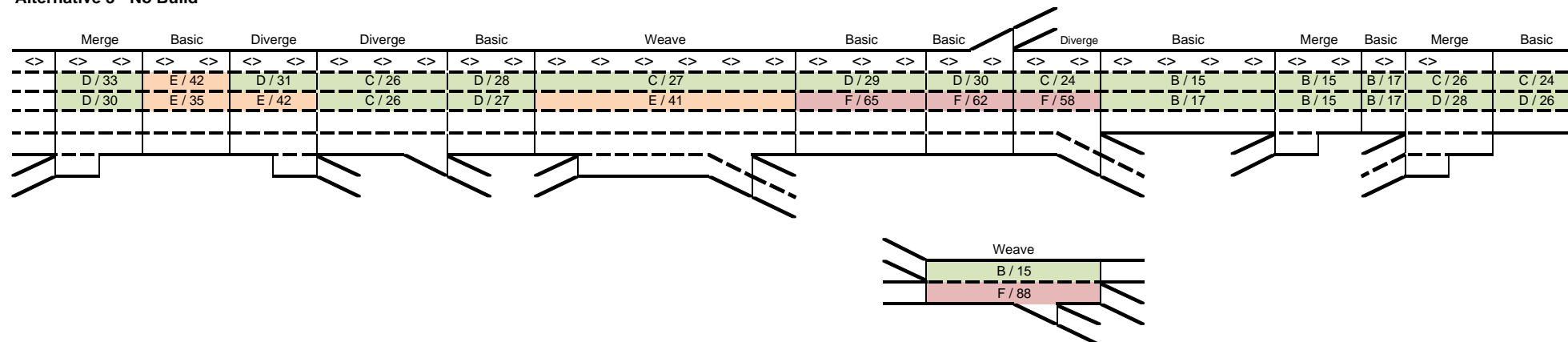

Legend:
 LOS A - D (Green)
 LOS E (Orange)
 LOS F (Red)
 Interchange (Box)
 HOV Lane (Diamond)
 Facility Type (Basic, Merge, Diverge, or Weave)
 AM Peak Hour LOS / Density
 PM Peak Hour LOS / Density
 F / 90 (Red) Project Impact

Eastbound I-80



Alternative 1 - Carpool Lane

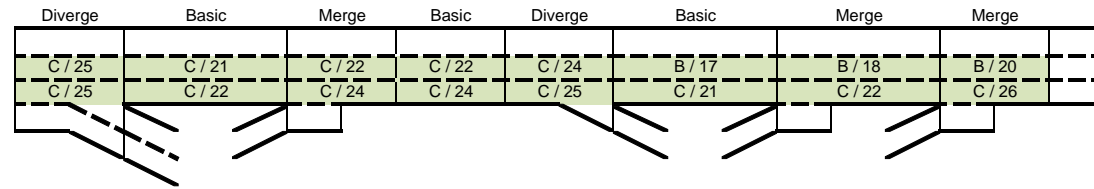

Alternative 2 - General Purpose Lane

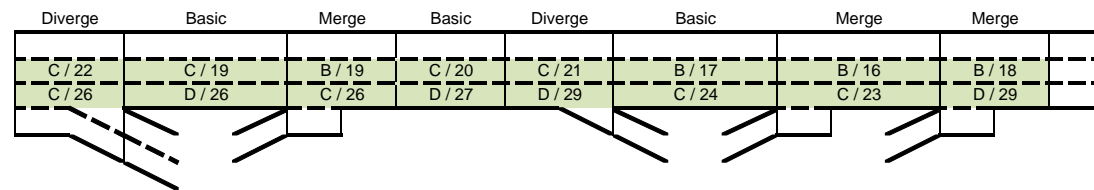

Alternative 3 - No Build

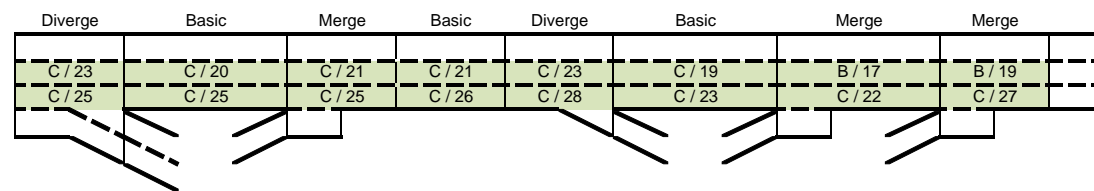

Legend:
 LOS A - D (Green)
 LOS E (Orange)
 LOS F (Red)
 Interchange (Box)
 <-> HOV Lane
 Facility Type (Basic, Merge, Diverge, or Weave)
 AM Peak Hour LOS / Density
 PM Peak Hour LOS / Density
 F / 90 (Red)
 Project Impact

Westbound I-80

Sierra College Blvd

Rocklin Rd

SR 65 / Taylor Rd

Atlantic St

Douglas Blvd

Alternative 1 - Carpool Lane

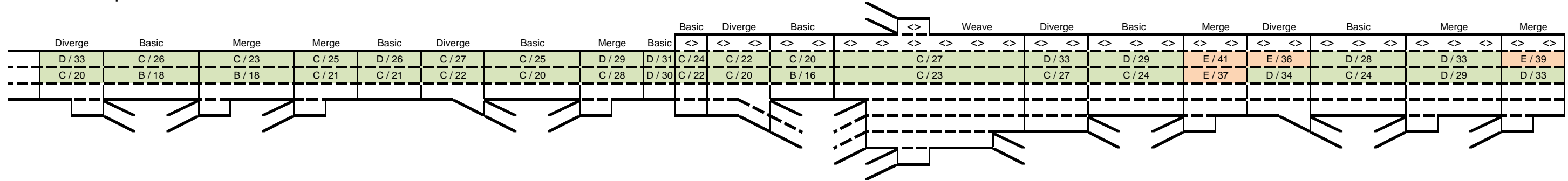

Alternative 2 - General Purpose Lane

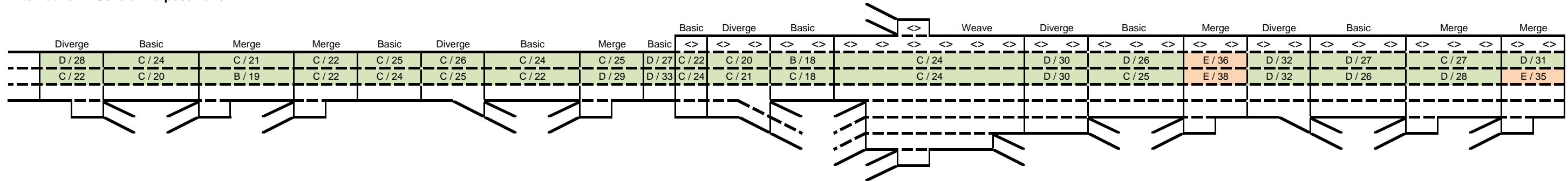

Alternative 3 - No Build

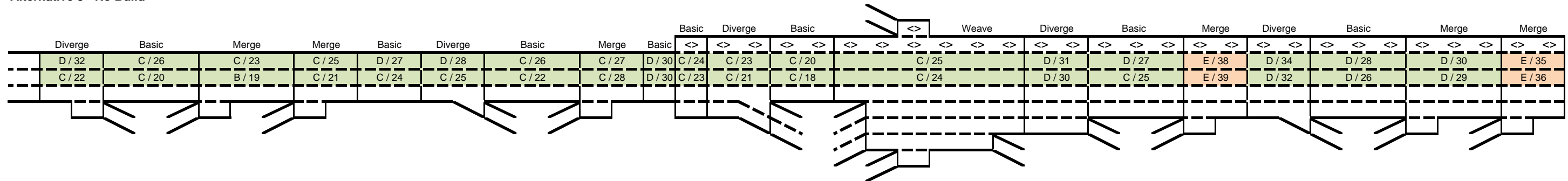

Legend:
 LOS A - D
 LOS E
 LOS F
Interchange
 HOV Lane
 AM Peak Hour LOS / Density
 PM Peak Hour LOS / Density
F/90 Project Impact
 Facility Type (Basic, Merge, Diverge, or Weave)

Westbound I-80

Riverside Ave

Antelope Road

Truck Scales

Elkhorn Blvd

Alternative 1 - Carpool Lane

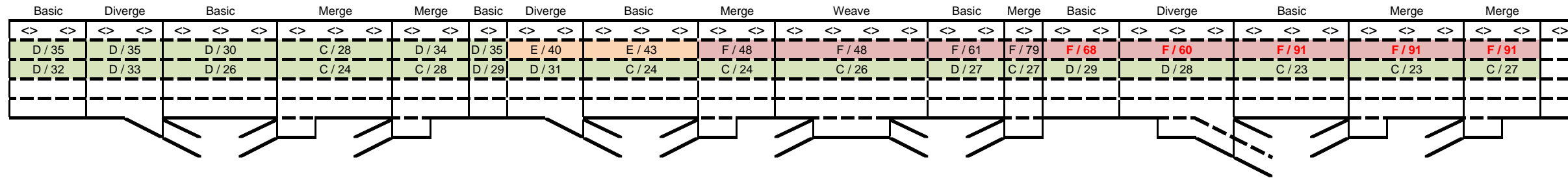

Alternative 2 - General Purpose Lane

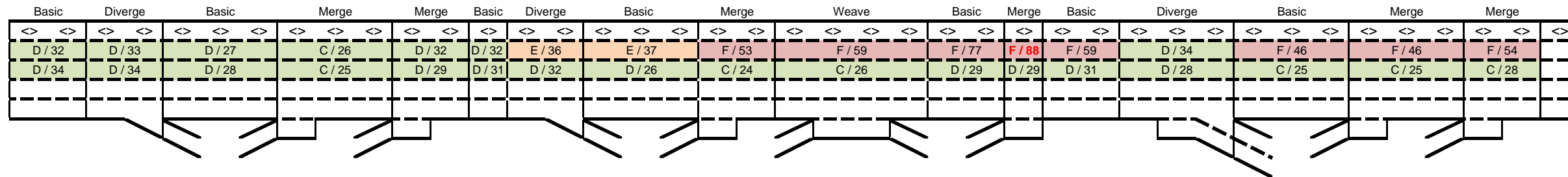

Alternative 3 - No Build

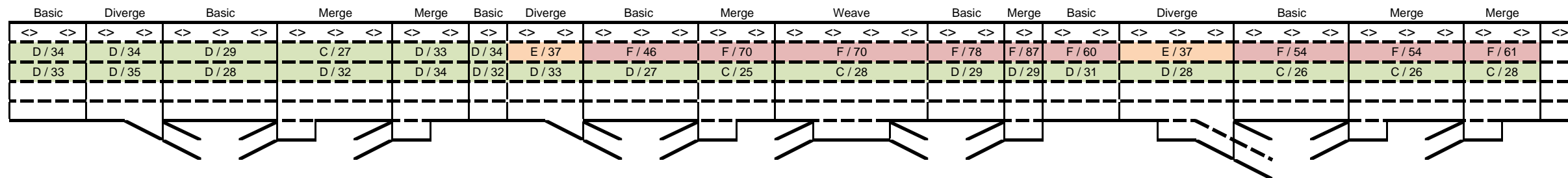

Legend:
 LOS A - D (Green)
 LOS E (Orange)
 LOS F (Red)
 Interchange (Box)
 HOV Lane (Chevron)
 Facility Type (Basic, Merge, Diverge, or Weave)
 AM Peak Hour LOS / Density
 PM Peak Hour LOS / Density
 F / 90 Project Impact

Northbound SR 65



Alternative 1 - Carpool Lane

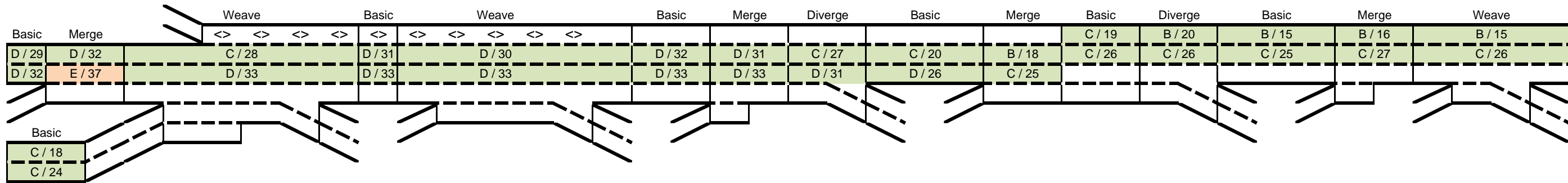

Alternative 2 - General Purpose Lane

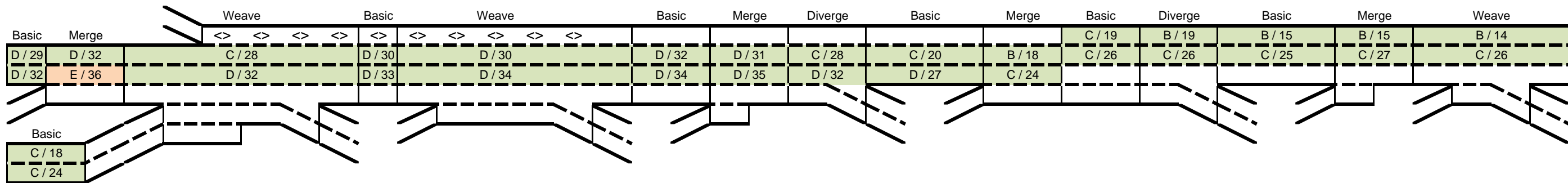

Alternative 3 - No Build

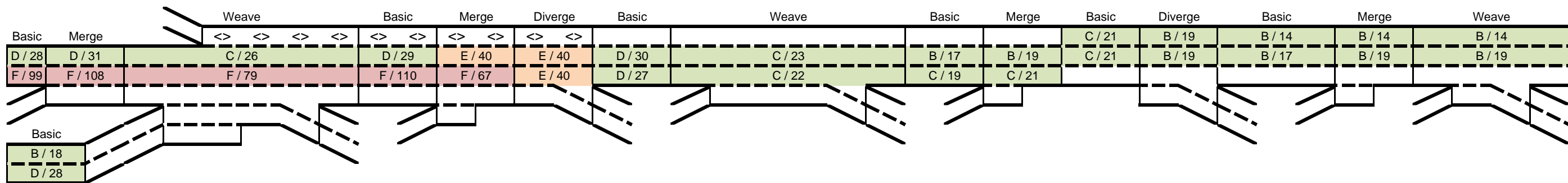

Legend:
 LOS A - D (Green)
 LOS E (Orange)
 LOS F (Red)
 Interchange
 <> HOV Lane
 Facility Type (Basic, Merge, Diverge, or Weave)
 AM Peak Hour LOS / Density
 PM Peak Hour LOS / Density
 F / 90 Project Impact

Northbound SR 65



Alternative 1 - Carpool Lane

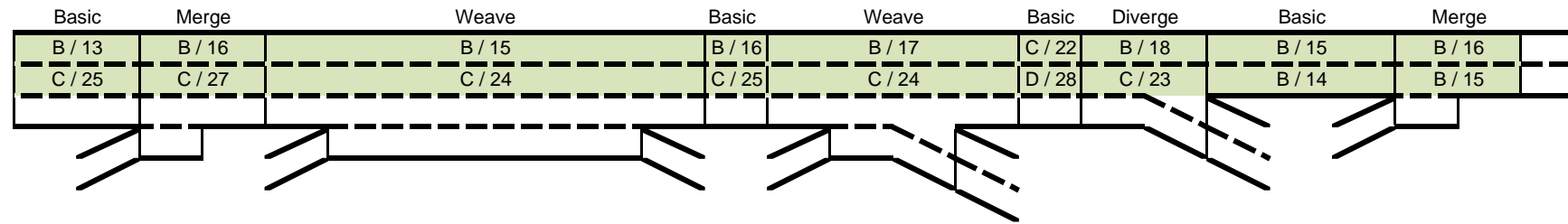

Alternative 2 - General Purpose Lane

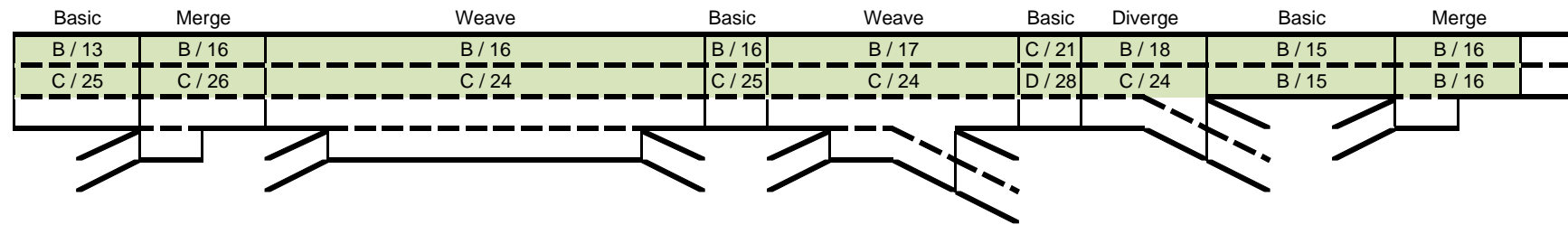

Alternative 3 - No Build

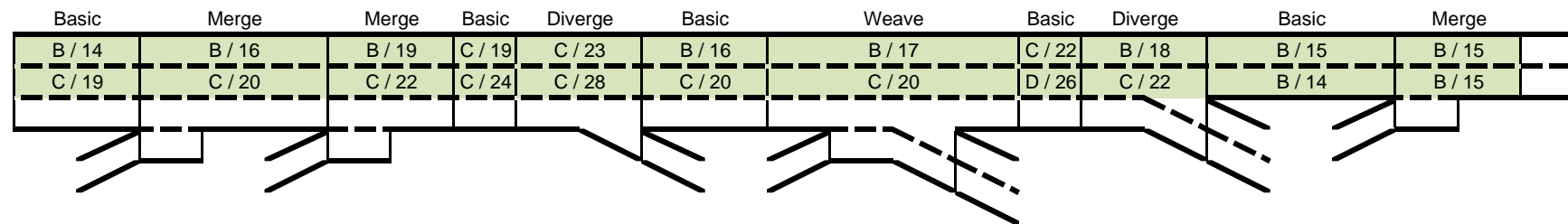

Legend: LOS A - D
 LOS E
 LOS F

Interchange AM Peak Hour LOS / Density
 <> HOV Lane PM Peak Hour LOS / Density
 Facility Type (Basic, Merge, Diverge, or Weave)

F / 90

Project Impact

Southbound SR 65



Alternative 1 - Carpool Lane

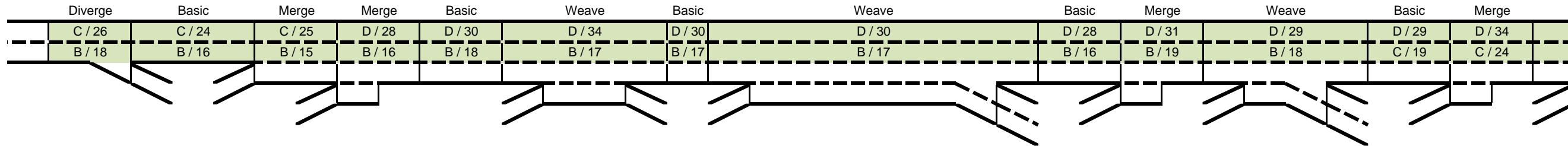

Alternative 2 - General Purpose Lane

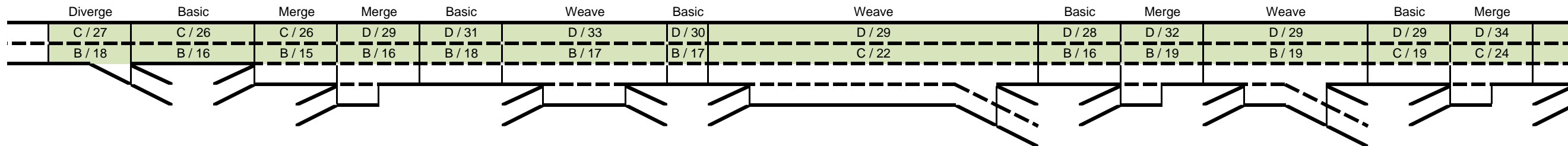

Alternative 3 - No Build

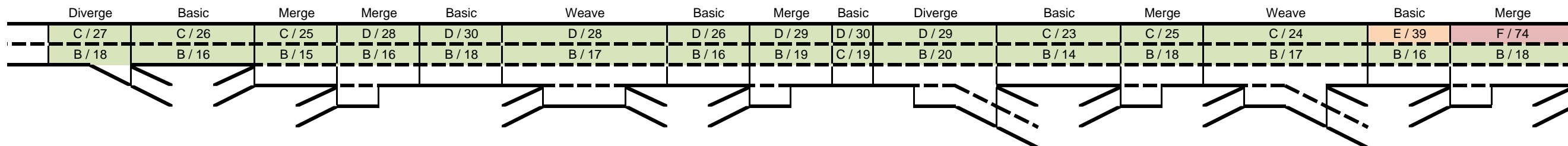

Legend:
 LOS A - D (Green)
 LOS E (Orange)
 LOS F (Red)
 Interchange (Box)
 <> HOV Lane
 Facility Type (Basic, Merge, Diverge, or Weave)
 AM Peak Hour LOS / Density
 PM Peak Hour LOS / Density
 F / 90 (Red) Project Impact

Southbound SR 65



Alternative 1 - Carpool Lane

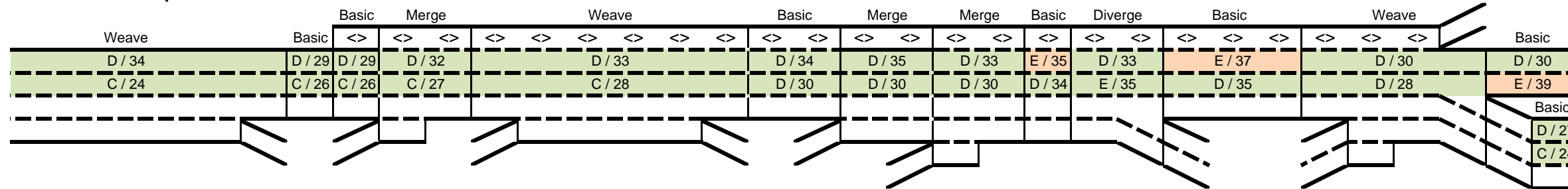

Alternative 2 - General Purpose Lane

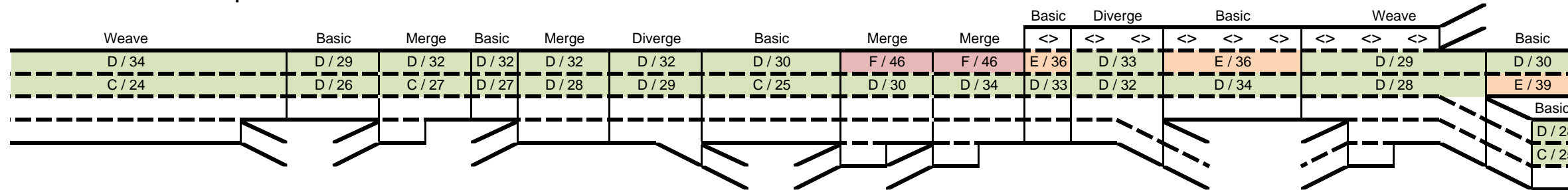

Alternative 3 - No Build

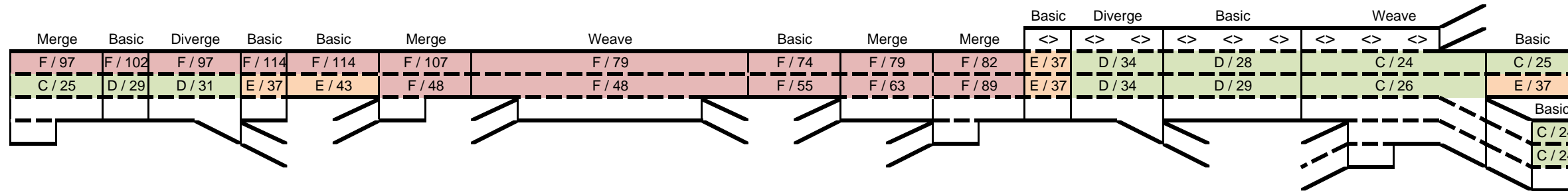

Legend:

- LOS A - D (Green)
- LOS E (Orange)
- LOS F (Red)
- Interchange (Box)
- HOV Lane (Chevron)
- Facility Type (Basic, Merge, Diverge, or Weave)
- AM Peak Hour LOS / Density
- PM Peak Hour LOS / Density
- F / 90 (Red text) Project Impact

Eastbound I-80



Alternative 1 - Carpool Lane

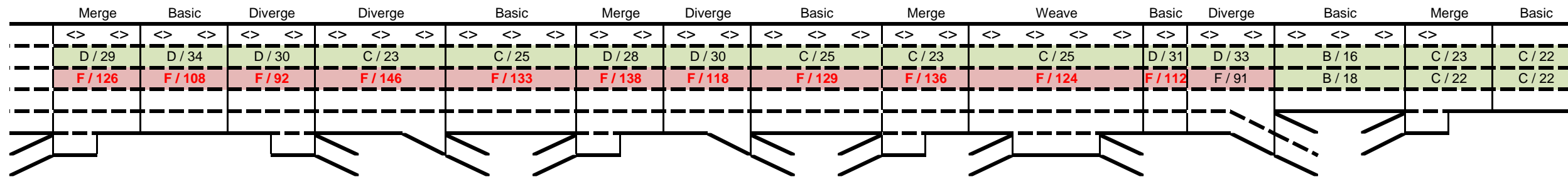

Alternative 2 - General Purpose Lane

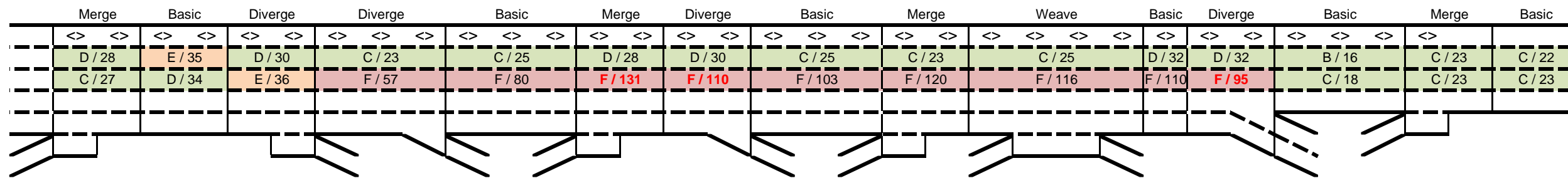

Alternative 3 - No Build

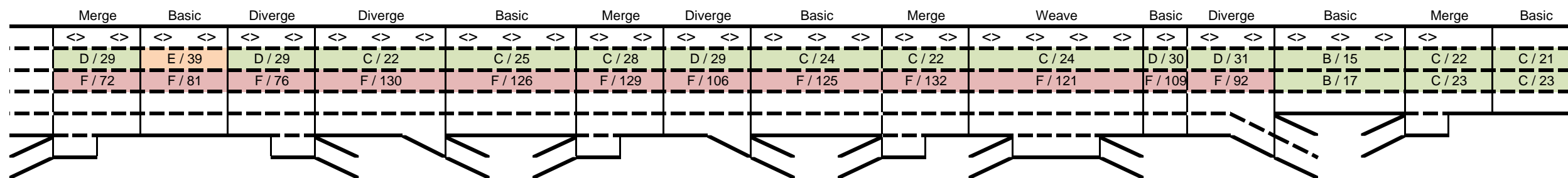

Legend:

- LOS A - D (Green)
- LOS E (Orange)
- LOS F (Red)
- Interchange (Boxed text)
- HOV Lane (Double arrow symbol)
- Facility Type (Basic, Merge, Diverge, or Weave)
- AM Peak Hour LOS / Density
- PM Peak Hour LOS / Density
- F / 90 (Red text)
- Project Impact (Text)

Eastbound I-80



Alternative 1 - Carpool Lane

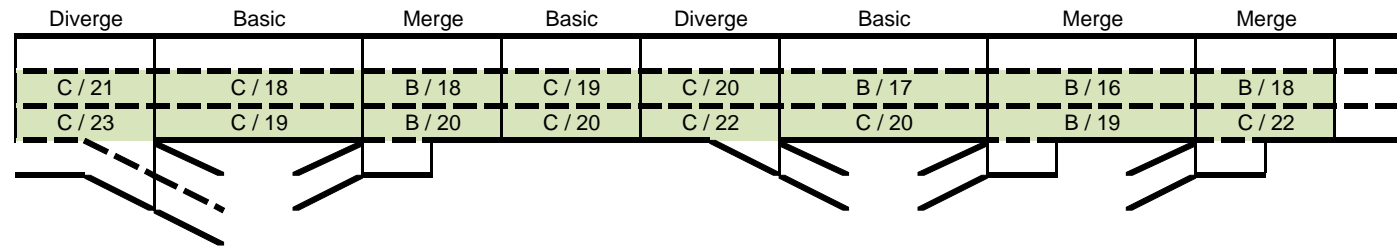

Alternative 2 - General Purpose Lane

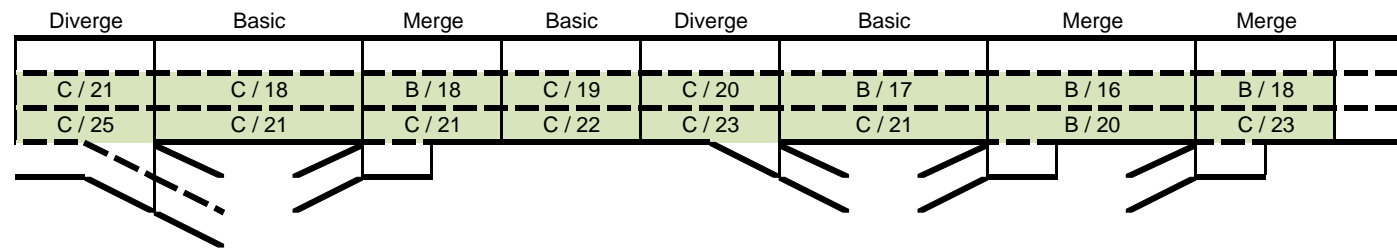

Alternative 3 - No Build

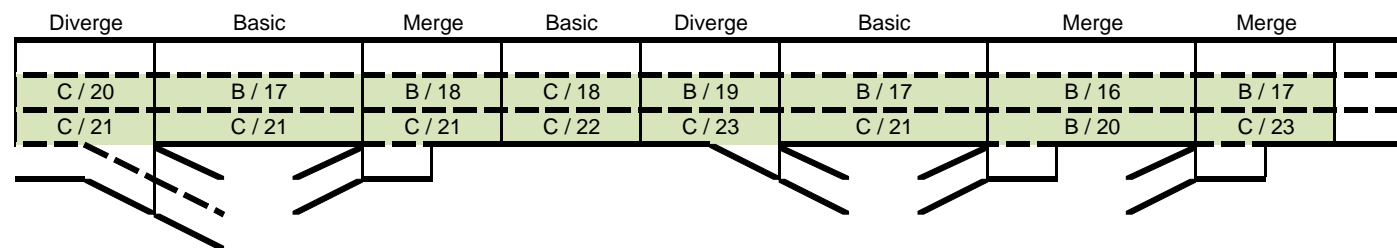

Legend:
 LOS A - D
 LOS E
 LOS F
Interchange
 <> HOV Lane
 Facility Type (Basic, Merge, Diverge, or Weave)
 AM Peak Hour LOS / Density
 PM Peak Hour LOS / Density
F / 90 Project Impact

Westbound I-80

Sierra College Blvd

Rocklin Rd

SR 65 / Taylor Rd

Atlantic St

Alternative 1 - Carpool Lane

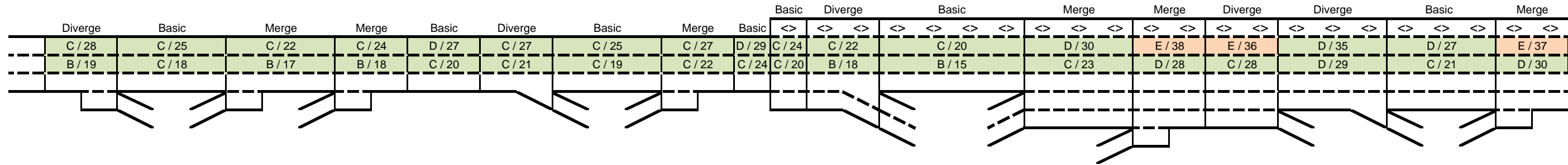

Alternative 2 - General Purpose Lane

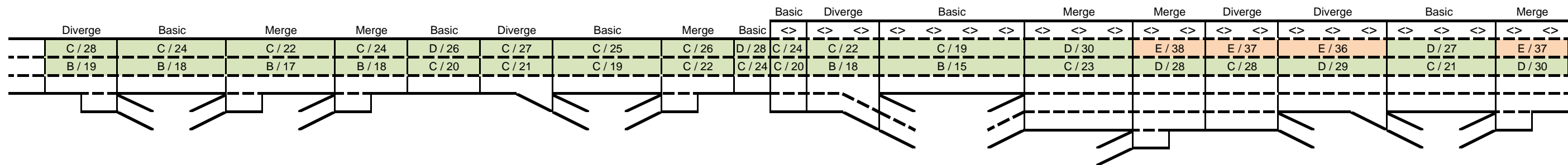

Alternative 3 - No Build

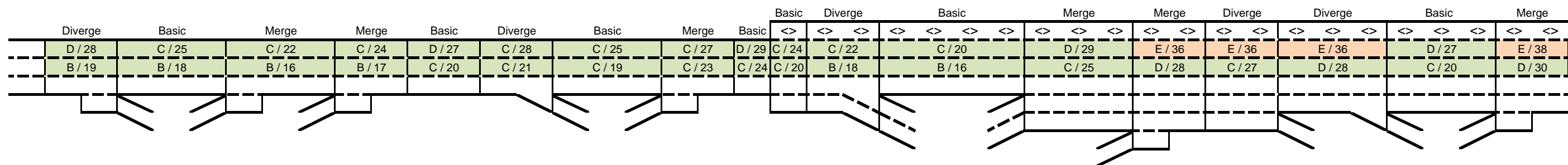

Legend:
 LOS A - D (Green)
 LOS E (Orange)
 LOS F (Red)
 Interchange (Box)
 <> HOV Lane
 Facility Type (Basic, Merge, Diverge, or Weave)
 AM Peak Hour LOS / Density
 PM Peak Hour LOS / Density
 F / 90 Project Impact

Westbound I-80



Alternative 1 - Carpool Lane

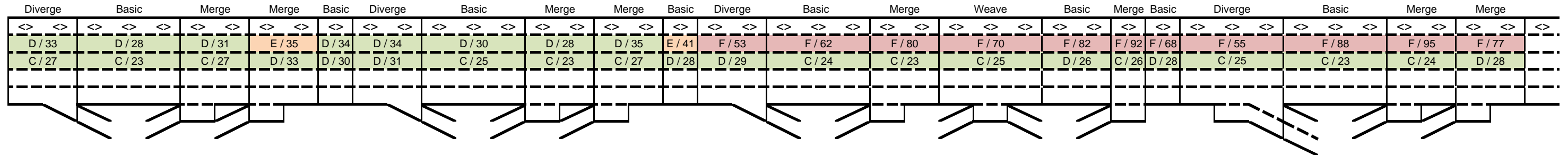

Alternative 2 - General Purpose Lane

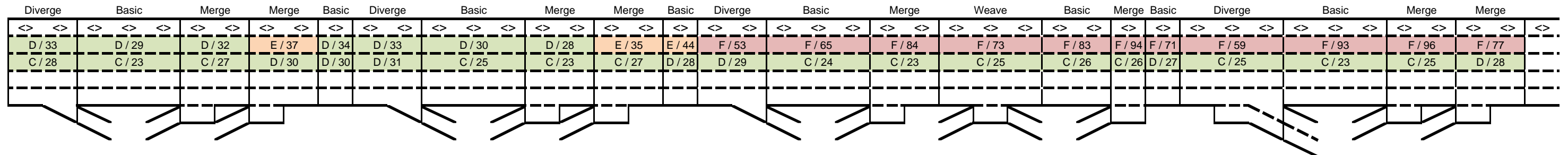

Alternative 3 - No Build

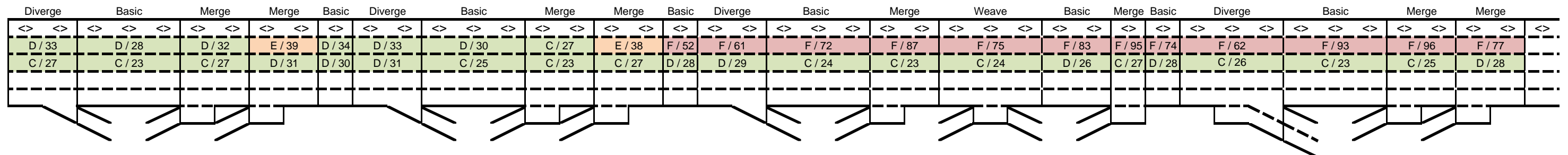

Legend:

- LOS A - D
- LOS E
- LOS F
- Interchange
- HOV Lane
- F / 90 Project Impact

Facility Type (Basic, Merge, Diverge, or Weave)

Northbound SR 65



Alternative 1 - Carpool Lane

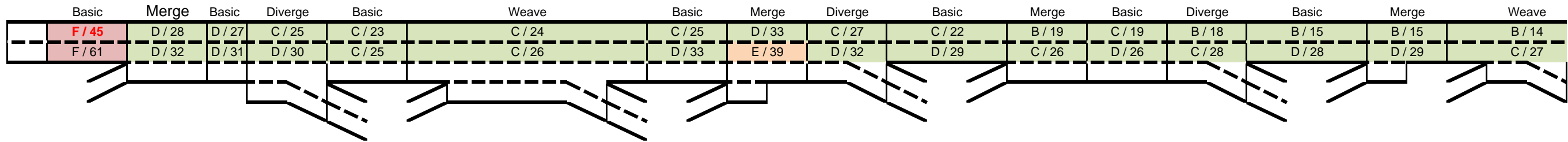

Alternative 2 - General Purpose Lane

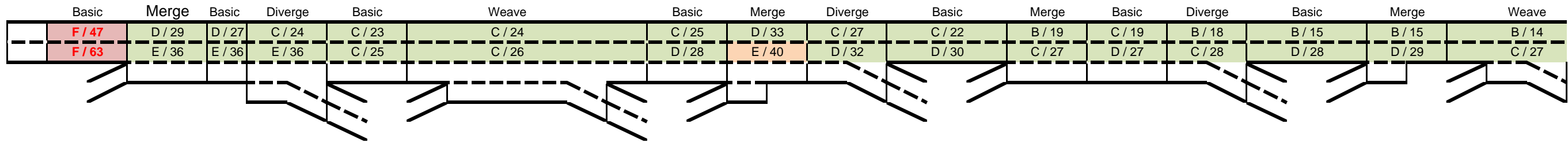

Alternative 3 - No Build

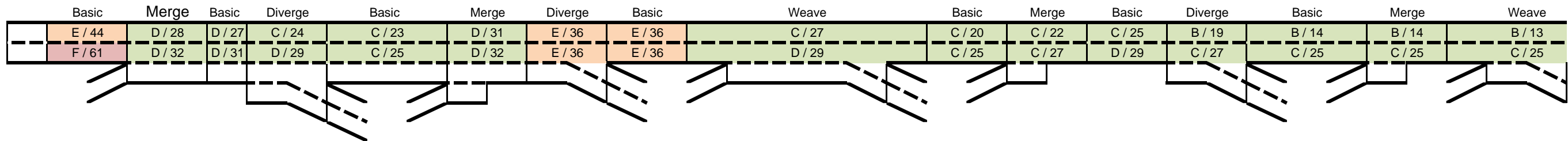

Legend:
 LOS A - D (Green)
 LOS E (Orange)
 LOS F (Red)
 Interchange (Box)
 HOV Lane (Arrow)
 Facility Type (Basic, Merge, Diverge, or Weave)
 AM Peak Hour LOS / Density
 PM Peak Hour LOS / Density
 F / 90 (Red) Project Impact

Northbound SR 65



Alternative 1 - Carpool Lane

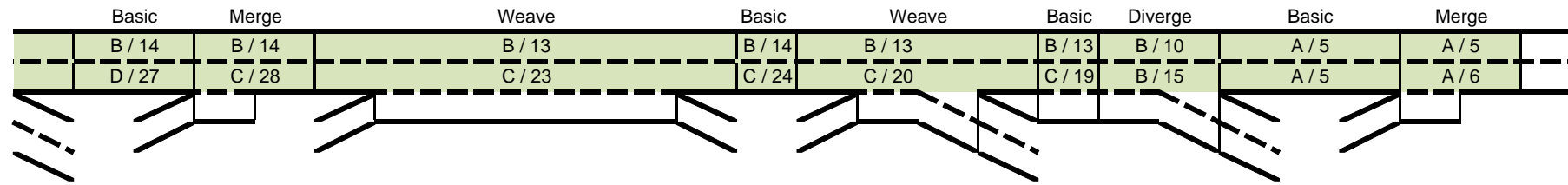

Alternative 2 - General Purpose Lane

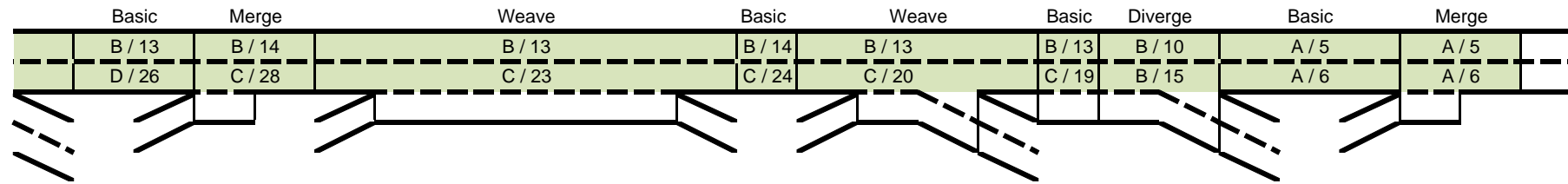

Alternative 3 - No Build

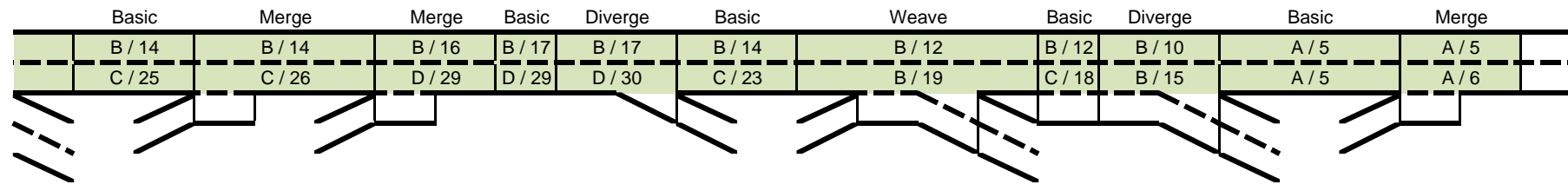

Legend:
 LOS A - D
 LOS E
 LOS F

Interchange AM Peak Hour LOS / Density
 <> HOV Lane PM Peak Hour LOS / Density

Facility Type (Basic, Merge, Diverge, or Weave)

F / 90

Project Impact

Southbound SR 65



Alternative 1 - Carpool Lane

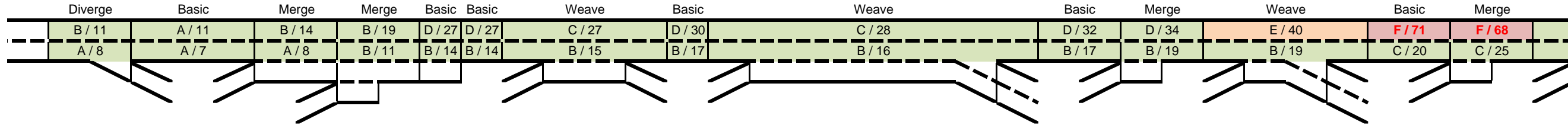

Alternative 2 - General Purpose Lane

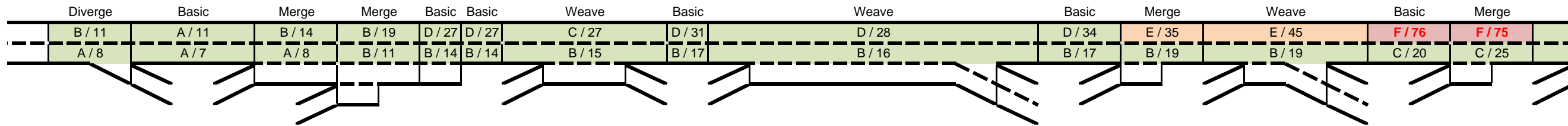

Alternative 3 - No Build

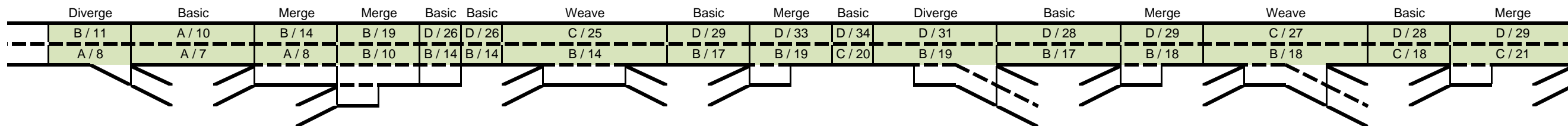

Legend:
 LOS A - D (Green)
 LOS E (Orange)
 LOS F (Red)
 Interchange (Box)
 <-> HOV Lane
 Facility Type (Basic, Merge, Diverge, or Weave)
 AM Peak Hour LOS / Density
 PM Peak Hour LOS / Density
 F / 90 (Red) Project Impact

Southbound SR 65



Alternative 1 - Carpool Lane

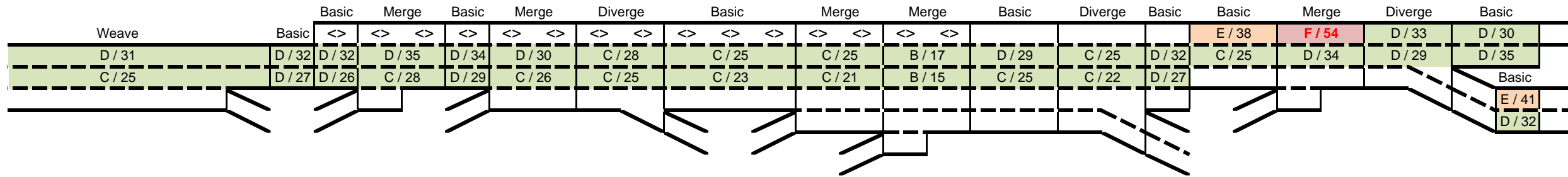

Alternative 2 - General Purpose Lane

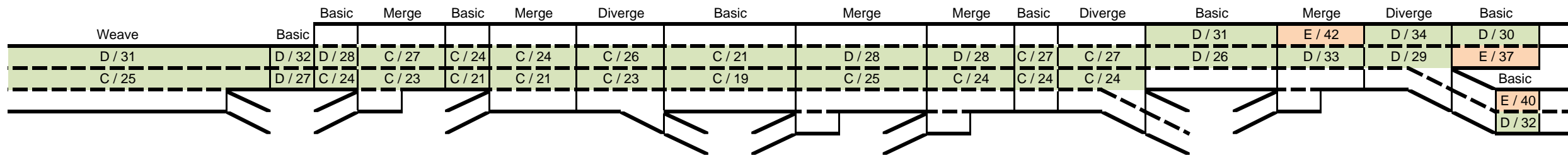

Alternative 3 - No Build

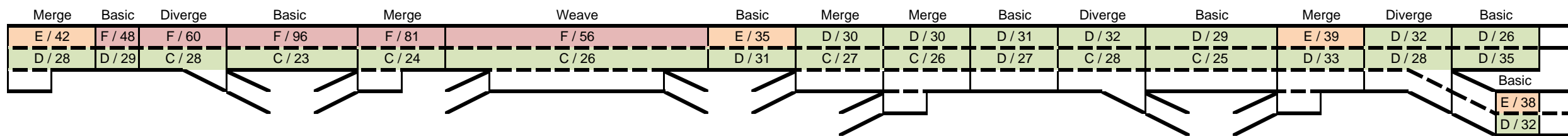

Legend:

- LOS A - D (Green)
- LOS E (Orange)
- LOS F (Red)
- Interchange (Boxed)
- <> HOV Lane
- Facility Type (Basic, Merge, Diverge, or Weave)
- AM Peak Hour LOS / Density
- PM Peak Hour LOS / Density
- F / 90 Project Impact

SR 65 Capacity and Operational Improvements

Intersection Analysis Results Summary Tables

TABLE 8A: INTERSECTION OPERATIONS RESULTS – EXISTING (2012) CONDITIONS

Intersection	Threshold	AM Peak Hour	PM Peak Hour
1. SR 65 / Sterling Pkwy	C	B / 19	B / 18
2. Twelve Bridges Dr / SR 65 SB Ramps	C	A / 4	A / 5
3. Twelve Bridges Dr / SR 65 NB Ramps	C	A / 3	A / 3
4. Sunset Blvd / SR 65 SB Ramps	C	A / 7	A / 6
5. Sunset Blvd / SR 65 NB Ramps	C	A / 10	A / 9
6. Blue Oaks Blvd / Washington Blvd / SR 65 SB Ramps	C	<u>D / 43</u>	C / 33
7. Blue Oaks Blvd / SR 65 NB Ramps	C	C / 24	C / 23
8. Pleasant Grove Blvd / SR 65 NB Ramps	C	A / 9	A / 8
9. Pleasant Grove Blvd / SR 65 SB Ramps	C	B / 10	B / 14
10. Stanford Ranch Rd / Five Star Blvd	C	B / 19	C / 32
11. Stanford Ranch Rd / SR 65 NB Ramps	D	A / 9	B / 15
12. Galleria Blvd / SR 65 SB Ramps	D	B / 13	B / 19
13. Galleria Blvd / Antelope Creek Dr	C	B / 10	C / 24
14. Galleria Blvd / Roseville Pkwy	E	C / 30	D / 36
15. Roseville Pkwy / Creekside Ridge Dr	C	A / 6	B / 17
16. Roseville Pkwy / Taylor Rd	D	C / 30	C / 28
17. Roseville Pkwy / Sunrise Ave	E	D / 37	D / 37
18. Atlantic St / Wills Rd	C	B / 10	B / 12
19. Atlantic St / I-80 WB Ramps	C	A / 7	B / 11
20. Eureka Rd / Taylor Rd / I-80 EB Ramps	E	C / 26	<u>E / 61</u>
21. Eureka Rd / Sunrise Ave	C	C / 24	C / 30
22. Harding Blvd / Wills Rd	C	B / 12	B / 13
23. Douglas Blvd / Harding Blvd	E	B / 19	C / 28
24. Douglas Blvd / I-80 WB Ramps	C	B / 14	B / 17
25. Douglas Blvd / I-80 EB Ramps	C	A / 6	A / 6
26. Douglas Blvd / Sunrise Ave	D	C / 26	D / 35
27. Pacific St / Woodside Dr	C	A / 7	A / 6
28. Pacific St / Sunset Blvd	C	B / 18	C / 29
29. Rocklin Rd / Granite Dr	C	B / 15	<u>D / 37</u>
30. Rocklin Rd / I-80 WB Ramps	C	C / 21	B / 17
31. Rocklin Rd / I-80 EB Ramps	C	B / 17	B / 20
32. Rocklin Rd / Aguilar Rd	C	A / 8	B / 13
Notes: Bold and underline font indicate unacceptable operations. The LOS and average delay in seconds per vehicle are reported.			
Source: Fehr & Peers, 2015			

**TABLE 18A: INTERSECTION OPERATIONS RESULTS –
DESIGN YEAR AM PEAK HOUR CONDITIONS**

Intersection	Threshold	Alternative 1	Alternative 2	Alternative 3
1. Lincoln Blvd / Sterling Pkwy	C	B / 15	B / 14	B / 15
2. Twelve Bridges Dr / SR 65 SB Ramps	C	B / 15	B / 16	B / 16
3. Twelve Bridges Dr / SR 65 NB Ramps	C	C / 22	C / 23	C / 29
4. Sunset Blvd / SR 65 SB Ramps	C	C / 32	C / 27	B / 17
5. Sunset Blvd / SR 65 NB Ramps	C	B / 12	B / 12	B / 14
6. Blue Oaks Blvd / Washington Blvd / SR 65 SB Ramps	C	<u>E / 57</u>	<u>E / 59</u>	<u>F / 90</u>
7. Blue Oaks Blvd / SR 65 NB Ramps	C	B / 17	B / 16	B / 17
8. Pleasant Grove Blvd / SR 65 SB Ramps	C	A / 9	A / 8	B / 17
9. Pleasant Grove Blvd / SR 65 NB Ramps	C	B / 16	B / 16	B / 14
10. Stanford Ranch Rd / Five Star Blvd	C	C / 27	C / 26	C / 26
11. Stanford Ranch Rd / SR 65 NB Ramps	D	B / 11	B / 12	B / 19
12. Galleria Blvd / SR 65 SB Ramps	D	B / 19	B / 17	D / 55
13. Galleria Blvd / Antelope Creek Dr	C	A / 10	A / 10	A / 8
14. Galleria Blvd / Roseville Pkwy	E	D / 47	D / 45	D / 41
15. Roseville Pkwy / Creekside Ridge Dr	C	A / 8	A / 8	A / 8
16. Roseville Pkwy / Taylor Rd	D	<u>E / 70</u>	<u>E / 66</u>	<u>E / 60</u>
17. Roseville Pkwy / Sunrise Ave	E	C / 33	C / 35	C / 33
18. Atlantic St / Wills Rd	C	C / 23	C / 21	B / 19
19. Atlantic St / I-80 WB Ramps	C	B / 11	B / 14	C / 30
20. Eureka Rd / Taylor Rd / I-80 EB Ramps	E	C / 30	C / 30	C / 30
21. Eureka Rd / Sunrise Ave	C	<u>D / 41</u>	<u>D / 41</u>	<u>D / 41</u>
22. Harding Blvd / Wills Rd	C	B / 16	B / 15	B / 15
23. Douglas Blvd / Harding Blvd	E	C / 26	C / 28	C / 26
24. Douglas Blvd / I-80 WB Ramps	C	C / 21	B / 19	C / 22
25. Douglas Blvd / I-80 EB Ramps	C	C / 28	C / 24	C / 29
26. Douglas Blvd / Sunrise Ave	D	D / 54	D / 44	D / 43
27. Pacific St / Woodside Dr	C	A / 8	A / 8	A / 8
28. Pacific St / Sunset Blvd	C	C / 26	C / 26	C / 29
29. Rocklin Rd / Granite Dr	C	C / 29	C / 28	C / 26
30. Rocklin Rd / I-80 WB Ramps	C	C / 23	C / 24	C / 22
31. Rocklin Rd / I-80 EB Ramps	C	C / 30	C / 26	<u>D / 41</u>
32. Rocklin Rd / Aguilar Rd	C	A / 10	A / 10	A / 9

**TABLE 18A: INTERSECTION OPERATIONS RESULTS –
DESIGN YEAR AM PEAK HOUR CONDITIONS**

Intersection	Threshold	Alternative 1	Alternative 2	Alternative 3
33. Lincoln Blvd / SR 65 NB Off-ramp	C	A / 10	A / 9	A / 10
34. Lincoln Blvd / SR 65 SB On-ramp	C	C / 22	C / 20	B / 17
35. Placer Pkwy / SR 65 SB Ramps	C	C / 24	B / 20	B / 19
36. Whitney Ranch Pkwy / SR 65 NB Ramps	C	B / 16	B / 15	B / 14

Note: Bold and underline font indicate unacceptable operations. Shaded cells indicate a project impact. The LOS and average delay in seconds per vehicle are reported.

Source: Fehr & Peers, 2015

TABLE 19A: INTERSECTION OPERATIONS RESULTS – DESIGN YEAR PM PEAK HOUR CONDITIONS				
Intersection	Threshold	Alternative 1	Alternative 2	Alternative 3
1. Lincoln Blvd / Sterling Pkwy	C	C / 23	B / 17	C / 20
2. Twelve Bridges Dr / SR 65 SB Ramps	C	C / 27	C / 28	B / 16
3. Twelve Bridges Dr / SR 65 NB Ramps	C	C / 20	B / 20	C / 22
4. Sunset Blvd / SR 65 SB Ramps	C	A / 10	B / 15	B / 17
5. Sunset Blvd / SR 65 NB Ramps	C	B / 16	B / 11	B / 14
6. Blue Oaks Blvd / Washington Blvd / SR 65 SB Ramps	C	<u>F / 140</u>	<u>F / 153</u>	<u>F / 214</u>
7. Blue Oaks Blvd / SR 65 NB Ramps	C	<u>D / 45</u>	<u>D / 49</u>	<u>F / 94</u>
8. Pleasant Grove Blvd / SR 65 SB Ramps	C	A / 9	A / 8	C / 30
9. Pleasant Grove Blvd / SR 65 NB Ramps	C	B / 15	B / 14	B / 13
10. Stanford Ranch Rd / Five Star Blvd	C	<u>F / 82</u>	<u>E / 57</u>	<u>F / 85</u>
11. Stanford Ranch Rd / SR 65 NB Ramps	D	D / 36	B / 19	C / 21
12. Galleria Blvd / SR 65 SB Ramps	D	C / 25	B / 19	C / 27
13. Galleria Blvd / Antelope Creek Dr	C	C / 28	C / 29	C / 28
14. Galleria Blvd / Roseville Pkwy	E	<u>F / 93</u>	<u>F / 82</u>	<u>F / 93</u>
15. Roseville Pkwy / Creekside Ridge Dr	C	<u>D / 50</u>	<u>D / 47</u>	<u>D / 50</u>
16. Roseville Pkwy / Taylor Rd	D	D / 52	D / 52	<u>E / 55</u>
17. Roseville Pkwy / Sunrise Ave	E	E / 70	E / 57	<u>F / 89</u>
18. Atlantic St / Wills Rd	C	C / 24	C / 25	C / 30
19. Atlantic St / I-80 WB Ramps	C	B / 13	C / 24	C / 22
20. Eureka Rd / Taylor Rd / I-80 EB Ramps	E	E / 75	<u>F / 81</u>	<u>F / 99</u>
21. Eureka Rd / Sunrise Ave	C	<u>F / 94</u>	<u>F / 103</u>	<u>F / 104</u>
22. Harding Blvd / Wills Rd	C	B / 17	B / 16	B / 19
23. Douglas Blvd / Harding Blvd	E	<u>F / 91</u>	<u>F / 96</u>	E / 69
24. Douglas Blvd / I-80 WB Ramps	C	C / 28	C / 33	C / 20
25. Douglas Blvd / I-80 EB Ramps	C	<u>D / 37</u>	<u>D / 37</u>	<u>D / 39</u>
26. Douglas Blvd / Sunrise Ave	D	<u>F / 254</u>	<u>F / 241</u>	<u>F / 239</u>
27. Pacific St / Woodside Dr	C	A / 10	B / 11	A / 10
28. Pacific St / Sunset Blvd	C	C / 33	<u>D / 37</u>	<u>D / 37</u>
29. Rocklin Rd / Granite Dr	C	<u>F / 95</u>	<u>F / 84</u>	<u>F / 101</u>
30. Rocklin Rd / I-80 WB Ramps	C	<u>E / 68</u>	<u>E / 63</u>	<u>D / 54</u>
31. Rocklin Rd / I-80 EB Ramps	C	C / 21	B / 20	C / 21
32. Rocklin Rd / Aguilar Rd	C	C / 32	C / 31	C / 28
33. Lincoln Blvd / SR 65 NB Off-ramp	C	B / 12	B / 10	A / 8

TABLE 19A: INTERSECTION OPERATIONS RESULTS – DESIGN YEAR PM PEAK HOUR CONDITIONS

Intersection	Threshold	Alternative 1	Alternative 2	Alternative 3
34. Lincoln Blvd / SR 65 SB On-ramp	C	B / 17	B / 17	B / 15
35. Placer Pkwy / SR 65 SB Ramps	C	B / 19	C / 22	C / 24
36. Whitney Ranch Pkwy / SR 65 NB Ramps	C	C / 22	C / 21	C / 24

Note: Bold and underline font indicate unacceptable operations. Shaded cells indicate a project impact. The LOS and average delay in seconds per vehicle are reported.

Source: Fehr & Peers, 2015

**TABLE 20A: MAXIMUM QUEUE LENGTH RESULTS –
DESIGN YEAR AM PEAK HOUR CONDITIONS**

Off-ramp	Storage	Alternative 1	Alternative 2
Eastbound I-80 at Eastbound Douglas Blvd	1,400	50	25
Eastbound I-80 at Westbound Douglas Blvd	1,250	100	125
Eastbound I-80 at Eureka Rd	1,700	700	500
Eastbound I-80 at Rocklin Rd	1,080	325	300
Westbound I-80 at Rocklin Rd	1,230	175	200
Westbound I-80 at Westbound Atlantic St	1,430	25	25
Westbound I-80 at Eastbound Atlantic St	1,150	50	75
Westbound I-80 at Douglas Blvd	1,530	400	450
Northbound SR 65 at Northbound Stanford Ranch Rd	1,170	200	200
Northbound SR 65 at Southbound Stanford Ranch Rd	1,800	25	25
Northbound SR 65 at Pleasant Grove Blvd	1,420	200	200
Northbound SR 65 at Blue Oaks Blvd	1,100	325	300
Northbound SR 65 at Sunset Blvd	1,400	225	250
Northbound SR 65 at Whitney Ranch Pkwy	1,620	300	325
Northbound SR 65 at Twelve Bridges Dr	1,500	200	175
Northbound SR 65 at Lincoln Blvd	1,940	200	175
Southbound SR 65 at Twelve Bridges Dr	1,500	250	275
Southbound SR 65 at Placer Pkwy	1,650	975	825
Southbound SR 65 at Sunset Blvd	1,330	275	275
Southbound SR 65 at Blue Oaks Blvd	2,260	1,425	975
Southbound SR 65 at Pleasant Grove Blvd	1,130	200	175
Southbound SR 65 at Southbound Galleria Blvd	1,130	375	400
Southbound SR 65 at Northbound Galleria Blvd	1,780	50	50

Note: Bold and underline font indicate queues that exceed the ramp length. Shaded cells indicate a project impact. The reported value is the average maximum peak-hour queue length in feet.

Source: Fehr & Peers, 2015

**TABLE 21A: MAXIMUM QUEUE LENGTH RESULTS –
DESIGN YEAR PM PEAK HOUR CONDITIONS**

Off-ramp	Storage	Alternative 1	Alternative 2
Eastbound I-80 at Eastbound Douglas Blvd	1,400	1,150	1,175
Eastbound I-80 at Westbound Douglas Blvd	1,250	175	225
Eastbound I-80 at Eureka Rd	1,700	350	400
Eastbound I-80 at Rocklin Rd	1,080	325	300
Westbound I-80 at Rocklin Rd	1,230	450	375
Westbound I-80 at Westbound Atlantic St	1,430	50	25
Westbound I-80 at Eastbound Atlantic St	1,150	250	400
Westbound I-80 at Douglas Blvd	1,530	525	550
Northbound SR 65 at Northbound Stanford Ranch Rd	1,170	475	325
Northbound SR 65 at Southbound Stanford Ranch Rd	1,800	25	25
Northbound SR 65 at Pleasant Grove Blvd	1,420	225	200
Northbound SR 65 at Blue Oaks Blvd	1,100	250	275
Northbound SR 65 at Sunset Blvd	1,400	250	250
Northbound SR 65 at Whitney Ranch Pkwy	1,620	500	500
Northbound SR 65 at Twelve Bridges Dr	1,500	125	100
Northbound SR 65 at Lincoln Blvd	1,940	425	375
Southbound SR 65 at Twelve Bridges Dr	1,500	225	225
Southbound SR 65 at Placer Pkwy	1,650	375	350
Southbound SR 65 at Sunset Blvd	1,330	225	225
Southbound SR 65 at Blue Oaks Blvd	2,260	900	850
Southbound SR 65 at Pleasant Grove Blvd	1,130	150	150
Southbound SR 65 at Southbound Galleria Blvd	1,130	400	400
Southbound SR 65 at Northbound Galleria Blvd	1,780	325	175

Note: Bold and underline font indicate queues that exceed the ramp length. Shaded cells indicate a project impact. The reported value is the average maximum peak-hour queue length in feet.

Source: Fehr & Peers, 2015

**TABLE 26A: INTERSECTION OPERATIONS RESULTS –
CONSTRUCTION YEAR AM PEAK HOUR CONDITIONS**

Intersection	Threshold	Alternative 1	Alternative 2	Alternative 3
1. Lincoln Blvd / Sterling Pkwy	C	B / 11	B / 11	A / 10
2. Twelve Bridges Dr / SR 65 SB Ramps	C	B / 10	B / 10	A / 9
3. Twelve Bridges Dr / SR 65 NB Ramps	C	A / 9	A / 9	A / 9
4. Sunset Blvd / SR 65 SB Ramps	C	B / 11	B / 12	B / 10
5. Sunset Blvd / SR 65 NB Ramps	C	B / 13	B / 13	B / 15
6. Blue Oaks Blvd / Washington Blvd / SR 65 SB Ramps	C	C / 31	C / 35	<u>D / 52</u>
7. Blue Oaks Blvd / SR 65 NB Ramps	C	B / 12	B / 15	B / 13
8. Pleasant Grove Blvd / SR 65 SB Ramps	C	A / 7	A / 7	A / 6
9. Pleasant Grove Blvd / SR 65 NB Ramps	C	B / 14	B / 14	B / 11
10. Stanford Ranch Rd / Five Star Blvd	C	C / 27	C / 27	C / 29
11. Stanford Ranch Rd / SR 65 NB Ramps	D	B / 15	B / 20	B / 18
12. Galleria Blvd / SR 65 SB Ramps	D	B / 17	B / 17	B / 17
13. Galleria Blvd / Antelope Creek Dr	C	B / 14	B / 13	B / 14
14. Galleria Blvd / Roseville Pkwy	E	D / 41	D / 42	D / 37
15. Roseville Pkwy / Creekside Ridge Dr	C	A / 8	A / 8	B / 11
16. Roseville Pkwy / Taylor Rd	D	D / 49	D / 46	<u>F / 133</u>
17. Roseville Pkwy / Sunrise Ave	E	C / 28	C / 28	C / 23
18. Atlantic St / Wills Rd	C	C / 24	C / 24	B / 19
19. Atlantic St / I-80 WB Ramps	C	B / 15	B / 14	B / 11
20. Eureka Rd / Taylor Rd / I-80 EB Ramps	E	C / 25	C / 25	C / 22
21. Eureka Rd / Sunrise Ave	C	C / 32	C / 33	C / 26
22. Harding Blvd / Wills Rd	C	C / 23	C / 25	B / 14
23. Douglas Blvd / Harding Blvd	E	D / 51	C / 30	D / 36
24. Douglas Blvd / I-80 WB Ramps	C	C / 23	C / 24	B / 20
25. Douglas Blvd / I-80 EB Ramps	C	B / 20	A / 10	B / 12
26. Douglas Blvd / Sunrise Ave	D	C / 33	C / 33	C / 28
27. Pacific St / Woodside Dr	C	A / 7	A / 7	A / 9
28. Pacific St / Sunset Blvd	C	C / 24	C / 24	C / 27
29. Rocklin Rd / Granite Dr	C	B / 17	B / 18	B / 19
30. Rocklin Rd / I-80 WB Ramps	C	C / 23	C / 29	C / 21
31. Rocklin Rd / I-80 EB Ramps	C	D / 42	D / 49	<u>D / 37</u>
32. Rocklin Rd / Aguilar Rd	C	B / 14	C / 20	C / 23

**TABLE 26A: INTERSECTION OPERATIONS RESULTS –
CONSTRUCTION YEAR AM PEAK HOUR CONDITIONS**

Intersection	Threshold	Alternative 1	Alternative 2	Alternative 3
33. Lincoln Blvd / SR 65 NB Off-ramp	C	A / 6	A / 6	A / 6
34. Lincoln Blvd / SR 65 SB On-ramp	C	C / 21	C / 22	C / 20
35. Placer Pkwy / SR 65 SB Ramps	C	A / 9	A / 8	A / 9
36. Whitney Ranch Pkwy / SR 65 NB Ramps	C	A / 9	A / 9	B / 11

Note: Bold and underline font indicate unacceptable operations. Shaded cells indicate a project impact. The LOS and average delay in seconds per vehicle are reported.

Source: Fehr & Peers, 2015

**TABLE 27A: INTERSECTION OPERATIONS RESULTS –
CONSTRUCTION YEAR PM PEAK HOUR CONDITIONS**

Intersection	Threshold	Alternative 1	Alternative 2	Alternative 3
1. Lincoln Blvd / Sterling Pkwy	C	A / 9	A / 10	A / 8
2. Twelve Bridges Dr / SR 65 SB Ramps	C	B / 12	B / 12	A / 7
3. Twelve Bridges Dr / SR 65 NB Ramps	C	B / 11	B / 11	A / 9
4. Sunset Blvd / SR 65 SB Ramps	C	A / 6	A / 6	B / 12
5. Sunset Blvd / SR 65 NB Ramps	C	B / 13	B / 14	B / 17
6. Blue Oaks Blvd / Washington Blvd / SR 65 SB Ramps	C	<u>D / 47</u>	<u>D / 44</u>	<u>F / 126</u>
7. Blue Oaks Blvd / SR 65 NB Ramps	C	B / 15	B / 18	<u>E / 70</u>
8. Pleasant Grove Blvd / SR 65 SB Ramps	C	C / 31	C / 29	A / 7
9. Pleasant Grove Blvd / SR 65 NB Ramps	C	C / 24	C / 33	B / 12
10. Stanford Ranch Rd / Five Star Blvd	C	<u>F / 92</u>	<u>E / 76</u>	<u>D / 48</u>
11. Stanford Ranch Rd / SR 65 NB Ramps	D	C / 23	C / 25	B / 12
12. Galleria Blvd / SR 65 SB Ramps	D	B / 16	B / 17	B / 16
13. Galleria Blvd / Antelope Creek Dr	C	C / 23	C / 25	C / 24
14. Galleria Blvd / Roseville Pkwy	E	E / 61	E / 62	E / 58
15. Roseville Pkwy / Creekside Ridge Dr	C	C / 34	C / 32	C / 26
16. Roseville Pkwy / Taylor Rd	D	D / 51	D / 53	D / 42
17. Roseville Pkwy / Sunrise Ave	E	D / 42	D / 41	C / 30
18. Atlantic St / Wills Rd	C	<u>D / 39</u>	<u>D / 36</u>	C / 22
19. Atlantic St / I-80 WB Ramps	C	B / 13	B / 12	B / 12
20. Eureka Rd / Taylor Rd / I-80 EB Ramps	E	D / 52	E / 72	D / 41
21. Eureka Rd / Sunrise Ave	C	<u>D / 44</u>	<u>D / 44</u>	<u>E / 62</u>
22. Harding Blvd / Wills Rd	C	C / 26	C / 26	B / 19
23. Douglas Blvd / Harding Blvd	E	E / 77	<u>F / 128</u>	<u>F / 92</u>
24. Douglas Blvd / I-80 WB Ramps	C	C / 35	C / 31	C / 31
25. Douglas Blvd / I-80 EB Ramps	C	<u>D / 41</u>	<u>D / 35</u>	C / 29
26. Douglas Blvd / Sunrise Ave	D	D / 54	<u>F / 86</u>	D / 39
27. Pacific St / Woodside Dr	C	A / 7	A / 7	A / 9
28. Pacific St / Sunset Blvd	C	C / 30	C / 29	<u>F / 86</u>
29. Rocklin Rd / Granite Dr	C	<u>F / 130</u>	<u>F / 130</u>	<u>F / 127</u>
30. Rocklin Rd / I-80 WB Ramps	C	C / 27	C / 25	<u>D / 38</u>
31. Rocklin Rd / I-80 EB Ramps	C	<u>E / 57</u>	<u>D / 46</u>	C / 33
32. Rocklin Rd / Aguilar Rd	C	C / 23	C / 23	C / 30

**TABLE 27A: INTERSECTION OPERATIONS RESULTS –
CONSTRUCTION YEAR PM PEAK HOUR CONDITIONS**

Intersection	Threshold	Alternative 1	Alternative 2	Alternative 3
33. Lincoln Blvd / SR 65 NB Off-ramp	C	A / 9	A / 9	A / 8
34. Lincoln Blvd / SR 65 SB On-ramp	C	C / 23	C / 22	C / 21
35. Placer Pkwy / SR 65 SB Ramps	C	A / 9	A / 9	A / 9
36. Whitney Ranch Pkwy / SR 65 NB Ramps	C	C / 32	C / 27	C / 23

Note: Bold and underline font indicate unacceptable operations. Shaded cells indicate a project impact. The LOS and average delay in seconds per vehicle are reported.

Source: Fehr & Peers, 2015

**TABLE 28A: MAXIMUM QUEUE LENGTH RESULTS –
CONSTRUCTION YEAR AM PEAK HOUR CONDITIONS**

Off-ramp	Storage	Alternative 1	Alternative 2
Eastbound I-80 at Eastbound Douglas Blvd	1,400	25	25
Eastbound I-80 at Westbound Douglas Blvd	1,250	125	125
Eastbound I-80 at Eureka Rd	1,700	500	400
Eastbound I-80 at Rocklin Rd	1,080	300	350
Westbound I-80 at Rocklin Rd	1,230	125	125
Westbound I-80 at Westbound Atlantic St	1,430	25	25
Westbound I-80 at Eastbound Atlantic St	1,150	25	25
Westbound I-80 at Douglas Blvd	1,530	350	350
Northbound SR 65 at Northbound Stanford Ranch Rd	1,170	125	100
Northbound SR 65 at Southbound Stanford Ranch Rd	1,800	25	25
Northbound SR 65 at Pleasant Grove Blvd	1,420	150	150
Northbound SR 65 at Blue Oaks Blvd	1,100	600	650
Northbound SR 65 at Sunset Blvd	1,400	275	275
Northbound SR 65 at Whitney Ranch Pkwy	1,620	150	150
Northbound SR 65 at Twelve Bridges Dr	1,500	75	75
Northbound SR 65 at Lincoln Blvd	1,940	25	25
Southbound SR 65 at Twelve Bridges Dr	1,500	125	125
Southbound SR 65 at Placer Pkwy	1,650	200	200
Southbound SR 65 at Sunset Blvd	1,330	200	200
Southbound SR 65 at Blue Oaks Blvd	2,260	350	350
Southbound SR 65 at Pleasant Grove Blvd	1,130	175	150
Southbound SR 65 at Southbound Galleria Blvd	1,130	275	275
Southbound SR 65 at Northbound Galleria Blvd	1,780	50	50

Note: Bold and underline font indicate queues that exceed the ramp length. Shaded cells indicate a project impact. The reported value is the average maximum peak-hour queue length in feet.

Source: Fehr & Peers, 2015

**TABLE 29A: MAXIMUM QUEUE LENGTH RESULTS –
CONSTRUCTION YEAR PM PEAK HOUR CONDITIONS**

Off-ramp	Storage	Alternative 1	Alternative 2
Eastbound I-80 at Eastbound Douglas Blvd	1,400	50	25
Eastbound I-80 at Westbound Douglas Blvd	1,250	1,100	950
Eastbound I-80 at Eureka Rd	1,700	1,125	1,675
Eastbound I-80 at Rocklin Rd	1,080	925	700
Westbound I-80 at Rocklin Rd	1,230	200	175
Westbound I-80 at Westbound Atlantic St	1,430	50	25
Westbound I-80 at Eastbound Atlantic St	1,150	25	25
Westbound I-80 at Douglas Blvd	1,530	325	300
Northbound SR 65 at Northbound Stanford Ranch Rd	1,170	350	400
Northbound SR 65 at Southbound Stanford Ranch Rd	1,800	25	50
Northbound SR 65 at Pleasant Grove Blvd	1,420	200	250
Northbound SR 65 at Blue Oaks Blvd	1,100	525	925
Northbound SR 65 at Sunset Blvd	1,400	225	225
Northbound SR 65 at Whitney Ranch Pkwy	1,620	200	225
Northbound SR 65 at Twelve Bridges Dr	1,500	100	100
Northbound SR 65 at Lincoln Blvd	1,940	25	25
Southbound SR 65 at Twelve Bridges Dr	1,500	100	100
Southbound SR 65 at Placer Pkwy	1,650	150	175
Southbound SR 65 at Sunset Blvd	1,330	125	150
Southbound SR 65 at Blue Oaks Blvd	2,260	250	250
Southbound SR 65 at Pleasant Grove Blvd	1,130	150	125
Southbound SR 65 at Southbound Galleria Blvd	1,130	250	275
Southbound SR 65 at Northbound Galleria Blvd	1,780	150	175

Note: Bold and underline font indicate queues that exceed the ramp length. Shaded cells indicate a project impact. The reported value is the average maximum peak-hour queue length in feet.

Source: Fehr & Peers, 2015

SR 65 Capacity and Operational Improvements

Ramp Meter Calculations

RAMP METERING ANALYSIS

Project: Stanford Ranch Rd/SR 65 Northbound Ramps
Ramp: Stanford Ranch Road to Northbound SR 65
Scenario: Build Alternative Design Year Conditions

Configuration: 1 metered + 1 HOV
Peak Hour Volume: 720
Peak Period Volume: 2,150

HOV Bypass (%)	14%
Metered Volume (veh/hr)	617
Metering Rate (veh/hr)	655
Discharge Rate (veh/15 min)	164

Storage Length (ft)	615
Storage Lanes	1
Maximum Storage (veh)	21

Time Interval	Hourly Arrival Distribution	15-Minute Volumes	Metered 15-Minute min flows	Excess Demand	Accumulated Vehicles	Total Delay (veh-hr)	Vehicles Delayed	Total Hourly Volume	Metered Hourly Volume
6:00-6:15	19%	80	69	0	0	0.00	0		
6:15-6:30	23%	97	83	0	0	0.00	0		
6:30-6:45	27%	110	94	0	0	0.00	0		
6:45-7:00	31%	127	109	0	0	0.00	0	414	355
7:00-7:15	19%	130	111	0	0	0.00	0	464	398
7:15-7:30	26%	183	157	0	0	0.00	0	550	471
7:30-7:45	26%	181	155	0	0	0.00	0	621	532
7:45-8:00	30%	209	179	15	15	3.83	179	703	602
8:00-8:15	25%	180	154	0	6	1.44	154	753	645
8:15-8:30	28%	204	175	11	17	4.20	175	774	663
8:30-8:45	22%	162	139	0	0	0.00	0	755	647
8:45-9:00	26%	187	160	0	0	0.00	0	733	628
9:00-9:15	26%	182	156	0	0	0.00	0	735	630
9:15-9:30	24%	169	145	0	0	0.00	0	700	600
9:30-9:45	24%	169	145	0	0	0.00	0	707	606
9:45-10:00	25%	176	151	0	0	0.00	0	696	596

Total Delay (veh-hr)	9
Total Vehicles Delayed (veh)	508
Average Delay (hr)	0.02
Average Delay (min)	1.12

Maximum Queue (veh)	17
Maximum Queue (ft)	504

Project: Stanford Ranch Rd/SR 65 Northbound Ramps
Ramp: Stanford Ranch Road to Northbound SR 65
Scenario: Build Alternative Design Year Conditions

Configuration: 1 metered + 1 HOV
Peak Hour Volume: 1,430
Peak Period Volume: 5,270

HOV Bypass (%)	17%
Metered Volume (veh/hr)	1,192
Metering Rate (veh/hr)	900
Discharge Rate (veh/15 min)	225

Storage Length (ft)	615
Storage Lanes	1
Maximum Storage (veh)	21

Time Interval	Hourly Arrival Distribution	15-Minute Volumes	Metered 15-Minute min flows	Excess Demand	Accumulated Vehicles	Total Delay (veh-hr)	Vehicles Delayed	Total Hourly Volume	Metered Hourly Volume
3:00-3:15	24%	336	280	55	55	13.77	280		
3:15-3:30	24%	330	275	50	105	26.28	275		
3:30-3:45	26%	358	298	73	179	44.63	298		
3:45-4:00	26%	364	303	78	257	64.23	303	1388	1157
4:00-4:15	23%	338	282	57	314	78.41	282	1390	1159
4:15-4:30	22%	325	271	46	360	89.89	271	1385	1154
4:30-4:45	27%	397	331	106	465	116.36	331	1424	1187
4:45-5:00	27%	390	325	100	566	141.38	325	1450	1209
5:00-5:15	27%	385	321	96	661	165.36	321	1497	1248
5:15-5:30	25%	349	291	66	727	181.83	291	1521	1268
5:30-5:45	23%	318	265	40	767	191.84	265	1442	1202
5:45-3:00	25%	349	291	66	833	208.32	291	1401	1168
3:00-3:15	23%	302	252	27	860	215.00	252	1318	1099
3:15-3:30	29%	379	316	91	951	237.72	316	1348	1124
3:30-3:45	23%	299	249	24	975	243.78	249	1329	1108
3:45-4:00	24%	308	257	32	1007	251.71	257	1288	1074

Total Delay (veh-hr)	1,322
Total Vehicles Delayed (veh)	3,533
Average Delay (hr)	0.37
Average Delay (min)	22.45

Maximum Queue (veh)	833
Maximum Queue (ft)	24,998

RAMP METERING ANALYSIS

Project: Stanford Ranch Rd/SR 65 Northbound Ramps
Ramp: Stanford Ranch Road to Northbound SR 65
Scenario: Build Alternative Design Year Conditions

Configuration: 2 metered + 1 HOV
Peak Hour Volume: 720
Peak Period Volume: 2,150

HOV Bypass (%)	14%
Metered Volume (veh/hr)	617
Metering Rate (veh/hr)	625
Discharge Rate (veh/15 min)	156

Storage Length (ft)	615
Storage Lanes	2
Maximum Storage (veh)	41

Time Interval	Hourly Arrival Distribution	15-Minute Volumes	Metered 15-Minute min flows	Excess Demand	Accumulated Vehicles	Total Delay (veh-hr)	Vehicles Delayed	Total Hourly Volume	Metered Hourly Volume
6:00-6:15	19%	80	69	0	0	0.00	0		
6:15-6:30	23%	97	83	0	0	0.00	0		
6:30-6:45	27%	110	94	0	0	0.00	0		
6:45-7:00	31%	127	109	0	0	0.00	0	414	355
7:00-7:15	19%	130	111	0	0	0.00	0	464	398
7:15-7:30	26%	183	157	1	1	0.13	157	550	471
7:30-7:45	26%	181	155	0	0	0.00	0	621	532
7:45-8:00	30%	209	179	23	23	5.70	179	703	602
8:00-8:15	25%	180	154	0	21	5.19	154	753	645
8:15-8:30	28%	204	175	19	39	9.83	175	774	663
8:30-8:45	22%	162	139	0	22	5.46	139	755	647
8:45-9:00	26%	187	160	4	26	6.45	160	733	628
9:00-9:15	26%	182	156	0	25	6.37	156	735	630
9:15-9:30	24%	169	145	0	14	3.51	145	700	600
9:30-9:45	24%	169	145	0	3	0.64	145	707	606
9:45-10:00	25%	176	151	0	0	0.00	0	696	596

Total Delay (veh-hr)	43
Total Vehicles Delayed (veh)	1,409
Average Delay (hr)	0.03
Average Delay (min)	1.84

Maximum Queue (veh)	39
Maximum Queue (ft)	590

Project: Stanford Ranch Rd/SR 65 Northbound Ramps
Ramp: Stanford Ranch Road to Northbound SR 65
Scenario: Build Alternative Design Year Conditions

Configuration: 2 metered + 1 HOV
Peak Hour Volume: 1,430
Peak Period Volume: 5,270

HOV Bypass (%)	17%
Metered Volume (veh/hr)	1,192
Metering Rate (veh/hr)	1,250
Discharge Rate (veh/15 min)	313

Storage Length (ft)	615
Storage Lanes	2
Maximum Storage (veh)	41

Time Interval	Hourly Arrival Distribution	15-Minute Volumes	Metered 15-Minute min flows	Excess Demand	Accumulated Vehicles	Total Delay (veh-hr)	Vehicles Delayed	Total Hourly Volume	Metered Hourly Volume
3:00-3:15	24%	336	280	0	0	0.00	0		
3:15-3:30	24%	330	275	0	0	0.00	0		
3:30-3:45	26%	358	298	0	0	0.00	0		
3:45-4:00	26%	364	303	0	0	0.00	0	1388	1157
4:00-4:15	23%	338	282	0	0	0.00	0	1390	1159
4:15-4:30	22%	325	271	0	0	0.00	0	1385	1154
4:30-4:45	27%	397	331	18	18	4.60	331	1424	1187
4:45-5:00	27%	390	325	13	31	7.74	325	1450	1209
5:00-5:15	27%	385	321	8	39	9.85	321	1497	1248
5:15-5:30	25%	349	291	0	18	4.44	291	1521	1268
5:30-5:45	23%	318	265	0	0	0.00	0	1442	1202
5:45-3:00	25%	349	291	0	0	0.00	0	1401	1168
3:00-3:15	23%	302	252	0	0	0.00	0	1318	1099
3:15-3:30	29%	379	316	3	3	0.85	316	1348	1124
3:30-3:45	23%	299	249	0	0	0.00	0	1329	1108
3:45-4:00	24%	308	257	0	0	0.00	0	1288	1074

Total Delay (veh-hr)	27
Total Vehicles Delayed (veh)	1,268
Average Delay (hr)	0.02
Average Delay (min)	1.26

Maximum Queue (veh)	39
Maximum Queue (ft)	591

RAMP METERING ANALYSIS

Project: SR 65 Capacity & Operational Improvements
Ramp: Pleasant Grove Blvd to Northbound SR 65
Scenario: Design Year Conditions

Configuration: 1 metered + 1 HOV
Peak Hour Volume: 290
Peak Period Volume: 870

HOV Bypass (%)	12%
Metered Volume (veh/hr)	255
Metering Rate (veh/hr)	330
Discharge Rate (veh/15 min)	83

Storage Length (ft)	580
Storage Lanes	1
Maximum Storage (veh)	19

Time Interval	Hourly Arrival Distribution	15-Minute Volumes	Metered 15-Minute min flows	Excess Demand	Accumulated Vehicles	Total Delay (veh-hr)	Vehicles Delayed	Total Hourly Volume	Metered Hourly Volume
6:00-6:15	19%	28	25	0	0	0.00	0		
6:15-6:30	23%	34	30	0	0	0.00	0		
6:30-6:45	27%	39	34	0	0	0.00	0		
6:45-7:00	31%	45	40	0	0	0.00	0	146	128
7:00-7:15	19%	37	33	0	0	0.00	0	155	136
7:15-7:30	26%	51	45	0	0	0.00	0	172	151
7:30-7:45	26%	51	45	0	0	0.00	0	184	162
7:45-8:00	30%	59	52	0	0	0.00	0	198	174
8:00-8:15	25%	94	83	0	0	0.03	83	255	224
8:15-8:30	28%	107	94	12	12	2.92	94	311	273
8:30-8:45	22%	84	74	0	3	0.76	74	344	302
8:45-9:00	26%	98	86	4	7	1.67	86	383	337
9:00-9:15	26%	102	90	7	14	3.46	90	391	344
9:15-9:30	24%	94	83	0	14	3.49	83	378	332
9:30-9:45	24%	94	83	0	14	3.52	83	388	341
9:45-10:00	25%	98	86	4	18	4.43	86	388	341

Total Delay (veh-hr)	20
Total Vehicles Delayed (veh)	678
Average Delay (hr)	0.03
Average Delay (min)	1.80

Maximum Queue (veh)	18
Maximum Queue (ft)	532

Location: SR 65 Capacity & Operational Improvements
Ramp: Pleasant Grove Blvd to Northbound SR 65
Scenario: Design Year Conditions

Configuration: 1 metered + 1 HOV
Peak Hour Volume: 550
Peak Period Volume: 2,030

HOV Bypass (%)	10%
Metered Volume (veh/hr)	495
Metering Rate (veh/hr)	510
Discharge Rate (veh/15 min)	128

Storage Length (ft)	580
Storage Lanes	1
Maximum Storage (veh)	19

Time Interval	Arrival Distribution	15-Minute Volumes	Metered 15-Minute min flows	Excess Demand	Accumulated Vehicles	Total Delay (veh-hr)	Vehicles Delayed	Total Hourly Volume	Metered Hourly Volume
3:00-3:15	24%	116	104	0	0	0.00	0		
3:15-3:30	24%	114	103	0	0	0.00	0		
3:30-3:45	26%	123	111	0	0	0.00	0		
3:45-4:00	26%	125	112	0	0	0.00	0	478	430
4:00-4:15	23%	123	111	0	0	0.00	0	485	436
4:15-4:30	22%	118	106	0	0	0.00	0	489	440
4:30-4:45	27%	144	130	2	2	0.52	130	510	459
4:45-5:00	27%	142	128	0	2	0.59	128	527	474
5:00-5:15	27%	156	140	13	15	3.81	140	560	504
5:15-5:30	25%	142	128	0	16	3.88	128	584	526
5:30-5:45	23%	129	116	0	4	1.02	116	569	512
5:45-6:00	25%	142	128	0	4	1.09	128	569	512
6:00-6:15	23%	122	110	0	0	0.00	0	535	481
6:15-6:30	29%	153	138	10	10	2.54	138	546	491
6:30-6:45	23%	121	109	0	0	0.00	0	538	484
6:45-7:00	24%	125	112	0	0	0.00	0	521	469

Total Delay (veh-hr)	11
Total Vehicles Delayed (veh)	769
Average Delay (hr)	0.01
Average Delay (min)	0.85

Maximum Queue (veh)	16
Maximum Queue (ft)	465

RAMP METERING ANALYSIS

Project: SR 65 Capacity & Operational Improvements
Ramp: Pleasant Grove Blvd to Northbound SR 65
Scenario: Design Year Conditions

Configuration: 2 metered
Peak Hour Volume: 290
Peak Period Volume: 870

HOV Bypass (%)	0%
Metered Volume (veh/hr)	290
Metering Rate (veh/hr)	370
Discharge Rate (veh/15 min)	93

Storage Length (ft)	580
Storage Lanes	2
Maximum Storage (veh)	39

Time Interval	Hourly Arrival Distribution	15-Minute Volumes	Metered 15-Minute min flows	Excess Demand	Accumulated Vehicles	Total Delay (veh-hr)	Vehicles Delayed	Total Hourly Volume	Metered Hourly Volume
6:00-6:15	19%	28	28	0	0	0.00	0		
6:15-6:30	23%	34	34	0	0	0.00	0		
6:30-6:45	27%	39	39	0	0	0.00	0		
6:45-7:00	31%	45	45	0	0	0.00	0	146	146
7:00-7:15	19%	37	37	0	0	0.00	0	155	155
7:15-7:30	26%	51	51	0	0	0.00	0	172	172
7:30-7:45	26%	51	51	0	0	0.00	0	184	184
7:45-8:00	30%	59	59	0	0	0.00	0	198	198
8:00-8:15	25%	94	94	2	2	0.38	94	255	255
8:15-8:30	28%	107	107	15	16	4.00	107	311	311
8:30-8:45	22%	84	84	0	8	1.88	84	344	344
8:45-9:00	26%	98	98	6	13	3.25	98	383	383
9:00-9:15	26%	102	102	10	23	5.63	102	391	391
9:15-9:30	24%	94	94	2	24	6.00	94	378	378
9:30-9:45	24%	94	94	2	26	6.38	94	388	388
9:45-10:00	25%	98	98	6	31	7.75	98	388	388

Total Delay (veh-hr)	35
Total Vehicles Delayed (veh)	771
Average Delay (hr)	0.05
Average Delay (min)	2.74

Maximum Queue (veh)	31
Maximum Queue (ft)	465

Location: SR 65 Capacity & Operational Improvements
Ramp: Pleasant Grove Blvd to Northbound SR 65
Scenario: Design Year Conditions

Configuration: 2 metered
Peak Hour Volume: 550
Peak Period Volume: 2,030

HOV Bypass (%)	0%
Metered Volume (veh/hr)	550
Metering Rate (veh/hr)	550
Discharge Rate (veh/15 min)	138

Storage Length (ft)	580
Storage Lanes	2
Maximum Storage (veh)	39

Time Interval	Arrival Distribution	15-Minute Volumes	Metered 15-Minute min flows	Excess Demand	Accumulated Vehicles	Total Delay (veh-hr)	Vehicles Delayed	Total Hourly Volume	Metered Hourly Volume
3:00-3:15	24%	116	116	0	0	0.00	0		
3:15-3:30	24%	114	114	0	0	0.00	0		
3:30-3:45	26%	123	123	0	0	0.00	0		
3:45-4:00	26%	125	125	0	0	0.00	0	478	478
4:00-4:15	23%	123	123	0	0	0.00	0	485	485
4:15-4:30	22%	118	118	0	0	0.00	0	489	489
4:30-4:45	27%	144	144	7	7	1.63	144	510	510
4:45-5:00	27%	142	142	5	11	2.75	142	527	527
5:00-5:15	27%	156	156	19	30	7.38	156	560	560
5:15-5:30	25%	142	142	5	34	8.50	142	584	584
5:30-5:45	23%	129	129	0	26	6.38	129	569	569
5:45-6:00	25%	142	142	5	30	7.50	142	569	569
6:00-6:15	23%	122	122	0	15	3.63	122	535	535
6:15-6:30	29%	153	153	16	30	7.50	153	546	546
6:30-6:45	23%	121	121	0	14	3.38	121	538	538
6:45-7:00	24%	125	125	0	1	0.25	125	521	521

Total Delay (veh-hr)	34
Total Vehicles Delayed (veh)	855
Average Delay (hr)	0.04
Average Delay (min)	2.39

Maximum Queue (veh)	34
Maximum Queue (ft)	510

RAMP METERING ANALYSIS

Project: SR 65 Capacity & Operational Improvements
Ramp: Blue Oaks Blvd to Northbound SR 65
Scenario: Design Year Conditions

Configuration: 1 metered + 1 HOV
Peak Hour Volume: 610
Peak Period Volume: 2,430

HOV Bypass (%)	10%
Metered Volume (veh/hr)	548
Metering Rate (veh/hr)	635
Discharge Rate (veh/15 min)	159

Storage Length (ft)	470
Storage Lanes	1
Maximum Storage (veh)	16

Time Interval	Hourly Arrival Distribution	15-Minute Volumes	Metered 15-Minute min flows	Excess Demand	Accumulated Vehicles	Total Delay (veh-hr)	Vehicles Delayed	Total Hourly Volume	Metered Hourly Volume
6:00-6:15	22%	71	64	0	0	0.00	0		
6:15-6:30	24%	75	67	0	0	0.00	0		
6:30-6:45	21%	67	60	0	0	0.00	0		
6:45-7:00	33%	105	94	0	0	0.00	0	318	286
7:00-7:15	24%	129	116	0	0	0.00	0	376	338
7:15-7:30	36%	194	174	16	16	3.92	174	495	445
7:30-7:45	13%	73	66	0	0	0.00	0	501	450
7:45-8:00	27%	146	131	0	0	0.00	0	542	487
8:00-8:15	25%	170	153	0	0	0.00	0	583	524
8:15-8:30	23%	154	138	0	0	0.00	0	543	488
8:30-8:45	26%	176	158	0	0	0.00	0	646	581
8:45-9:00	27%	182	164	5	5	1.22	164	682	613
9:00-9:15	27%	170	153	0	0	0.00	0	682	613
9:15-9:30	25%	160	144	0	0	0.00	0	688	619
9:30-9:45	22%	143	129	0	0	0.00	0	655	589
9:45-10:00	26%	167	150	0	0	0.00	0	640	575

Total Delay (veh-hr)	5
Total Vehicles Delayed (veh)	338
Average Delay (hr)	0.02
Average Delay (min)	0.91

Maximum Queue (veh)	16
Maximum Queue (ft)	470

Location: SR 65 Capacity & Operational Improvements
Ramp: Blue Oaks Blvd to Northbound SR 65
Scenario: Design Year Conditions

Configuration: 1 metered + 1 HOV
Peak Hour Volume: 1,000
Peak Period Volume: 3,550

HOV Bypass (%)	17%
Metered Volume (veh/hr)	833
Metering Rate (veh/hr)	900
Discharge Rate (veh/15 min)	225

Storage Length (ft)	470
Storage Lanes	1
Maximum Storage (veh)	16

Time Interval	Arrival Distribution	15-Minute Volumes	Metered 15-Minute min flows	Excess Demand	Accumulated Vehicles	Total Delay (veh-hr)	Vehicles Delayed	Total Hourly Volume	Metered Hourly Volume
3:00-3:15	19%	199	166	0	0	0.00	0		
3:15-3:30	26%	263	219	0	0	0.00	0		
3:30-3:45	30%	311	259	34	34	8.50	259		
3:45-4:00	25%	256	213	0	22	5.55	213	1029	857
4:00-4:15	25%	253	211	0	8	1.97	211	1083	902
4:15-4:30	25%	258	215	0	0	0.00	0	1078	898
4:30-4:45	27%	274	228	3	3	0.80	228	1041	867
4:45-5:00	23%	239	199	0	0	0.00	0	1024	853
5:00-5:15	24%	235	196	0	0	0.00	0	1006	838
5:15-5:30	31%	300	250	25	25	6.21	250	1048	873
5:30-5:45	23%	219	182	0	0	0.00	0	993	827
5:45-6:00	23%	219	182	0	0	0.00	0	973	810
6:00-6:15	26%	234	195	0	0	0.00	0	972	809
6:15-6:30	30%	268	223	0	0	0.00	0	940	783
6:30-6:45	23%	211	176	0	0	0.00	0	932	776
6:45-7:00	21%	191	159	0	0	0.00	0	904	753

Total Delay (veh-hr)	23
Total Vehicles Delayed (veh)	1,161
Average Delay (hr)	0.02
Average Delay (min)	1.19

Maximum Queue (veh)	34
Maximum Queue (ft)	1,020

RAMP METERING ANALYSIS

Location: SR 65/Blue Oaks Blvd
 Ramp: Blue Oaks Blvd to Northbound SR 65
 Scenario: Design Year Conditions

Configuration: 2 metered
 Peak Hour Volume: 610
 Peak Period Volume: 2,430

HOV Bypass (%)	0%
Metered Volume (veh/hr)	610
Metering Rate (veh/hr)	665
Discharge Rate (veh/15 min)	166

Storage Length (ft)	470
Storage Lanes	2
Maximum Storage (veh)	31

Time Interval	Hourly Arrival Distribution	15-Minute Volumes	Metered 15-Minute min flows	Excess Demand	Accumulated Vehicles	Total Delay (veh-hr)	Vehicles Delayed	Total Hourly Volume	Metered Hourly Volume
6:00-6:15	22%	71	71	0	0	0.00	0		
6:15-6:30	24%	75	75	0	0	0.00	0		
6:30-6:45	21%	67	67	0	0	0.00	0		
6:45-7:00	33%	105	105	0	0	0.00	0	318	318
7:00-7:15	24%	129	129	0	0	0.00	0	376	376
7:15-7:30	36%	194	194	28	28	6.94	194	495	495
7:30-7:45	13%	73	73	0	0	0.00	0	501	501
7:45-8:00	27%	146	146	0	0	0.00	0	542	542
8:00-8:15	25%	170	170	4	4	0.94	170	583	583
8:15-8:30	23%	154	154	0	0	0.00	0	543	543
8:30-8:45	26%	176	176	10	10	2.44	176	646	646
8:45-9:00	27%	182	182	16	26	6.38	182	682	682
9:00-9:15	27%	170	170	4	29	7.31	170	682	682
9:15-9:30	25%	160	160	0	23	5.75	160	688	688
9:30-9:45	22%	143	143	0	0	0.00	0	655	655
9:45-10:00	26%	167	167	1	1	0.19	167	640	640

Total Delay (veh-hr)	30
Total Vehicles Delayed (veh)	1,219
Average Delay (hr)	0.02
Average Delay (min)	1.47

Maximum Queue (veh)	29
Maximum Queue (ft)	439

Location: SR 65/Blue Oaks Blvd
 Ramp: Blue Oaks Blvd to Northbound SR 65
 Scenario: Design Year Conditions

Configuration: 2 metered
 Peak Hour Volume: 1,000
 Peak Period Volume: 3,550

HOV Bypass (%)	0%
Metered Volume (veh/hr)	1,000
Metering Rate (veh/hr)	1,120
Discharge Rate (veh/15 min)	280

Storage Length (ft)	470
Storage Lanes	2
Maximum Storage (veh)	31

Time Interval	Arrival Distribution	15-Minute Volumes	Metered 15-Minute min flows	Excess Demand	Accumulated Vehicles	Total Delay (veh-hr)	Vehicles Delayed	Total Hourly Volume	Metered Hourly Volume
3:00-3:15	19%	199	199	0	0	0.00	0		
3:15-3:30	26%	263	263	0	0	0.00	0		
3:30-3:45	30%	311	311	31	31	7.75	311		
3:45-4:00	25%	256	256	0	7	1.75	256	1029	1029
4:00-4:15	25%	253	253	0	0	0.00	0	1083	1083
4:15-4:30	25%	258	258	0	0	0.00	0	1078	1078
4:30-4:45	27%	274	274	0	0	0.00	0	1041	1041
4:45-5:00	23%	239	239	0	0	0.00	0	1024	1024
5:00-5:15	24%	235	235	0	0	0.00	0	1006	1006
5:15-5:30	31%	300	300	20	20	5.00	300	1048	1048
5:30-5:45	23%	219	219	0	0	0.00	0	993	993
5:45-6:00	23%	219	219	0	0	0.00	0	973	973
6:00-6:15	26%	234	234	0	0	0.00	0	972	972
6:15-6:30	30%	268	268	0	0	0.00	0	940	940
6:30-6:45	23%	211	211	0	0	0.00	0	932	932
6:45-7:00	21%	191	191	0	0	0.00	0	904	904

Total Delay (veh-hr)	15
Total Vehicles Delayed (veh)	867
Average Delay (hr)	0.02
Average Delay (min)	1.00

Maximum Queue (veh)	31
Maximum Queue (ft)	465

RAMP METERING ANALYSIS

Project: SR 65 Capacity & Operational Improvements
Ramp: Eastbound Sunset Blvd to NB SR 65
Scenario: Design Year Conditions

Configuration: 1 metered + 1 HOV
Peak Hour Volume: 160
Peak Period Volume: 580

HOV Bypass (%)	17%
Metered Volume (veh/hr)	133
Metering Rate (veh/hr)	240
Discharge Rate (veh/15 min)	60

Storage Length (ft)	570
Storage Lanes	1
Maximum Storage (veh)	19

Time Interval	Hourly Arrival Distribution	15-Minute Volumes	Metered 15-Minute min flows	Excess Demand	Accumulated Vehicles	Total Delay (veh-hr)	Vehicles Delayed	Total Hourly Volume	Metered Hourly Volume
6:00-6:15	25%	34	28	0	0	0.00	0		
6:15-6:30	25%	34	28	0	0	0.00	0		
6:30-6:45	25%	34	28	0	0	0.00	0		
6:45-7:00	25%	34	28	0	0	0.00	0	136	113
7:00-7:15	14%	16	13	0	0	0.00	0	118	98
7:15-7:30	36%	42	35	0	0	0.00	0	126	105
7:30-7:45	18%	21	17	0	0	0.00	0	113	94
7:45-8:00	32%	37	31	0	0	0.00	0	116	96
8:00-8:15	30%	59	49	0	0	0.00	0	159	132
8:15-8:30	17%	33	27	0	0	0.00	0	150	124
8:30-8:45	27%	52	43	0	0	0.00	0	181	150
8:45-9:00	27%	52	43	0	0	0.00	0	196	163
9:00-9:15	26%	18	15	0	0	0.00	0	155	129
9:15-9:30	26%	18	15	0	0	0.00	0	140	116
9:30-9:45	26%	18	15	0	0	0.00	0	106	88
9:45-10:00	22%	16	13	0	0	0.00	0	70	58

Total Delay (veh-hr)	0
Total Vehicles Delayed (veh)	0
Average Delay (hr)	0.00
Average Delay (min)	0.00

Maximum Queue (veh)	0
Maximum Queue (ft)	0

Location: SR 65 Capacity & Operational Improvements
Ramp: Eastbound Sunset Blvd to NB SR 65
Scenario: Design Year Conditions

Configuration: 1 metered + 1 HOV
Peak Hour Volume: 420
Peak Period Volume: 1,630

HOV Bypass (%)	15%
Metered Volume (veh/hr)	356
Metering Rate (veh/hr)	445
Discharge Rate (veh/15 min)	111

Storage Length (ft)	570
Storage Lanes	1
Maximum Storage (veh)	19

Time Interval	Arrival Distribution	15-Minute Volumes	Metered 15-Minute min flows	Excess Demand	Accumulated Vehicles	Total Delay (veh-hr)	Vehicles Delayed	Total Hourly Volume	Metered Hourly Volume
3:00-3:15	23%	49	42	0	0	0.00	0		
3:15-3:30	25%	53	45	0	0	0.00	0		
3:30-3:45	32%	69	58	0	0	0.00	0		
3:45-4:00	21%	45	38	0	0	0.00	0	216	183
4:00-4:15	33%	100	85	0	0	0.00	0	267	226
4:15-4:30	22%	68	58	0	0	0.00	0	282	239
4:30-4:45	33%	100	85	0	0	0.00	0	313	265
4:45-5:00	12%	36	30	0	0	0.00	0	304	258
5:00-5:15	26%	139	118	6	6	1.62	118	343	291
5:15-5:30	20%	108	91	0	0	0.00	0	383	324
5:30-5:45	28%	146	124	12	12	3.11	124	429	363
5:45-6:00	26%	139	118	6	19	4.73	118	532	451
6:00-6:15	35%	53	45	0	0	0.00	0	446	378
6:15-6:30	25%	38	32	0	0	0.00	0	376	318
6:30-6:45	27%	41	35	0	0	0.00	0	271	230
6:45-7:00	12%	18	15	0	0	0.00	0	150	127

Total Delay (veh-hr)	9
Total Vehicles Delayed (veh)	359
Average Delay (hr)	0.03
Average Delay (min)	1.58

Maximum Queue (veh)	19
Maximum Queue (ft)	567

RAMP METERING ANALYSIS

Project: SR 65 Capacity & Operational Improvements
Ramp: Westbound Sunset Blvd to NB SR 65
Scenario: Design Year Conditions

Configuration: 1 metered + 1 HOV
Peak Hour Volume: 270
Peak Period Volume: 700

HOV Bypass (%)	14%
Metered Volume (veh/hr)	232
Metering Rate (veh/hr)	260
Discharge Rate (veh/15 min)	65

Storage Length (ft)	800
Storage Lanes	1
Maximum Storage (veh)	27

Time Interval	Hourly Arrival Distribution	15-Minute Volumes	Metered 15-Minute min flows	Excess Demand	Accumulated Vehicles	Total Delay (veh-hr)	Vehicles Delayed	Total Hourly Volume	Metered Hourly Volume
6:00-6:15	22%	30	26	0	0	0.00	0		
6:15-6:30	22%	30	26	0	0	0.00	0		
6:30-6:45	25%	35	30	0	0	0.00	0		
6:45-7:00	32%	45	39	0	0	0.00	0	140	120
7:00-7:15	15%	45	39	0	0	0.00	0	155	133
7:15-7:30	25%	75	64	0	0	0.00	0	200	172
7:30-7:45	30%	90	77	12	12	3.05	77	255	219
7:45-8:00	29%	87	75	10	22	5.46	75	297	255
8:00-8:15	29%	72	62	0	19	4.65	62	324	278
8:15-8:30	35%	85	73	8	27	6.63	73	334	287
8:30-8:45	21%	51	44	0	5	1.31	44	295	253
8:45-9:00	15%	36	31	0	0	0.00	0	244	209
9:00-9:15	17%	34	29	0	0	0.00	0	206	177
9:15-9:30	31%	63	54	0	0	0.00	0	184	158
9:30-9:45	32%	65	56	0	0	0.00	0	198	170
9:45-10:00	20%	40	34	0	0	0.00	0	202	173

Total Delay (veh-hr)	21
Total Vehicles Delayed (veh)	330
Average Delay (hr)	0.06
Average Delay (min)	3.83

Maximum Queue (veh)	27
Maximum Queue (ft)	795

Location: SR 65 Capacity & Operational Improvements
Ramp: Westbound Sunset Blvd to NB SR 65
Scenario: Design Year Conditions

Configuration: 1 metered + 1 HOV
Peak Hour Volume: 480
Peak Period Volume: 1,830

HOV Bypass (%)	20%
Metered Volume (veh/hr)	385
Metering Rate (veh/hr)	405
Discharge Rate (veh/15 min)	101

Storage Length (ft)	800
Storage Lanes	1
Maximum Storage (veh)	27

Time Interval	Arrival Distribution	15-Minute Volumes	Metered 15-Minute min flows	Excess Demand	Accumulated Vehicles	Total Delay (veh-hr)	Vehicles Delayed	Total Hourly Volume	Metered Hourly Volume
3:00-3:15	23%	101	81	0	0	0.00	0		
3:15-3:30	24%	107	86	0	0	0.00	0		
3:30-3:45	28%	125	100	0	0	0.00	0		
3:45-4:00	25%	110	88	0	0	0.00	0	443	356
4:00-4:15	22%	116	93	0	0	0.00	0	458	368
4:15-4:30	28%	147	118	17	17	4.20	118	498	400
4:30-4:45	26%	137	110	9	26	6.38	110	510	410
4:45-5:00	23%	119	96	0	20	4.96	96	519	417
5:00-5:15	25%	110	88	0	7	1.73	88	513	412
5:15-5:30	25%	110	88	0	0	0.00	0	476	382
5:30-5:45	26%	115	92	0	0	0.00	0	454	365
5:45-6:00	25%	113	91	0	0	0.00	0	448	360
6:00-6:15	31%	112	90	0	0	0.00	0	450	361
6:15-6:30	28%	101	81	0	0	0.00	0	441	354
6:30-6:45	19%	71	57	0	0	0.00	0	397	319
6:45-7:00	22%	81	65	0	0	0.00	0	365	293

Total Delay (veh-hr)	17
Total Vehicles Delayed (veh)	412
Average Delay (hr)	0.04
Average Delay (min)	2.51

Maximum Queue (veh)	26
Maximum Queue (ft)	766

RAMP METERING ANALYSIS

Project: SR 65 Capacity & Operational Improvements
Ramp: EB Whitney Ranch Pkwy to NB SR 65
Scenario: Design Year Conditions

Configuration: 1 metered + 1 HOV
Peak Hour Volume: 480
Peak Period Volume: 1,750

HOV Bypass (%)	12%
Metered Volume (veh/hr)	420
Metering Rate (veh/hr)	555
Discharge Rate (veh/15 min)	139

Storage Length (ft)	590
Storage Lanes	1
Maximum Storage (veh)	20

Time Interval	Hourly Arrival Distribution	15-Minute Volumes	Metered 15-Minute min flows	Excess Demand	Accumulated Vehicles	Total Delay (veh-hr)	Vehicles Delayed	Total Hourly Volume	Metered Hourly Volume
6:00-6:15	25%	47	41	0	0	0.00	0		
6:15-6:30	25%	47	41	0	0	0.00	0		
6:30-6:45	25%	47	41	0	0	0.00	0		
6:45-7:00	25%	47	41	0	0	0.00	0	188	165
7:00-7:15	14%	50	44	0	0	0.00	0	191	167
7:15-7:30	36%	135	118	0	0	0.00	0	279	244
7:30-7:45	18%	67	59	0	0	0.00	0	299	262
7:45-8:00	32%	118	103	0	0	0.00	0	370	324
8:00-8:15	30%	180	158	19	19	4.69	158	500	438
8:15-8:30	17%	100	88	0	0	0.00	0	465	407
8:30-8:45	27%	160	140	1	1	0.31	140	558	488
8:45-9:00	27%	160	140	1	3	0.63	140	600	525
9:00-9:15	26%	67	59	0	0	0.00	0	487	426
9:15-9:30	26%	67	59	0	0	0.00	0	454	397
9:30-9:45	26%	67	59	0	0	0.00	0	361	316
9:45-10:00	22%	57	50	0	0	0.00	0	258	226

Total Delay (veh-hr)	6
Total Vehicles Delayed (veh)	438
Average Delay (hr)	0.01
Average Delay (min)	0.77

Maximum Queue (veh)	19
Maximum Queue (ft)	563

Location: SR 65 Capacity & Operational Improvements
Ramp: EB Whitney Ranch Pkwy to NB SR 65
Scenario: Design Year Conditions

Configuration: 1 metered + 1 HOV
Peak Hour Volume: 420
Peak Period Volume: 1,630

HOV Bypass (%)	18%
Metered Volume (veh/hr)	345
Metering Rate (veh/hr)	595
Discharge Rate (veh/15 min)	149

Storage Length (ft)	590
Storage Lanes	1
Maximum Storage (veh)	20

Time Interval	Arrival Distribution	15-Minute Volumes	Metered 15-Minute min flows	Excess Demand	Accumulated Vehicles	Total Delay (veh-hr)	Vehicles Delayed	Total Hourly Volume	Metered Hourly Volume
3:00-3:15	23%	144	118	0	0	0.00	0		
3:15-3:30	25%	156	128	0	0	0.00	0		
3:30-3:45	32%	204	168	19	19	4.73	168		
3:45-4:00	21%	132	108	0	0	0.00	0	636	523
4:00-4:15	33%	136	112	0	0	0.00	0	628	516
4:15-4:30	22%	93	76	0	0	0.00	0	565	464
4:30-4:45	33%	136	112	0	0	0.00	0	497	409
4:45-5:00	12%	49	40	0	0	0.00	0	414	340
5:00-5:15	26%	113	93	0	0	0.00	0	391	321
5:15-5:30	20%	88	72	0	0	0.00	0	386	317
5:30-5:45	28%	120	99	0	0	0.00	0	370	304
5:45-6:00	26%	113	93	0	0	0.00	0	434	357
6:00-6:15	35%	208	171	22	22	5.55	171	529	435
6:15-6:30	25%	150	123	0	0	0.00	0	591	486
6:30-6:45	27%	162	133	0	0	0.00	0	633	520
6:45-7:00	12%	69	57	0	0	0.00	0	589	484

Total Delay (veh-hr)	5
Total Vehicles Delayed (veh)	168
Average Delay (hr)	0.03
Average Delay (min)	1.69

Maximum Queue (veh)	19
Maximum Queue (ft)	568

RAMP METERING ANALYSIS

Project: SR 65 Capacity & Operational Improvements
Ramp: WB Whitney Ranch Pkwy to NB SR 65
Scenario: Design Year Conditions

Configuration: 1 metered + 1 HOV
Peak Hour Volume: 430
Peak Period Volume: 1,120

HOV Bypass (%)	15%
Metered Volume (veh/hr)	367
Metering Rate (veh/hr)	470
Discharge Rate (veh/15 min)	118

Storage Length (ft)	870
Storage Lanes	1
Maximum Storage (veh)	29

Time Interval	Hourly Arrival Distribution	15-Minute Volumes	Metered 15-Minute min flows	Excess Demand	Accumulated Vehicles	Total Delay (veh-hr)	Vehicles Delayed	Total Hourly Volume	Metered Hourly Volume
6:00-6:15	22%	36	31	0	0	0.00	0		
6:15-6:30	22%	36	31	0	0	0.00	0		
6:30-6:45	25%	42	36	0	0	0.00	0		
6:45-7:00	32%	54	46	0	0	0.00	0	168	143
7:00-7:15	15%	78	66	0	0	0.00	0	210	179
7:15-7:30	25%	129	110	0	0	0.00	0	303	258
7:30-7:45	30%	156	133	15	15	3.87	133	417	355
7:45-8:00	29%	151	129	11	27	6.67	129	514	438
8:00-8:15	29%	101	86	0	0	0.00	0	537	458
8:15-8:30	35%	120	102	0	0	0.00	0	528	450
8:30-8:45	21%	72	61	0	0	0.00	0	444	378
8:45-9:00	15%	51	43	0	0	0.00	0	344	293
9:00-9:15	17%	46	39	0	0	0.00	0	289	246
9:15-9:30	31%	85	72	0	0	0.00	0	254	217
9:30-9:45	32%	87	74	0	0	0.00	0	269	229
9:45-10:00	20%	53	45	0	0	0.00	0	271	231

Total Delay (veh-hr)	11
Total Vehicles Delayed (veh)	262
Average Delay (hr)	0.04
Average Delay (min)	2.42

Maximum Queue (veh)	27
Maximum Queue (ft)	800

Location: SR 65 Capacity & Operational Improvements
Ramp: WB Whitney Ranch Pkwy to NB SR 65
Scenario: Design Year Conditions

Configuration: 1 metered + 1 HOV
Peak Hour Volume: 670
Peak Period Volume: 2,550

HOV Bypass (%)	18%
Metered Volume (veh/hr)	547
Metering Rate (veh/hr)	745
Discharge Rate (veh/15 min)	186

Storage Length (ft)	870
Storage Lanes	1
Maximum Storage (veh)	29

Time Interval	Arrival Distribution	15-Minute Volumes	Metered 15-Minute min flows	Excess Demand	Accumulated Vehicles	Total Delay (veh-hr)	Vehicles Delayed	Total Hourly Volume	Metered Hourly Volume
3:00-3:15	23%	211	172	0	0	0.00	0		
3:15-3:30	24%	223	182	0	0	0.00	0		
3:30-3:45	28%	261	213	27	27	6.68	213		
3:45-4:00	25%	230	188	1	28	7.04	188	925	755
4:00-4:15	22%	154	126	0	0	0.00	0	868	708
4:15-4:30	28%	195	159	0	0	0.00	0	840	685
4:30-4:45	26%	181	148	0	0	0.00	0	760	620
4:45-5:00	23%	157	128	0	0	0.00	0	687	561
5:00-5:15	25%	161	131	0	0	0.00	0	694	566
5:15-5:30	25%	161	131	0	0	0.00	0	660	539
5:30-5:45	26%	168	137	0	0	0.00	0	647	528
5:45-6:00	25%	166	135	0	0	0.00	0	656	535
6:00-6:15	31%	208	170	0	0	0.00	0	703	574
6:15-6:30	28%	187	153	0	0	0.00	0	729	595
6:30-6:45	19%	132	108	0	0	0.00	0	693	566
6:45-7:00	22%	150	122	0	0	0.00	0	677	552

Total Delay (veh-hr)	14
Total Vehicles Delayed (veh)	401
Average Delay (hr)	0.03
Average Delay (min)	2.06

Maximum Queue (veh)	28
Maximum Queue (ft)	845

RAMP METERING ANALYSIS

Location: SR 65/Twelve Bridges Dr
 Ramp: Twelve Bridges Dr to Northbound SR 65
 Scenario: Design Year Conditions

Configuration: 1 metered + 1 HOV
 Peak Hour Volume: 880
 Peak Period Volume: 1,700

HOV Bypass (%)	22%
Metered Volume (veh/hr)	684
Metering Rate (veh/hr)	900
Discharge Rate (veh/15 min)	225

Storage Length (ft)	950
Storage Lanes	1
Maximum Storage (veh)	32

Time Interval	Hourly Arrival Distribution	15-Minute Volumes	Metered 15-Minute min flows	Excess Demand	Accumulated Vehicles	Total Delay (veh-hr)	Vehicles Delayed	Total Hourly Volume	Metered Hourly Volume
6:00-6:15	13%	18	14	0	0	0.00	0		
6:15-6:30	28%	39	30	0	0	0.00	0		
6:30-6:45	30%	41	32	0	0	0.00	0		
6:45-7:00	28%	39	30	0	0	0.00	0	137	106
7:00-7:15	9%	60	47	0	0	0.00	0	179	139
7:15-7:30	14%	87	68	0	0	0.00	0	227	176
7:30-7:45	38%	239	186	0	0	0.00	0	425	330
7:45-8:00	39%	249	193	0	0	0.00	0	635	493
8:00-8:15	42%	467	363	138	138	34.46	363	1042	810
8:15-8:30	20%	223	173	0	86	21.53	173	1178	915
8:30-8:45	20%	219	170	0	31	7.82	170	1158	900
8:45-9:00	19%	210	163	0	0	0.00	0	1119	869
9:00-9:15	20%	128	99	0	0	0.00	0	780	606
9:15-9:30	29%	190	148	0	0	0.00	0	747	580
9:30-9:45	24%	155	120	0	0	0.00	0	683	531
9:45-10:00	28%	181	141	0	0	0.00	0	654	508

Total Delay (veh-hr)	64
Total Vehicles Delayed (veh)	706
Average Delay (hr)	0.09
Average Delay (min)	5.42

Maximum Queue (veh)	138
Maximum Queue (ft)	4,136

Location: SR 65/Twelve Bridges Dr
 Ramp: Twelve Bridges Dr to Northbound SR 65
 Scenario: Design Year Conditions

Configuration: 1 metered + 1 HOV
 Peak Hour Volume: 1,030
 Peak Period Volume: 3,390

HOV Bypass (%)	20%
Metered Volume (veh/hr)	827
Metering Rate (veh/hr)	900
Discharge Rate (veh/15 min)	225

Storage Length (ft)	950
Storage Lanes	1
Maximum Storage (veh)	32

Time Interval	Arrival Distribution	15-Minute Volumes	Metered 15-Minute min flows	Excess Demand	Accumulated Vehicles	Total Delay (veh-hr)	Vehicles Delayed	Total Hourly Volume	Metered Hourly Volume
3:00-3:15	28%	309	248	23	23	5.74	248		
3:15-3:30	23%	255	205	0	3	0.66	205		
3:30-3:45	25%	284	228	3	6	1.38	228		
3:45-4:00	24%	266	213	0	0	0.00	0	1114	894
4:00-4:15	27%	285	229	4	4	0.93	229	1090	875
4:15-4:30	22%	235	189	0	0	0.00	0	1070	859
4:30-4:45	26%	270	217	0	0	0.00	0	1056	847
4:45-5:00	25%	263	211	0	0	0.00	0	1053	845
5:00-5:15	32%	321	258	33	33	8.15	258	1089	874
5:15-5:30	26%	257	206	0	14	3.46	206	1111	892
5:30-5:45	21%	206	165	0	0	0.00	0	1047	840
5:45-6:00	21%	213	171	0	0	0.00	0	997	800
6:00-6:15	24%	239	192	0	0	0.00	0	915	734
6:15-6:30	38%	375	301	76	76	18.99	301	1033	829
6:30-6:45	19%	185	148	0	0	0.00	0	1012	812
6:45-7:00	20%	195	156	0	0	0.00	0	994	798

Total Delay (veh-hr)	20
Total Vehicles Delayed (veh)	1,373
Average Delay (hr)	0.01
Average Delay (min)	0.89

Maximum Queue (veh)	33
Maximum Queue (ft)	978

RAMP METERING ANALYSIS

Project: SR 65 Capacity & Operational Improvements
Ramp: Twelve Bridges Dr to Northbound SR 65
Scenario: Design Year Conditions

Configuration: 2 metered
Peak Hour Volume: 880
Peak Period Volume: 1,700

HOV Bypass (%)	0%
Metered Volume (veh/hr)	880
Metering Rate (veh/hr)	1,645
Discharge Rate (veh/15 min)	411

Storage Length (ft)	850
Storage Lanes	2
Maximum Storage (veh)	57

Time Interval	Hourly Arrival Distribution	15-Minute Volumes	Metered 15-Minute min flows	Excess Demand	Accumulated Vehicles	Total Delay (veh-hr)	Vehicles Delayed	Total Hourly Volume	Metered Hourly Volume
6:00-6:15	13%	18	18	0	0	0.00	0		
6:15-6:30	28%	39	39	0	0	0.00	0		
6:30-6:45	30%	41	41	0	0	0.00	0		
6:45-7:00	28%	39	39	0	0	0.00	0	137	137
7:00-7:15	9%	60	60	0	0	0.00	0	179	179
7:15-7:30	14%	87	87	0	0	0.00	0	227	227
7:30-7:45	38%	239	239	0	0	0.00	0	425	425
7:45-8:00	39%	249	249	0	0	0.00	0	635	635
8:00-8:15	42%	467	467	56	56	13.94	467	1042	1042
8:15-8:30	20%	223	223	0	0	0.00	0	1178	1178
8:30-8:45	20%	219	219	0	0	0.00	0	1158	1158
8:45-9:00	19%	210	210	0	0	0.00	0	1119	1119
9:00-9:15	20%	128	128	0	0	0.00	0	780	780
9:15-9:30	29%	190	190	0	0	0.00	0	747	747
9:30-9:45	24%	155	155	0	0	0.00	0	683	683
9:45-10:00	28%	181	181	0	0	0.00	0	654	654

Total Delay (veh-hr)	14
Total Vehicles Delayed (veh)	467
Average Delay (hr)	0.03
Average Delay (min)	1.79

Maximum Queue (veh)	56
Maximum Queue (ft)	836

Location: SR 65 Capacity & Operational Improvements
Ramp: Twelve Bridges Dr to Northbound SR 65
Scenario: Design Year Conditions

Configuration: 2 metered
Peak Hour Volume: 1,030
Peak Period Volume: 3,390

HOV Bypass (%)	0%
Metered Volume (veh/hr)	1,030
Metering Rate (veh/hr)	1,085
Discharge Rate (veh/15 min)	271

Storage Length (ft)	850
Storage Lanes	2
Maximum Storage (veh)	57

Time Interval	Arrival Distribution	15-Minute Volumes	Metered 15-Minute min flows	Excess Demand	Accumulated Vehicles	Total Delay (veh-hr)	Vehicles Delayed	Total Hourly Volume	Metered Hourly Volume
3:00-3:15	28%	309	309	38	38	9.44	309		
3:15-3:30	23%	255	255	0	22	5.38	255		
3:30-3:45	25%	284	284	13	34	8.56	284		
3:45-4:00	24%	266	266	0	29	7.25	266	1114	1114
4:00-4:15	27%	285	285	14	43	10.69	285	1090	1090
4:15-4:30	22%	235	235	0	7	1.63	235	1070	1070
4:30-4:45	26%	270	270	0	5	1.31	270	1056	1056
4:45-5:00	25%	263	263	0	0	0.00	0	1053	1053
5:00-5:15	32%	321	321	50	50	12.44	321	1089	1089
5:15-5:30	26%	257	257	0	36	8.88	257	1111	1111
5:30-5:45	21%	206	206	0	0	0.00	0	1047	1047
5:45-6:00	21%	213	213	0	0	0.00	0	997	997
6:00-6:15	24%	239	239	0	0	0.00	0	915	915
6:15-6:30	38%	375	375	104	104	25.94	375	1033	1033
6:30-6:45	19%	185	185	0	18	4.38	185	1012	1012
6:45-7:00	20%	195	195	0	0	0.00	0	994	994

Total Delay (veh-hr)	66
Total Vehicles Delayed (veh)	2,482
Average Delay (hr)	0.03
Average Delay (min)	1.58

Maximum Queue (veh)	50
Maximum Queue (ft)	746

RAMP METERING ANALYSIS

Project: SR 65 Capacity & Operational Improvements
Ramp: Twelve Bridges Dr to Northbound SR 65
Scenario: Design Year Conditions

Configuration: 2 metered + 1 HOV
Peak Hour Volume: 880
Peak Period Volume: 1,700

HOV Bypass (%)	22%
Metered Volume (veh/hr)	684
Metering Rate (veh/hr)	1,225
Discharge Rate (veh/15 min)	306

Storage Length (ft)	850
Storage Lanes	2
Maximum Storage (veh)	57

Time Interval	Hourly Arrival Distribution	15-Minute Volumes	Metered 15-Minute min flows	Excess Demand	Accumulated Vehicles	Total Delay (veh-hr)	Vehicles Delayed	Total Hourly Volume	Metered Hourly Volume
6:00-6:15	13%	18	14	0	0	0.00	0		
6:15-6:30	28%	39	30	0	0	0.00	0		
6:30-6:45	30%	41	32	0	0	0.00	0		
6:45-7:00	28%	39	30	0	0	0.00	0	137	106
7:00-7:15	9%	60	47	0	0	0.00	0	179	139
7:15-7:30	14%	87	68	0	0	0.00	0	227	176
7:30-7:45	38%	239	186	0	0	0.00	0	425	330
7:45-8:00	39%	249	193	0	0	0.00	0	635	493
8:00-8:15	42%	467	363	57	57	14.15	363	1042	810
8:15-8:30	20%	223	173	0	0	0.00	0	1178	915
8:30-8:45	20%	219	170	0	0	0.00	0	1158	900
8:45-9:00	19%	210	163	0	0	0.00	0	1119	869
9:00-9:15	20%	128	99	0	0	0.00	0	780	606
9:15-9:30	29%	190	148	0	0	0.00	0	747	580
9:30-9:45	24%	155	120	0	0	0.00	0	683	531
9:45-10:00	28%	181	141	0	0	0.00	0	654	508

Total Delay (veh-hr)	14
Total Vehicles Delayed (veh)	363
Average Delay (hr)	0.04
Average Delay (min)	2.34

Maximum Queue (veh)	57
Maximum Queue (ft)	849

Location: SR 65 Capacity & Operational Improvements
Ramp: Twelve Bridges Dr to Northbound SR 65
Scenario: Design Year Conditions

Configuration: 2 metered + 1 HOV
Peak Hour Volume: 1,030
Peak Period Volume: 3,390

HOV Bypass (%)	20%
Metered Volume (veh/hr)	827
Metering Rate (veh/hr)	865
Discharge Rate (veh/15 min)	216

Storage Length (ft)	850
Storage Lanes	2
Maximum Storage (veh)	57

Time Interval	Arrival Distribution	15-Minute Volumes	Metered 15-Minute min flows	Excess Demand	Accumulated Vehicles	Total Delay (veh-hr)	Vehicles Delayed	Total Hourly Volume	Metered Hourly Volume
3:00-3:15	28%	309	248	32	32	7.93	248		
3:15-3:30	23%	255	205	0	20	5.03	205		
3:30-3:45	25%	284	228	12	32	7.95	228		
3:45-4:00	24%	266	213	0	29	7.25	213	1114	894
4:00-4:15	27%	285	229	12	41	10.37	229	1090	875
4:15-4:30	22%	235	189	0	14	3.46	189	1070	859
4:30-4:45	26%	270	217	0	14	3.56	217	1056	847
4:45-5:00	25%	263	211	0	9	2.27	211	1053	845
5:00-5:15	32%	321	258	41	50	12.61	258	1089	874
5:15-5:30	26%	257	206	0	40	10.11	206	1111	892
5:30-5:45	21%	206	165	0	0	0.00	0	1047	840
5:45-6:00	21%	213	171	0	0	0.00	0	997	800
6:00-6:15	24%	239	192	0	0	0.00	0	915	734
6:15-6:30	38%	375	301	85	85	21.17	301	1033	829
6:30-6:45	19%	185	148	0	17	4.23	148	1012	812
6:45-7:00	20%	195	156	0	0	0.00	0	994	798

Total Delay (veh-hr)	71
Total Vehicles Delayed (veh)	2,203
Average Delay (hr)	0.03
Average Delay (min)	1.92

Maximum Queue (veh)	50
Maximum Queue (ft)	756

RAMP METERING ANALYSIS

Project: SR 65 Capacity & Operational Improvements
Ramp: Lincoln Blvd to Southbound SR 65
Scenario: Design Year Conditions

Configuration: 1 metered + 1 HOV
Peak Hour Volume: 1,540
Peak Period Volume: 4,190

HOV Bypass (%)	19%
Metered Volume (veh/hr)	1,251
Metering Rate (veh/hr)	900
Discharge Rate (veh/15 min)	225

Storage Length (ft)	540
Storage Lanes	1
Maximum Storage (veh)	18

Time Interval	Hourly Arrival Distribution	15-Minute Volumes	Metered 15-Minute min flows	Excess Demand	Accumulated Vehicles	Total Delay (veh-hr)	Vehicles Delayed	Total Hourly Volume	Metered Hourly Volume
6:00-6:15	22%	293	238	13	13	3.28	238		
6:15-6:30	22%	289	235	10	23	5.74	235		
6:30-6:45	28%	374	304	79	102	25.47	304		
6:45-7:00	29%	386	314	89	191	47.64	314	1342	1091
7:00-7:15	19%	289	235	10	200	50.11	235	1338	1087
7:15-7:30	22%	323	262	37	238	59.48	262	1372	1115
7:30-7:45	30%	444	361	136	374	93.43	361	1442	1172
7:45-8:00	29%	435	354	129	502	125.56	354	1491	1212
8:00-8:15	29%	459	373	148	650	162.56	373	1661	1350
8:15-8:30	26%	409	332	107	758	189.40	332	1747	1420
8:30-8:45	22%	345	280	55	813	203.24	280	1648	1339
8:45-9:00	24%	382	310	85	898	224.60	310	1595	1296
9:00-9:15	26%	376	306	81	979	244.74	306	1512	1229
9:15-9:30	21%	305	248	23	1002	250.45	248	1408	1144
9:30-9:45	26%	370	301	76	1077	269.37	301	1433	1165
9:45-10:00	26%	368	299	74	1152	287.89	299	1419	1153

Total Delay (veh-hr)	2,243
Total Vehicles Delayed (veh)	4,752
Average Delay (hr)	0.47
Average Delay (min)	28.32

Maximum Queue (veh)	1152
Maximum Queue (ft)	34,546

Location: SR 65 Capacity & Operational Improvements
Ramp: Lincoln Blvd to Southbound SR 65
Scenario: Design Year Conditions

Configuration: 1 metered + 1 HOV
Peak Hour Volume: 1,470
Peak Period Volume: 4,570

HOV Bypass (%)	14%
Metered Volume (veh/hr)	1,268
Metering Rate (veh/hr)	900
Discharge Rate (veh/15 min)	225

Storage Length (ft)	540
Storage Lanes	1
Maximum Storage (veh)	18

Time Interval	Hourly Arrival Distribution	15-Minute Volumes	Metered 15-Minute min flows	Excess Demand	Accumulated Vehicles	Total Delay (veh-hr)	Vehicles Delayed	Total Hourly Volume	Metered Hourly Volume
3:00-3:15	28%	380	328	103	103	25.72	328		
3:15-3:30	27%	360	311	86	188	47.12	311		
3:30-3:45	23%	312	269	44	233	58.17	269		
3:45-4:00	23%	306	264	39	272	67.93	264	1358	1172
4:00-4:15	28%	431	372	147	419	104.64	372	1409	1216
4:15-4:30	24%	371	320	95	514	128.42	320	1420	1225
4:30-4:45	23%	348	300	75	589	147.24	300	1456	1256
4:45-5:00	24%	369	318	93	682	170.58	318	1519	1311
5:00-5:15	26%	376	324	99	782	195.44	324	1464	1263
5:15-5:30	29%	414	357	132	914	228.49	357	1507	1300
5:30-5:45	24%	342	295	70	984	246.01	295	1501	1295
5:45-6:00	21%	292	252	27	1011	252.74	252	1424	1229
6:00-6:15	28%	342	295	70	1081	270.26	295	1390	1199
6:15-6:30	26%	311	268	43	1124	281.10	268	1287	1110
6:30-6:45	25%	307	265	40	1164	291.07	265	1252	1080
6:45-7:00	20%	246	212	0	1152	287.88	212	1206	1041

Total Delay (veh-hr)	1,672
Total Vehicles Delayed (veh)	3,711
Average Delay (hr)	0.45
Average Delay (min)	27.04

Maximum Queue (veh)	1011
Maximum Queue (ft)	30,329

RAMP METERING ANALYSIS

Project: SR 65 Capacity & Operational Improvements
Ramp: Lincoln Blvd to Southbound SR 65
Scenario: Design Year Conditions

Configuration: 2 metered
Peak Hour Volume: 1,540
Peak Period Volume: 4,190

HOV Bypass (%)	0%
Metered Volume (veh/hr)	1,540
Metering Rate (veh/hr)	1,740
Discharge Rate (veh/15 min)	435

Storage Length (ft)	540
Storage Lanes	2
Maximum Storage (veh)	36

Time Interval	Hourly Arrival Distribution	15-Minute Volumes	Metered 15-Minute min flows	Excess Demand	Accumulated Vehicles	Total Delay (veh-hr)	Vehicles Delayed	Total Hourly Volume	Metered Hourly Volume
6:00-6:15	22%	293	293	0	0	0.00	0		
6:15-6:30	22%	289	289	0	0	0.00	0		
6:30-6:45	28%	374	374	0	0	0.00	0		
6:45-7:00	29%	386	386	0	0	0.00	0	1342	1342
7:00-7:15	19%	289	289	0	0	0.00	0	1338	1338
7:15-7:30	22%	323	323	0	0	0.00	0	1372	1372
7:30-7:45	30%	444	444	9	9	2.25	444	1442	1442
7:45-8:00	29%	435	435	0	9	2.25	435	1491	1491
8:00-8:15	29%	459	459	24	33	8.25	459	1661	1661
8:15-8:30	26%	409	409	0	7	1.75	409	1747	1747
8:30-8:45	22%	345	345	0	0	0.00	0	1648	1648
8:45-9:00	24%	382	382	0	0	0.00	0	1595	1595
9:00-9:15	26%	376	376	0	0	0.00	0	1512	1512
9:15-9:30	21%	305	305	0	0	0.00	0	1408	1408
9:30-9:45	26%	370	370	0	0	0.00	0	1433	1433
9:45-10:00	26%	368	368	0	0	0.00	0	1419	1419

Total Delay (veh-hr)	15
Total Vehicles Delayed (veh)	1,747
Average Delay (hr)	0.01
Average Delay (min)	0.50

Maximum Queue (veh)	33
Maximum Queue (ft)	495

Location: SR 65 Capacity & Operational Improvements
Ramp: Lincoln Blvd to Southbound SR 65
Scenario: Design Year Conditions

Configuration: 2 metered
Peak Hour Volume: 1,470
Peak Period Volume: 4,570

HOV Bypass (%)	0%
Metered Volume (veh/hr)	1,470
Metering Rate (veh/hr)	1,580
Discharge Rate (veh/15 min)	395

Storage Length (ft)	540
Storage Lanes	2
Maximum Storage (veh)	36

Time Interval	Hourly Arrival Distribution	15-Minute Volumes	Metered 15-Minute min flows	Excess Demand	Accumulated Vehicles	Total Delay (veh-hr)	Vehicles Delayed	Total Hourly Volume	Metered Hourly Volume
3:00-3:15	28%	380	380	0	0	0.00	0		
3:15-3:30	27%	360	360	0	0	0.00	0		
3:30-3:45	23%	312	312	0	0	0.00	0		
3:45-4:00	23%	306	306	0	0	0.00	0	1358	1358
4:00-4:15	28%	431	431	36	36	9.00	431	1409	1409
4:15-4:30	24%	371	371	0	12	3.00	371	1420	1420
4:30-4:45	23%	348	348	0	0	0.00	0	1456	1456
4:45-5:00	24%	369	369	0	0	0.00	0	1519	1519
5:00-5:15	26%	376	376	0	0	0.00	0	1464	1464
5:15-5:30	29%	414	414	19	19	4.75	414	1507	1507
5:30-5:45	24%	342	342	0	0	0.00	0	1501	1501
5:45-6:00	21%	292	292	0	0	0.00	0	1424	1424
6:00-6:15	28%	342	342	0	0	0.00	0	1390	1390
6:15-6:30	26%	311	311	0	0	0.00	0	1287	1287
6:30-6:45	25%	307	307	0	0	0.00	0	1252	1252
6:45-7:00	20%	246	246	0	0	0.00	0	1206	1206

Total Delay (veh-hr)	17
Total Vehicles Delayed (veh)	1,216
Average Delay (hr)	0.01
Average Delay (min)	0.83

Maximum Queue (veh)	36
Maximum Queue (ft)	540

RAMP METERING ANALYSIS

Project: SR 65 Capacity & Operational Improvements
Ramp: Lincoln Blvd to Southbound SR 65
Scenario: Design Year Conditions

Configuration: 2 metered + 1 HOV
Peak Hour Volume: 1,540
Peak Period Volume: 4,190

HOV Bypass (%)	19%
Metered Volume (veh/hr)	1,251
Metering Rate (veh/hr)	1,405
Discharge Rate (veh/15 min)	351

Storage Length (ft)	540
Storage Lanes	2
Maximum Storage (veh)	36

Time Interval	Hourly Arrival Distribution	15-Minute Volumes	Metered 15-Minute min flows	Excess Demand	Accumulated Vehicles	Total Delay (veh-hr)	Vehicles Delayed	Total Hourly Volume	Metered Hourly Volume
6:00-6:15	22%	293	238	0	0	0.00	0		
6:15-6:30	22%	289	235	0	0	0.00	0		
6:30-6:45	28%	374	304	0	0	0.00	0		
6:45-7:00	29%	386	314	0	0	0.00	0	1342	1091
7:00-7:15	19%	289	235	0	0	0.00	0	1338	1087
7:15-7:30	22%	323	262	0	0	0.00	0	1372	1115
7:30-7:45	30%	444	361	10	10	2.39	361	1442	1172
7:45-8:00	29%	435	354	2	12	2.95	354	1491	1212
8:00-8:15	29%	459	373	22	34	8.39	373	1661	1350
8:15-8:30	26%	409	332	0	15	3.67	332	1747	1420
8:30-8:45	22%	345	280	0	0	0.00	0	1648	1339
8:45-9:00	24%	382	310	0	0	0.00	0	1595	1296
9:00-9:15	26%	376	306	0	0	0.00	0	1512	1229
9:15-9:30	21%	305	248	0	0	0.00	0	1408	1144
9:30-9:45	26%	370	301	0	0	0.00	0	1433	1165
9:45-10:00	26%	368	299	0	0	0.00	0	1419	1153

Total Delay (veh-hr)	17
Total Vehicles Delayed (veh)	1,420
Average Delay (hr)	0.01
Average Delay (min)	0.74

Maximum Queue (veh)	34
Maximum Queue (ft)	504

Location: SR 65 Capacity & Operational Improvements
Ramp: Lincoln Blvd to Southbound SR 65
Scenario: Design Year Conditions

Configuration: 2 metered + 1 HOV
Peak Hour Volume: 1,470
Peak Period Volume: 4,570

HOV Bypass (%)	14%
Metered Volume (veh/hr)	1,268
Metering Rate (veh/hr)	1,345
Discharge Rate (veh/15 min)	336

Storage Length (ft)	540
Storage Lanes	2
Maximum Storage (veh)	36

Time Interval	Hourly Arrival Distribution	15-Minute Volumes	Metered 15-Minute min flows	Excess Demand	Accumulated Vehicles	Total Delay (veh-hr)	Vehicles Delayed	Total Hourly Volume	Metered Hourly Volume
3:00-3:15	28%	380	328	0	0	0.00	0		
3:15-3:30	27%	360	311	0	0	0.00	0		
3:30-3:45	23%	312	269	0	0	0.00	0		
3:45-4:00	23%	306	264	0	0	0.00	0	1358	1172
4:00-4:15	28%	431	372	36	36	8.91	372	1409	1216
4:15-4:30	24%	371	320	0	19	4.87	320	1420	1225
4:30-4:45	23%	348	300	0	0	0.00	0	1456	1256
4:45-5:00	24%	369	318	0	0	0.00	0	1519	1311
5:00-5:15	26%	376	324	0	0	0.00	0	1464	1263
5:15-5:30	29%	414	357	21	21	5.24	357	1507	1300
5:30-5:45	24%	342	295	0	0	0.00	0	1501	1295
5:45-6:00	21%	292	252	0	0	0.00	0	1424	1229
6:00-6:15	28%	342	295	0	0	0.00	0	1390	1199
6:15-6:30	26%	311	268	0	0	0.00	0	1287	1110
6:30-6:45	25%	307	265	0	0	0.00	0	1252	1080
6:45-7:00	20%	246	212	0	0	0.00	0	1206	1041

Total Delay (veh-hr)	19
Total Vehicles Delayed (veh)	1,049
Average Delay (hr)	0.02
Average Delay (min)	1.09

Maximum Queue (veh)	36
Maximum Queue (ft)	534

RAMP METERING ANALYSIS

Project: SR 65 Capacity & Operational Improvements
Ramp: Twelve Bridges Dr to Southbound SR 65
Scenario: Design Year Conditions

Configuration: 1 metered + 1 HOV
Peak Hour Volume: 1,070
Peak Period Volume: 3,470

HOV Bypass (%)	17%
Metered Volume (veh/hr)	888
Metering Rate (veh/hr)	900
Discharge Rate (veh/15 min)	225

Storage Length (ft)	590
Storage Lanes	1
Maximum Storage (veh)	20

Time Interval	Hourly Arrival Distribution	15-Minute Volumes	Metered 15-Minute min flows	Excess Demand	Accumulated Vehicles	Total Delay (veh-hr)	Vehicles Delayed	Total Hourly Volume	Metered Hourly Volume
6:00-6:15	22%	112	93	0	0	0.00	0		
6:15-6:30	22%	110	91	0	0	0.00	0		
6:30-6:45	28%	143	119	0	0	0.00	0		
6:45-7:00	29%	148	123	0	0	0.00	0	513	426
7:00-7:15	17%	172	143	0	0	0.00	0	573	475
7:15-7:30	24%	247	205	0	0	0.00	0	710	589
7:30-7:45	30%	309	256	31	31	7.83	256	876	727
7:45-8:00	30%	315	261	36	68	16.90	261	1043	865
8:00-8:15	32%	348	289	64	131	32.81	289	1219	1011
8:15-8:30	23%	256	212	0	119	29.65	212	1228	1019
8:30-8:45	24%	258	214	0	108	26.90	214	1177	976
8:45-9:00	21%	231	192	0	74	18.55	192	1093	907
9:00-9:15	26%	278	231	6	80	19.95	231	1023	849
9:15-9:30	21%	225	187	0	41	10.36	187	992	823
9:30-9:45	26%	274	227	2	44	10.93	227	1008	836
9:45-10:00	26%	272	226	1	44	11.09	226	1049	870

Total Delay (veh-hr)	185
Total Vehicles Delayed (veh)	2,294
Average Delay (hr)	0.08
Average Delay (min)	4.84

Maximum Queue (veh)	131
Maximum Queue (ft)	3,938

Location: SR 65 Capacity & Operational Improvements
Ramp: Twelve Bridges Dr to Southbound SR 65
Scenario: Design Year Conditions

Configuration: 1 metered + 1 HOV
Peak Hour Volume: 940
Peak Period Volume: 3,440

HOV Bypass (%)	10%
Metered Volume (veh/hr)	844
Metering Rate (veh/hr)	900
Discharge Rate (veh/15 min)	225

Storage Length (ft)	590
Storage Lanes	1
Maximum Storage (veh)	20

Time Interval	Arrival Distribution	15-Minute Volumes	Metered 15-Minute min flows	Excess Demand	Accumulated Vehicles	Total Delay (veh-hr)	Vehicles Delayed	Total Hourly Volume	Metered Hourly Volume
3:00-3:15	28%	285	256	31	31	7.75	256		
3:15-3:30	27%	270	243	18	49	12.14	243		
3:30-3:45	23%	234	210	0	34	8.44	210		
3:45-4:00	23%	230	207	0	15	3.84	207	1019	915
4:00-4:15	29%	247	222	0	12	3.06	222	981	881
4:15-4:30	25%	213	191	0	0	0.00	0	924	830
4:30-4:45	23%	195	175	0	0	0.00	0	885	795
4:45-5:00	22%	189	170	0	0	0.00	0	844	758
5:00-5:15	33%	340	305	80	80	20.10	305	937	842
5:15-5:30	29%	303	272	47	128	31.90	272	1027	923
5:30-5:45	23%	235	211	0	114	28.42	211	1067	958
5:45-6:00	15%	158	142	0	31	7.66	142	1036	931
6:00-6:15	28%	123	110	0	0	0.00	0	819	736
6:15-6:30	26%	112	101	0	0	0.00	0	628	564
6:30-6:45	25%	110	99	0	0	0.00	0	503	452
6:45-7:00	20%	88	79	0	0	0.00	0	433	389

Total Delay (veh-hr)	123
Total Vehicles Delayed (veh)	2,068
Average Delay (hr)	0.06
Average Delay (min)	3.58

Maximum Queue (veh)	128
Maximum Queue (ft)	3,828

RAMP METERING ANALYSIS

Project: SR 65 Capacity & Operational Improvements
Ramp: Twelve Bridges Dr to Southbound SR 65
Scenario: Design Year Conditions

Configuration: 2 metered
Peak Hour Volume: 1,070
Peak Period Volume: 3,470

HOV Bypass (%)	0%
Metered Volume (veh/hr)	1,070
Metering Rate (veh/hr)	1,225
Discharge Rate (veh/15 min)	306

Storage Length (ft)	850
Storage Lanes	2
Maximum Storage (veh)	57

Time Interval	Hourly Arrival Distribution	15-Minute Volumes	Metered 15-Minute min flows	Excess Demand	Accumulated Vehicles	Total Delay (veh-hr)	Vehicles Delayed	Total Hourly Volume	Metered Hourly Volume
6:00-6:15	22%	112	112	0	0	0.00	0		
6:15-6:30	22%	110	110	0	0	0.00	0		
6:30-6:45	28%	143	143	0	0	0.00	0		
6:45-7:00	29%	148	148	0	0	0.00	0	513	513
7:00-7:15	17%	172	172	0	0	0.00	0	573	573
7:15-7:30	24%	247	247	0	0	0.00	0	710	710
7:30-7:45	30%	309	309	3	3	0.69	309	876	876
7:45-8:00	30%	315	315	9	12	2.88	315	1043	1043
8:00-8:15	32%	348	348	42	53	13.31	348	1219	1219
8:15-8:30	23%	256	256	0	3	0.75	256	1228	1228
8:30-8:45	24%	258	258	0	0	0.00	0	1177	1177
8:45-9:00	21%	231	231	0	0	0.00	0	1093	1093
9:00-9:15	26%	278	278	0	0	0.00	0	1023	1023
9:15-9:30	21%	225	225	0	0	0.00	0	992	992
9:30-9:45	26%	274	274	0	0	0.00	0	1008	1008
9:45-10:00	26%	272	272	0	0	0.00	0	1049	1049

Total Delay (veh-hr)	18
Total Vehicles Delayed (veh)	1,228
Average Delay (hr)	0.01
Average Delay (min)	0.86

Maximum Queue (veh)	53
Maximum Queue (ft)	799

Location: SR 65 Capacity & Operational Improvements
Ramp: Twelve Bridges Dr to Southbound SR 65
Scenario: Design Year Conditions

Configuration: 2 metered
Peak Hour Volume: 940
Peak Period Volume: 3,440

HOV Bypass (%)	0%
Metered Volume (veh/hr)	940
Metering Rate (veh/hr)	1,175
Discharge Rate (veh/15 min)	294

Storage Length (ft)	850
Storage Lanes	2
Maximum Storage (veh)	57

Time Interval	Arrival Distribution	15-Minute Volumes	Metered 15-Minute min flows	Excess Demand	Accumulated Vehicles	Total Delay (veh-hr)	Vehicles Delayed	Total Hourly Volume	Metered Hourly Volume
3:00-3:15	28%	285	285	0	0	0.00	0		
3:15-3:30	27%	270	270	0	0	0.00	0		
3:30-3:45	23%	234	234	0	0	0.00	0		
3:45-4:00	23%	230	230	0	0	0.00	0	1019	1019
4:00-4:15	29%	247	247	0	0	0.00	0	981	981
4:15-4:30	25%	213	213	0	0	0.00	0	924	924
4:30-4:45	23%	195	195	0	0	0.00	0	885	885
4:45-5:00	22%	189	189	0	0	0.00	0	844	844
5:00-5:15	33%	340	340	46	46	11.56	340	937	937
5:15-5:30	29%	303	303	9	56	13.88	303	1027	1027
5:30-5:45	23%	235	235	0	0	0.00	0	1067	1067
5:45-6:00	15%	158	158	0	0	0.00	0	1036	1036
6:00-6:15	28%	123	123	0	0	0.00	0	819	819
6:15-6:30	26%	112	112	0	0	0.00	0	628	628
6:30-6:45	25%	110	110	0	0	0.00	0	503	503
6:45-7:00	20%	88	88	0	0	0.00	0	433	433

Total Delay (veh-hr)	25
Total Vehicles Delayed (veh)	643
Average Delay (hr)	0.04
Average Delay (min)	2.37

Maximum Queue (veh)	56
Maximum Queue (ft)	833

RAMP METERING ANALYSIS

Project: SR 65 Capacity & Operational Improvements
Ramp: Westbound Placer Pkwy to SB SR 65
Scenario: Design Year Conditions

Configuration: 1 metered + 1 HOV
Peak Hour Volume: 370
Peak Period Volume: 1,110

HOV Bypass (%)	30%
Metered Volume (veh/hr)	257
Metering Rate (veh/hr)	360
Discharge Rate (veh/15 min)	90

Storage Length (ft)	640
Storage Lanes	1
Maximum Storage (veh)	21

Time Interval	Hourly Arrival Distribution	15-Minute Volumes	Metered 15-Minute min flows	Excess Demand	Accumulated Vehicles	Total Delay (veh-hr)	Vehicles Delayed	Total Hourly Volume	Metered Hourly Volume
6:00-6:15	18%	57	40	0	0	0.00	0		
6:15-6:30	24%	79	55	0	0	0.00	0		
6:30-6:45	28%	91	63	0	0	0.00	0		
6:45-7:00	30%	97	67	0	0	0.00	0	324	225
7:00-7:15	22%	70	49	0	0	0.00	0	337	234
7:15-7:30	26%	84	58	0	0	0.00	0	342	238
7:30-7:45	22%	70	49	0	0	0.00	0	321	223
7:45-8:00	30%	94	65	0	0	0.00	0	318	221
8:00-8:15	23%	99	69	0	0	0.00	0	347	241
8:15-8:30	33%	144	100	10	10	2.55	100	407	283
8:30-8:45	20%	88	61	0	0	0.00	0	425	296
8:45-9:00	23%	101	70	0	0	0.00	0	432	301
9:00-9:15	27%	150	104	14	14	3.59	104	483	336
9:15-9:30	24%	130	90	0	15	3.71	90	469	326
9:30-9:45	19%	106	74	0	0	0.00	0	487	339
9:45-10:00	29%	159	111	21	21	5.16	111	545	379

Total Delay (veh-hr)	15
Total Vehicles Delayed (veh)	406
Average Delay (hr)	0.04
Average Delay (min)	2.22

Maximum Queue (veh)	21
Maximum Queue (ft)	619

Location: SR 65 Capacity & Operational Improvements
Ramp: Westbound Placer Pkwy to SB SR 65
Scenario: Design Year Conditions

Configuration: 1 metered + 1 HOV
Peak Hour Volume: 390
Peak Period Volume: 1,210

HOV Bypass (%)	28%
Metered Volume (veh/hr)	280
Metering Rate (veh/hr)	340
Discharge Rate (veh/15 min)	85

Storage Length (ft)	640
Storage Lanes	1
Maximum Storage (veh)	21

Time Interval	Arrival Distribution	15-Minute Volumes	Metered 15-Minute min flows	Excess Demand	Accumulated Vehicles	Total Delay (veh-hr)	Vehicles Delayed	Total Hourly Volume	Metered Hourly Volume
3:00-3:15	24%	109	78	0	0	0.00	0		
3:15-3:30	23%	100	72	0	0	0.00	0		
3:30-3:45	32%	144	103	18	18	4.56	103		
3:45-4:00	21%	93	67	0	0	0.00	0	446	320
4:00-4:15	23%	108	77	0	0	0.00	0	445	319
4:15-4:30	21%	96	69	0	0	0.00	0	441	316
4:30-4:45	32%	147	105	20	20	5.10	105	444	318
4:45-5:00	24%	110	79	0	14	3.57	79	461	331
5:00-5:15	34%	110	79	0	8	2.03	79	463	332
5:15-5:30	24%	76	54	0	0	0.00	0	443	318
5:30-5:45	25%	81	58	0	0	0.00	0	377	270
5:45-6:00	17%	54	39	0	0	0.00	0	321	230
6:00-6:15	31%	96	69	0	0	0.00	0	307	220
6:15-6:30	24%	74	53	0	0	0.00	0	305	219
6:30-6:45	27%	85	61	0	0	0.00	0	309	222
6:45-7:00	18%	57	41	0	0	0.00	0	312	224

Total Delay (veh-hr)	15
Total Vehicles Delayed (veh)	366
Average Delay (hr)	0.04
Average Delay (min)	2.50

Maximum Queue (veh)	20
Maximum Queue (ft)	612

RAMP METERING ANALYSIS

Project: SR 65 Capacity & Operational Improvements
Ramp: Eastbound Placer Pkwy to SB SR 65
Scenario: Design Year Conditions

Configuration: 1 metered + 1 HOV
Peak Hour Volume: 570
Peak Period Volume: 1,980

HOV Bypass (%)	17%
Metered Volume (veh/hr)	472
Metering Rate (veh/hr)	650
Discharge Rate (veh/15 min)	163

Storage Length (ft)	920
Storage Lanes	1
Maximum Storage (veh)	31

Time Interval	Hourly Arrival Distribution	15-Minute Volumes	Metered 15-Minute min flows	Excess Demand	Accumulated Vehicles	Total Delay (veh-hr)	Vehicles Delayed	Total Hourly Volume	Metered Hourly Volume
6:00-6:15	26%	53	44	0	0	0.00	0		
6:15-6:30	19%	38	31	0	0	0.00	0		
6:30-6:45	26%	51	42	0	0	0.00	0		
6:45-7:00	29%	59	49	0	0	0.00	0	201	167
7:00-7:15	19%	140	116	0	0	0.00	0	288	239
7:15-7:30	25%	181	150	0	0	0.00	0	431	357
7:30-7:45	24%	174	144	0	0	0.00	0	554	459
7:45-8:00	32%	232	192	30	30	7.45	192	727	603
8:00-8:15	23%	91	75	0	0	0.00	0	678	562
8:15-8:30	27%	108	90	0	0	0.00	0	605	501
8:30-8:45	27%	108	90	0	0	0.00	0	539	447
8:45-9:00	24%	97	80	0	0	0.00	0	404	335
9:00-9:15	26%	115	95	0	0	0.00	0	428	355
9:15-9:30	25%	112	93	0	0	0.00	0	432	358
9:30-9:45	25%	113	94	0	0	0.00	0	437	362
9:45-10:00	24%	106	88	0	0	0.00	0	446	370

Total Delay (veh-hr)	7
Total Vehicles Delayed (veh)	192
Average Delay (hr)	0.04
Average Delay (min)	2.32

Maximum Queue (veh)	30
Maximum Queue (ft)	893

Location: SR 65 Capacity & Operational Improvements
Ramp: Eastbound Placer Pkwy to SB SR 65
Scenario: Design Year Conditions

Configuration: 1 metered + 1 HOV
Peak Hour Volume: 750
Peak Period Volume: 2,820

HOV Bypass (%)	23%
Metered Volume (veh/hr)	577
Metering Rate (veh/hr)	650
Discharge Rate (veh/15 min)	163

Storage Length (ft)	920
Storage Lanes	1
Maximum Storage (veh)	31

Time Interval	Arrival Distribution	15-Minute Volumes	Metered 15-Minute min flows	Excess Demand	Accumulated Vehicles	Total Delay (veh-hr)	Vehicles Delayed	Total Hourly Volume	Metered Hourly Volume
3:00-3:15	26%	225	173	11	11	2.67	173		
3:15-3:30	24%	204	157	0	5	1.30	157		
3:30-3:45	28%	241	185	23	28	7.05	185		
3:45-4:00	23%	195	150	0	16	3.95	150	865	666
4:00-4:15	28%	190	146	0	0	0.00	0	830	639
4:15-4:30	26%	175	135	0	0	0.00	0	801	617
4:30-4:45	28%	190	146	0	0	0.00	0	750	577
4:45-5:00	18%	125	96	0	0	0.00	0	680	523
5:00-5:15	27%	217	167	5	5	1.13	167	707	544
5:15-5:30	29%	235	181	18	23	5.73	181	767	590
5:30-5:45	25%	201	155	0	15	3.78	155	778	599
5:45-6:00	20%	162	125	0	0	0.00	0	815	627
6:00-6:15	24%	142	109	0	0	0.00	0	740	570
6:15-6:30	29%	169	130	0	0	0.00	0	674	519
6:30-6:45	26%	151	116	0	0	0.00	0	624	480
6:45-7:00	20%	119	92	0	0	0.00	0	581	447

Total Delay (veh-hr)	26
Total Vehicles Delayed (veh)	1,168
Average Delay (hr)	0.02
Average Delay (min)	1.31

Maximum Queue (veh)	28
Maximum Queue (ft)	846

RAMP METERING ANALYSIS

Project: SR 65 Capacity & Operational Improvements
Ramp: Westbound Sunset Blvd to SB SR 65
Scenario: Design Year Conditions

Configuration: 1 metered + 1 HOV
Peak Hour Volume: 680
Peak Period Volume: 2,030

HOV Bypass (%)	6%
Metered Volume (veh/hr)	641
Metering Rate (veh/hr)	740
Discharge Rate (veh/15 min)	185

Storage Length (ft)	595
Storage Lanes	1
Maximum Storage (veh)	20

Time Interval	Hourly Arrival Distribution	15-Minute Volumes	Metered 15-Minute min flows	Excess Demand	Accumulated Vehicles	Total Delay (veh-hr)	Vehicles Delayed	Total Hourly Volume	Metered Hourly Volume
6:00-6:15	18%	61	57	0	0	0.00	0		
6:15-6:30	24%	85	80	0	0	0.00	0		
6:30-6:45	28%	98	92	0	0	0.00	0		
6:45-7:00	30%	105	99	0	0	0.00	0	349	329
7:00-7:15	22%	162	153	0	0	0.00	0	450	424
7:15-7:30	26%	194	183	0	0	0.00	0	559	527
7:30-7:45	22%	162	153	0	0	0.00	0	623	587
7:45-8:00	30%	217	204	19	19	4.87	204	735	693
8:00-8:15	23%	143	135	0	0	0.00	0	716	675
8:15-8:30	33%	209	197	12	12	2.99	197	731	689
8:30-8:45	20%	127	120	0	0	0.00	0	696	656
8:45-9:00	23%	147	139	0	0	0.00	0	626	590
9:00-9:15	27%	120	113	0	0	0.00	0	603	568
9:15-9:30	24%	104	98	0	0	0.00	0	498	469
9:30-9:45	19%	85	80	0	0	0.00	0	456	430
9:45-10:00	29%	127	120	0	0	0.00	0	436	411

Total Delay (veh-hr)	8
Total Vehicles Delayed (veh)	401
Average Delay (hr)	0.02
Average Delay (min)	1.17

Maximum Queue (veh)	19
Maximum Queue (ft)	585

Location: SR 65 Capacity & Operational Improvements
Ramp: Westbound Sunset Blvd to SB SR 65
Scenario: Design Year Conditions

Configuration: 1 metered + 1 HOV
Peak Hour Volume: 960
Peak Period Volume: 2,970

HOV Bypass (%)	11%
Metered Volume (veh/hr)	850
Metering Rate (veh/hr)	900
Discharge Rate (veh/15 min)	225

Storage Length (ft)	595
Storage Lanes	1
Maximum Storage (veh)	20

Time Interval	Arrival Distribution	15-Minute Volumes	Metered 15-Minute min flows	Excess Demand	Accumulated Vehicles	Total Delay (veh-hr)	Vehicles Delayed	Total Hourly Volume	Metered Hourly Volume
3:00-3:15	24%	218	193	0	0	0.00	0		
3:15-3:30	23%	201	178	0	0	0.00	0		
3:30-3:45	32%	286	253	28	28	7.03	253		
3:45-4:00	21%	185	164	0	0	0.00	0	890	788
4:00-4:15	23%	205	181	0	0	0.00	0	877	776
4:15-4:30	21%	183	162	0	0	0.00	0	859	760
4:30-4:45	32%	280	248	23	23	5.70	248	853	755
4:45-5:00	24%	209	185	0	0	0.00	0	877	776
5:00-5:15	34%	356	315	90	90	22.52	315	1028	910
5:15-5:30	24%	246	218	0	83	20.70	218	1091	966
5:30-5:45	25%	260	230	5	88	21.97	230	1071	948
5:45-6:00	17%	173	153	0	16	4.00	153	1035	916
6:00-6:15	31%	219	194	0	0	0.00	0	898	795
6:15-6:30	24%	169	150	0	0	0.00	0	821	727
6:30-6:45	27%	194	172	0	0	0.00	0	755	668
6:45-7:00	18%	130	115	0	0	0.00	0	712	630

Total Delay (veh-hr)	82
Total Vehicles Delayed (veh)	1,417
Average Delay (hr)	0.06
Average Delay (min)	3.47

Maximum Queue (veh)	90
Maximum Queue (ft)	2,702

RAMP METERING ANALYSIS

Project: SR 65 Capacity & Operational Improvements
Ramp: Westbound Sunset Blvd to SB SR 65
Scenario: Design Year Conditions

Configuration: 2 metered
Peak Hour Volume: 680
Peak Period Volume: 2,030

HOV Bypass (%)	0%
Metered Volume (veh/hr)	680
Metering Rate (veh/hr)	715
Discharge Rate (veh/15 min)	179

Storage Length (ft)	595
Storage Lanes	2
Maximum Storage (veh)	40

Time Interval	Hourly Arrival Distribution	15-Minute Volumes	Metered 15-Minute min flows	Excess Demand	Accumulated Vehicles	Total Delay (veh-hr)	Vehicles Delayed	Total Hourly Volume	Metered Hourly Volume
6:00-6:15	18%	61	61	0	0	0.00	0		
6:15-6:30	24%	85	85	0	0	0.00	0		
6:30-6:45	28%	98	98	0	0	0.00	0		
6:45-7:00	30%	105	105	0	0	0.00	0	349	349
7:00-7:15	22%	162	162	0	0	0.00	0	450	450
7:15-7:30	26%	194	194	15	15	3.81	194	559	559
7:30-7:45	22%	162	162	0	0	0.00	0	623	623
7:45-8:00	30%	217	217	38	38	9.56	217	735	735
8:00-8:15	23%	143	143	0	3	0.63	143	716	716
8:15-8:30	33%	209	209	30	33	8.19	209	731	731
8:30-8:45	20%	127	127	0	0	0.00	0	696	696
8:45-9:00	23%	147	147	0	0	0.00	0	626	626
9:00-9:15	27%	120	120	0	0	0.00	0	603	603
9:15-9:30	24%	104	104	0	0	0.00	0	498	498
9:30-9:45	19%	85	85	0	0	0.00	0	456	456
9:45-10:00	29%	127	127	0	0	0.00	0	436	436

Total Delay (veh-hr)	22
Total Vehicles Delayed (veh)	763
Average Delay (hr)	0.03
Average Delay (min)	1.74

Maximum Queue (veh)	38
Maximum Queue (ft)	574

Location: SR 65 Capacity & Operational Improvements
Ramp: Westbound Sunset Blvd to SB SR 65
Scenario: Design Year Conditions

Configuration: 2 metered
Peak Hour Volume: 960
Peak Period Volume: 2,970

HOV Bypass (%)	0%
Metered Volume (veh/hr)	960
Metering Rate (veh/hr)	1,270
Discharge Rate (veh/15 min)	318

Storage Length (ft)	595
Storage Lanes	2
Maximum Storage (veh)	40

Time Interval	Arrival Distribution	15-Minute Volumes	Metered 15-Minute min flows	Excess Demand	Accumulated Vehicles	Total Delay (veh-hr)	Vehicles Delayed	Total Hourly Volume	Metered Hourly Volume
3:00-3:15	24%	218	218	0	0	0.00	0		
3:15-3:30	23%	201	201	0	0	0.00	0		
3:30-3:45	32%	286	286	0	0	0.00	0		
3:45-4:00	21%	185	185	0	0	0.00	0	890	890
4:00-4:15	23%	205	205	0	0	0.00	0	877	877
4:15-4:30	21%	183	183	0	0	0.00	0	859	859
4:30-4:45	32%	280	280	0	0	0.00	0	853	853
4:45-5:00	24%	209	209	0	0	0.00	0	877	877
5:00-5:15	34%	356	356	39	39	9.63	356	1028	1028
5:15-5:30	24%	246	246	0	0	0.00	0	1091	1091
5:30-5:45	25%	260	260	0	0	0.00	0	1071	1071
5:45-6:00	17%	173	173	0	0	0.00	0	1035	1035
6:00-6:15	31%	219	219	0	0	0.00	0	898	898
6:15-6:30	24%	169	169	0	0	0.00	0	821	821
6:30-6:45	27%	194	194	0	0	0.00	0	755	755
6:45-7:00	18%	130	130	0	0	0.00	0	712	712

Total Delay (veh-hr)	10
Total Vehicles Delayed (veh)	356
Average Delay (hr)	0.03
Average Delay (min)	1.62

Maximum Queue (veh)	39
Maximum Queue (ft)	578

RAMP METERING ANALYSIS

Project: SR 65 Capacity & Operational Improvements
Ramp: Eastbound Sunset Blvd to SB SR 65
Scenario: Design Year Conditions

Configuration: 2 metered + 1 HOV
Peak Hour Volume: 550
Peak Period Volume: 1,910

HOV Bypass (%)	14%
Metered Volume (veh/hr)	474
Metering Rate (veh/hr)	500
Discharge Rate (veh/15 min)	125

Storage Length (ft)	560
Storage Lanes	2
Maximum Storage (veh)	37

Time Interval	Hourly Arrival Distribution	15-Minute Volumes	Metered 15-Minute min flows	Excess Demand	Accumulated Vehicles	Total Delay (veh-hr)	Vehicles Delayed	Total Hourly Volume	Metered Hourly Volume
6:00-6:15	26%	112	96	0	0	0.00	0		
6:15-6:30	19%	81	70	0	0	0.00	0		
6:30-6:45	26%	109	94	0	0	0.00	0		
6:45-7:00	29%	125	108	0	0	0.00	0	427	368
7:00-7:15	19%	96	83	0	0	0.00	0	411	354
7:15-7:30	25%	124	107	0	0	0.00	0	454	391
7:30-7:45	24%	119	102	0	0	0.00	0	464	399
7:45-8:00	32%	159	137	12	12	2.97	137	498	429
8:00-8:15	23%	134	115	0	2	0.56	115	536	461
8:15-8:30	27%	160	138	13	15	3.75	138	572	492
8:30-8:45	27%	160	138	13	28	6.94	138	613	528
8:45-9:00	24%	143	123	0	26	6.47	123	597	514
9:00-9:15	26%	151	130	5	31	7.72	130	614	529
9:15-9:30	25%	147	127	2	32	8.11	127	601	517
9:30-9:45	25%	149	128	3	36	8.93	128	590	508
9:45-10:00	24%	140	121	0	31	7.81	121	587	505

Total Delay (veh-hr)	53
Total Vehicles Delayed (veh)	1,156
Average Delay (hr)	0.05
Average Delay (min)	2.76

Maximum Queue (veh)	36
Maximum Queue (ft)	536

Location: SR 65 Capacity & Operational Improvements
Ramp: Eastbound Sunset Blvd to SB SR 65
Scenario: Design Year Conditions

Configuration: 2 metered + 1 HOV
Peak Hour Volume: 750
Peak Period Volume: 2,820

HOV Bypass (%)	23%
Metered Volume (veh/hr)	577
Metering Rate (veh/hr)	640
Discharge Rate (veh/15 min)	160

Storage Length (ft)	560
Storage Lanes	2
Maximum Storage (veh)	37

Time Interval	Arrival Distribution	15-Minute Volumes	Metered 15-Minute min flows	Excess Demand	Accumulated Vehicles	Total Delay (veh-hr)	Vehicles Delayed	Total Hourly Volume	Metered Hourly Volume
3:00-3:15	26%	225	173	13	13	3.30	173		
3:15-3:30	24%	204	157	0	10	2.55	157		
3:30-3:45	28%	241	185	25	36	8.93	185		
3:45-4:00	23%	195	150	0	26	6.45	150	865	666
4:00-4:15	28%	190	146	0	12	3.01	146	830	639
4:15-4:30	26%	175	135	0	0	0.00	0	801	617
4:30-4:45	28%	190	146	0	0	0.00	0	750	577
4:45-5:00	18%	125	96	0	0	0.00	0	680	523
5:00-5:15	27%	217	167	7	7	1.76	167	707	544
5:15-5:30	29%	235	181	21	28	6.98	181	767	590
5:30-5:45	25%	201	155	0	23	5.65	155	778	599
5:45-6:00	20%	162	125	0	0	0.00	0	815	627
6:00-6:15	24%	142	109	0	0	0.00	0	740	570
6:15-6:30	29%	169	130	0	0	0.00	0	674	519
6:30-6:45	26%	151	116	0	0	0.00	0	624	480
6:45-7:00	20%	119	92	0	0	0.00	0	581	447

Total Delay (veh-hr)	39
Total Vehicles Delayed (veh)	1,315
Average Delay (hr)	0.03
Average Delay (min)	1.76

Maximum Queue (veh)	36
Maximum Queue (ft)	536

RAMP METERING ANALYSIS

Project: SR 65 Capacity & Operational Improvements
Ramp: Westbound Blue Oaks Blvd to SB SR 65
Scenario: Design Year Conditions

Configuration: 1 metered + 1 HOV
Peak Hour Volume: 530
Peak Period Volume: 1,790

HOV Bypass (%)	9%
Metered Volume (veh/hr)	481
Metering Rate (veh/hr)	510
Discharge Rate (veh/15 min)	128

Storage Length (ft)	1,140
Storage Lanes	1
Maximum Storage (veh)	38

Time Interval	Hourly Arrival Distribution	15-Minute Volumes	Metered 15-Minute min flows	Excess Demand	Accumulated Vehicles	Total Delay (veh-hr)	Vehicles Delayed	Total Hourly Volume	Metered Hourly Volume
6:00-6:15	20%	98	89	0	0	0.00	0		
6:15-6:30	21%	102	93	0	0	0.00	0		
6:30-6:45	29%	145	132	4	4	1.02	132		
6:45-7:00	30%	149	135	8	12	2.96	135	494	448
7:00-7:15	28%	138	125	0	10	2.39	125	534	485
7:15-7:30	27%	134	122	0	4	0.92	122	566	514
7:30-7:45	26%	128	116	0	0	0.00	0	549	498
7:45-8:00	19%	94	85	0	0	0.00	0	494	448
8:00-8:15	29%	162	147	20	20	4.88	147	518	470
8:15-8:30	28%	159	144	17	36	9.08	144	543	493
8:30-8:45	24%	138	125	0	34	8.52	125	553	502
8:45-9:00	19%	109	99	0	5	1.37	99	568	515
9:00-9:15	26%	77	70	0	0	0.00	0	483	438
9:15-9:30	28%	83	75	0	0	0.00	0	407	369
9:30-9:45	22%	63	57	0	0	0.00	0	332	301
9:45-10:00	24%	69	63	0	0	0.00	0	292	265

Total Delay (veh-hr)	31
Total Vehicles Delayed (veh)	1,029
Average Delay (hr)	0.03
Average Delay (min)	1.82

Maximum Queue (veh)	36
Maximum Queue (ft)	1,090

Location: SR 65 Capacity & Operational Improvements
Ramp: Westbound Blue Oaks Blvd to SB SR 65
Scenario: Design Year Conditions

Configuration: 1 metered + 1 HOV
Peak Hour Volume: 370
Peak Period Volume: 1,330

HOV Bypass (%)	2%
Metered Volume (veh/hr)	362
Metering Rate (veh/hr)	370
Discharge Rate (veh/15 min)	93

Storage Length (ft)	1,140
Storage Lanes	1
Maximum Storage (veh)	38

Time Interval	Arrival Distribution	15-Minute Volumes	Metered 15-Minute min flows	Excess Demand	Accumulated Vehicles	Total Delay (veh-hr)	Vehicles Delayed	Total Hourly Volume	Metered Hourly Volume
3:00-3:15	26%	92	90	0	0	0.00	0		
3:15-3:30	26%	92	90	0	0	0.00	0		
3:30-3:45	28%	101	99	6	6	1.59	99		
3:45-4:00	21%	74	72	0	0	0.00	0	359	351
4:00-4:15	24%	78	76	0	0	0.00	0	345	338
4:15-4:30	25%	81	79	0	0	0.00	0	334	327
4:30-4:45	25%	82	80	0	0	0.00	0	315	308
4:45-5:00	27%	87	85	0	0	0.00	0	328	321
5:00-5:15	32%	131	128	36	36	8.93	128	381	373
5:15-5:30	23%	94	92	0	35	8.81	92	394	386
5:30-5:45	21%	87	85	0	28	6.98	85	399	391
5:45-6:00	25%	104	102	9	37	9.30	102	416	407
6:00-6:15	28%	119	116	24	61	15.30	116	404	395
6:15-6:30	23%	99	97	4	66	16.40	97	409	400
6:30-6:45	26%	111	109	16	82	20.44	109	433	424
6:45-7:00	22%	93	91	0	80	20.07	91	422	413

Total Delay (veh-hr)	36
Total Vehicles Delayed (veh)	506
Average Delay (hr)	0.07
Average Delay (min)	4.22

Maximum Queue (veh)	37
Maximum Queue (ft)	1,116

RAMP METERING ANALYSIS

Project: SR 65 Capacity & Operational Improvements
Ramp: Eastbound Blue Oaks Blvd to SB SR 65
Scenario: Design Year Conditions

Configuration: 1 metered + 1 HOV
Peak Hour Volume: 1,340
Peak Period Volume: 4,810

HOV Bypass (%)	15%
Metered Volume (veh/hr)	1,137
Metering Rate (veh/hr)	900
Discharge Rate (veh/15 min)	225

Storage Length (ft)	800
Storage Lanes	1
Maximum Storage (veh)	27

Time Interval	Hourly Arrival Distribution	15-Minute Volumes	Metered 15-Minute min flows	Excess Demand	Accumulated Vehicles	Total Delay (veh-hr)	Vehicles Delayed	Total Hourly Volume	Metered Hourly Volume
6:00-6:15	19%	151	128	0	0	0.00	0		
6:15-6:30	23%	183	155	0	0	0.00	0		
6:30-6:45	30%	242	205	0	0	0.00	0		
6:45-7:00	28%	219	186	0	0	0.00	0	795	674
7:00-7:15	23%	327	277	52	52	13.09	277	971	824
7:15-7:30	27%	385	327	102	154	38.49	327	1173	995
7:30-7:45	25%	368	312	87	241	60.27	312	1299	1102
7:45-8:00	26%	371	315	90	331	82.70	315	1451	1231
8:00-8:15	22%	272	231	6	337	84.13	231	1396	1184
8:15-8:30	26%	321	272	47	384	95.95	272	1332	1130
8:30-8:45	23%	278	236	11	395	98.65	236	1242	1054
8:45-9:00	29%	362	307	82	477	119.17	307	1233	1046
9:00-9:15	30%	326	277	52	528	132.05	277	1287	1092
9:15-9:30	23%	251	213	0	516	129.02	213	1217	1032
9:30-9:45	23%	253	215	0	506	126.42	215	1192	1011
9:45-10:00	25%	272	231	6	511	127.85	231	1102	935

Total Delay (veh-hr)	1,108
Total Vehicles Delayed (veh)	3,211
Average Delay (hr)	0.34
Average Delay (min)	20.70

Maximum Queue (veh)	528
Maximum Queue (ft)	15,846

Location: SR 65 Capacity & Operational Improvements
Ramp: Eastbound Blue Oaks Blvd to SB SR 65
Scenario: Design Year Conditions

Configuration: 1 metered + 1 HOV
Peak Hour Volume: 1,420
Peak Period Volume: 5,050

HOV Bypass (%)	13%
Metered Volume (veh/hr)	1,238
Metering Rate (veh/hr)	900
Discharge Rate (veh/15 min)	225

Storage Length (ft)	800
Storage Lanes	1
Maximum Storage (veh)	27

Time Interval	Arrival Distribution	15-Minute Volumes	Metered 15-Minute min flows	Excess Demand	Accumulated Vehicles	Total Delay (veh-hr)	Vehicles Delayed	Total Hourly Volume	Metered Hourly Volume
3:00-3:15	23%	353	308	83	83	20.67	308		
3:15-3:30	24%	368	321	96	178	44.60	321		
3:30-3:45	27%	412	359	134	312	78.12	359		
3:45-4:00	25%	372	324	99	412	102.92	324	1505	1312
4:00-4:15	26%	366	319	94	506	126.42	319	1518	1323
4:15-4:30	25%	346	302	77	582	145.56	302	1496	1304
4:30-4:45	26%	368	321	96	678	169.49	321	1452	1266
4:45-5:00	23%	319	278	53	731	182.75	278	1399	1219
5:00-5:15	29%	421	367	142	873	218.23	367	1454	1267
5:15-5:30	24%	342	298	73	946	236.50	298	1450	1264
5:30-5:45	25%	367	320	95	1041	260.22	320	1449	1263
5:45-6:00	22%	317	276	51	1092	273.04	276	1447	1261
6:00-6:15	26%	366	319	94	1186	296.54	319	1392	1213
6:15-6:30	32%	439	383	158	1344	335.94	383	1489	1298
6:30-6:45	24%	328	286	61	1405	351.16	286	1450	1264
6:45-7:00	19%	257	224	0	1404	350.90	224	1390	1211

Total Delay (veh-hr)	1,859
Total Vehicles Delayed (veh)	3,792
Average Delay (hr)	0.49
Average Delay (min)	29.41

Maximum Queue (veh)	1092
Maximum Queue (ft)	32,765

RAMP METERING ANALYSIS

Project: SR 65 Capacity & Operational Improvements
Ramp: Eastbound Blue Oaks Blvd to SB SR 65
Scenario: Design Year Conditions

Configuration: 2 metered + 1 HOV
Peak Hour Volume: 1,340
Peak Period Volume: 4,810

HOV Bypass (%)	15%
Metered Volume (veh/hr)	1,137
Metering Rate (veh/hr)	1,205
Discharge Rate (veh/15 min)	301

Storage Length (ft)	800
Storage Lanes	2
Maximum Storage (veh)	53

Time Interval	Hourly Arrival Distribution	15-Minute Volumes	Metered 15-Minute min flows	Excess Demand	Accumulated Vehicles	Total Delay (veh-hr)	Vehicles Delayed	Total Hourly Volume	Metered Hourly Volume
6:00-6:15	19%	151	128	0	0	0.00	0		
6:15-6:30	23%	183	155	0	0	0.00	0		
6:30-6:45	30%	242	205	0	0	0.00	0		
6:45-7:00	28%	219	186	0	0	0.00	0	795	674
7:00-7:15	23%	327	277	0	0	0.00	0	971	824
7:15-7:30	27%	385	327	25	25	6.33	327	1173	995
7:30-7:45	25%	368	312	11	36	9.06	312	1299	1102
7:45-8:00	26%	371	315	13	50	12.42	315	1451	1231
8:00-8:15	22%	272	231	0	0	0.00	0	1396	1184
8:15-8:30	26%	321	272	0	0	0.00	0	1332	1130
8:30-8:45	23%	278	236	0	0	0.00	0	1242	1054
8:45-9:00	29%	362	307	6	6	1.45	307	1233	1046
9:00-9:15	30%	326	277	0	0	0.00	0	1287	1092
9:15-9:30	23%	251	213	0	0	0.00	0	1217	1032
9:30-9:45	23%	253	215	0	0	0.00	0	1192	1011
9:45-10:00	25%	272	231	0	0	0.00	0	1102	935

Total Delay (veh-hr)	29
Total Vehicles Delayed (veh)	1,260
Average Delay (hr)	0.02
Average Delay (min)	1.39

Maximum Queue (veh)	50
Maximum Queue (ft)	745

Location: SR 65 Capacity & Operational Improvements
Ramp: Eastbound Blue Oaks Blvd to SB SR 65
Scenario: Design Year Conditions

Configuration: 2 metered + 1 HOV
Peak Hour Volume: 1,420
Peak Period Volume: 5,050

HOV Bypass (%)	13%
Metered Volume (veh/hr)	1,238
Metering Rate (veh/hr)	1,270
Discharge Rate (veh/15 min)	318

Storage Length (ft)	800
Storage Lanes	2
Maximum Storage (veh)	53

Time Interval	Arrival Distribution	15-Minute Volumes	Metered 15-Minute min flows	Excess Demand	Accumulated Vehicles	Total Delay (veh-hr)	Vehicles Delayed	Total Hourly Volume	Metered Hourly Volume
3:00-3:15	23%	353	308	0	0	0.00	0		
3:15-3:30	24%	368	321	3	3	0.81	321		
3:30-3:45	27%	412	359	42	45	11.20	359		
3:45-4:00	25%	372	324	7	52	12.88	324	1505	1312
4:00-4:15	26%	366	319	1	53	13.26	319	1518	1323
4:15-4:30	25%	346	302	0	37	9.27	302	1496	1304
4:30-4:45	26%	368	321	3	40	10.08	321	1452	1266
4:45-5:00	23%	319	278	0	1	0.21	278	1399	1219
5:00-5:15	29%	421	367	49	50	12.57	367	1454	1267
5:15-5:30	24%	342	298	0	31	7.71	298	1450	1264
5:30-5:45	25%	367	320	2	33	8.30	320	1449	1263
5:45-6:00	22%	317	276	0	0	0.00	0	1447	1261
6:00-6:15	26%	366	319	1	1	0.37	319	1392	1213
6:15-6:30	32%	439	383	65	67	16.65	383	1489	1298
6:30-6:45	24%	328	286	0	35	8.74	286	1450	1264
6:45-7:00	19%	257	224	0	0	0.00	0	1390	1211

Total Delay (veh-hr)	86
Total Vehicles Delayed (veh)	3,208
Average Delay (hr)	0.03
Average Delay (min)	1.61

Maximum Queue (veh)	53
Maximum Queue (ft)	795

RAMP METERING ANALYSIS

Project: SR 65 Capacity & Operational Improvements
Ramp: WB Pleasant Grove Blvd to SB SR 65
Scenario: Design Year Conditions

Configuration: 1 metered + 1 HOV
Peak Hour Volume: 740
Peak Period Volume: 2,940

HOV Bypass (%)	28%
Metered Volume (veh/hr)	534
Metering Rate (veh/hr)	565
Discharge Rate (veh/15 min)	141

Storage Length (ft)	650
Storage Lanes	1
Maximum Storage (veh)	22

Time Interval	Hourly Arrival Distribution	15-Minute Volumes	Metered 15-Minute min flows	Excess Demand	Accumulated Vehicles	Total Delay (veh-hr)	Vehicles Delayed	Total Hourly Volume	Metered Hourly Volume
6:00-6:15	19%	115	83	0	0	0.00	0		
6:15-6:30	23%	137	99	0	0	0.00	0		
6:30-6:45	25%	147	106	0	0	0.00	0		
6:45-7:00	33%	195	141	0	0	0.00	0	594	428
7:00-7:15	25%	202	146	4	4	1.10	146	681	491
7:15-7:30	26%	205	148	7	11	2.73	148	749	540
7:30-7:45	26%	205	148	7	17	4.37	148	807	582
7:45-8:00	23%	183	132	0	8	2.04	132	795	573
8:00-8:15	23%	155	112	0	0	0.00	0	748	539
8:15-8:30	26%	180	130	0	0	0.00	0	723	521
8:30-8:45	23%	157	113	0	0	0.00	0	675	487
8:45-9:00	28%	193	139	0	0	0.00	0	685	494
9:00-9:15	29%	152	110	0	0	0.00	0	682	492
9:15-9:30	29%	156	112	0	0	0.00	0	658	474
9:30-9:45	21%	112	81	0	0	0.00	0	613	442
9:45-10:00	21%	113	81	0	0	0.00	0	533	384

Total Delay (veh-hr)	10
Total Vehicles Delayed (veh)	573
Average Delay (hr)	0.02
Average Delay (min)	1.07

Maximum Queue (veh)	17
Maximum Queue (ft)	524

Location: SR 65 Capacity & Operational Improvements
Ramp: WB Pleasant Grove Blvd to SB SR 65
Scenario: Design Year Conditions

Configuration: 1 metered + 1 HOV
Peak Hour Volume: 640
Peak Period Volume: 2,630

HOV Bypass (%)	27%
Metered Volume (veh/hr)	464
Metering Rate (veh/hr)	490
Discharge Rate (veh/15 min)	123

Storage Length (ft)	650
Storage Lanes	1
Maximum Storage (veh)	22

Time Interval	Arrival Distribution	15-Minute Volumes	Metered 15-Minute min flows	Excess Demand	Accumulated Vehicles	Total Delay (veh-hr)	Vehicles Delayed	Total Hourly Volume	Metered Hourly Volume
3:00-3:15	25%	165	120	0	0	0.00	0		
3:15-3:30	29%	191	139	16	16	4.02	139		
3:30-3:45	20%	132	96	0	0	0.00	0		
3:45-4:00	25%	165	120	0	0	0.00	0	653	474
4:00-4:15	25%	172	125	2	2	0.57	125	660	479
4:15-4:30	23%	163	118	0	0	0.00	0	632	459
4:30-4:45	24%	167	121	0	0	0.00	0	667	484
4:45-5:00	28%	198	144	21	21	5.29	144	700	508
5:00-5:15	24%	142	103	0	2	0.42	103	670	486
5:15-5:30	25%	146	106	0	0	0.00	0	653	474
5:30-5:45	24%	138	100	0	0	0.00	0	624	453
5:45-6:00	27%	156	113	0	0	0.00	0	582	422
6:00-6:15	24%	135	98	0	0	0.00	0	575	417
6:15-6:30	26%	151	110	0	0	0.00	0	580	421
6:30-6:45	27%	153	111	0	0	0.00	0	595	432
6:45-7:00	24%	135	98	0	0	0.00	0	574	416

Total Delay (veh-hr)	10
Total Vehicles Delayed (veh)	510
Average Delay (hr)	0.02
Average Delay (min)	1.21

Maximum Queue (veh)	21
Maximum Queue (ft)	634

RAMP METERING ANALYSIS

Project: SR 65 Capacity & Operational Improvements
Ramp: EB Pleasant Grove Blvd to SB SR 65
Scenario: Design Year Conditions

Configuration: 1 metered + 1 HOV
Peak Hour Volume: 810
Peak Period Volume: 2,790

HOV Bypass (%)	16%
Metered Volume (veh/hr)	677
Metering Rate (veh/hr)	700
Discharge Rate (veh/15 min)	175

Storage Length (ft)	900
Storage Lanes	1
Maximum Storage (veh)	30

Time Interval	Hourly Arrival Distribution	15-Minute Volumes	Metered 15-Minute min flows	Excess Demand	Accumulated Vehicles	Total Delay (veh-hr)	Vehicles Delayed	Total Hourly Volume	Metered Hourly Volume
6:00-6:15	18%	57	48	0	0	0.00	0		
6:15-6:30	23%	75	63	0	0	0.00	0		
6:30-6:45	31%	100	84	0	0	0.00	0		
6:45-7:00	29%	93	78	0	0	0.00	0	325	272
7:00-7:15	23%	192	161	0	0	0.00	0	460	385
7:15-7:30	28%	227	190	15	15	3.71	190	612	512
7:30-7:45	25%	206	172	0	12	3.03	172	718	600
7:45-8:00	24%	194	162	0	0	0.00	0	819	685
8:00-8:15	27%	211	176	1	1	0.37	176	838	701
8:15-8:30	24%	191	160	0	0	0.00	0	802	671
8:30-8:45	24%	194	162	0	0	0.00	0	790	661
8:45-9:00	25%	197	165	0	0	0.00	0	793	663
9:00-9:15	35%	244	204	29	29	7.27	204	826	691
9:15-9:30	24%	169	141	0	0	0.00	0	804	672
9:30-9:45	24%	164	137	0	0	0.00	0	774	647
9:45-10:00	17%	116	97	0	0	0.00	0	693	580

Total Delay (veh-hr)	14
Total Vehicles Delayed (veh)	743
Average Delay (hr)	0.02
Average Delay (min)	1.16

Maximum Queue (veh)	29
Maximum Queue (ft)	872

Location: SR 65 Capacity & Operational Improvements
Ramp: EB Pleasant Grove Blvd to SB SR 65
Scenario: Design Year Conditions

Configuration: 1 metered + 1 HOV
Peak Hour Volume: 1,190
Peak Period Volume: 4,620

HOV Bypass (%)	19%
Metered Volume (veh/hr)	960
Metering Rate (veh/hr)	900
Discharge Rate (veh/15 min)	225

Storage Length (ft)	900
Storage Lanes	1
Maximum Storage (veh)	30

Time Interval	Arrival Distribution	15-Minute Volumes	Metered 15-Minute min flows	Excess Demand	Accumulated Vehicles	Total Delay (veh-hr)	Vehicles Delayed	Total Hourly Volume	Metered Hourly Volume
3:00-3:15	25%	281	227	2	2	0.44	227		
3:15-3:30	25%	275	222	0	0	0.00	0		
3:30-3:45	23%	258	208	0	0	0.00	0		
3:45-4:00	26%	293	236	11	11	2.86	236	1107	893
4:00-4:15	24%	272	219	0	6	1.48	219	1098	886
4:15-4:30	30%	340	274	49	55	13.82	274	1163	938
4:30-4:45	23%	264	213	0	43	10.83	213	1169	943
4:45-5:00	23%	264	213	0	31	7.83	213	1140	920
5:00-5:15	28%	350	282	57	89	22.19	282	1218	983
5:15-5:30	27%	332	268	43	132	32.92	268	1210	976
5:30-5:45	22%	271	219	0	125	31.34	219	1217	982
5:45-6:00	24%	296	239	14	139	34.80	239	1249	1008
6:00-6:15	27%	231	186	0	101	25.15	186	1130	912
6:15-6:30	28%	238	192	0	68	16.91	192	1036	836
6:30-6:45	23%	194	157	0	0	0.00	0	959	774
6:45-7:00	22%	182	147	0	0	0.00	0	845	682

Total Delay (veh-hr)	159
Total Vehicles Delayed (veh)	2,391
Average Delay (hr)	0.07
Average Delay (min)	3.98

Maximum Queue (veh)	139
Maximum Queue (ft)	4,176

RAMP METERING ANALYSIS

Project: SR 65 Capacity & Operational Improvements
Ramp: EB Pleasant Grove Blvd to SB SR 65
Scenario: Design Year Conditions

Configuration: 2 metered
Peak Hour Volume: 810
Peak Period Volume: 2,790

HOV Bypass (%)	0%
Metered Volume (veh/hr)	810
Metering Rate (veh/hr)	805
Discharge Rate (veh/15 min)	201

Storage Length (ft)	900
Storage Lanes	2
Maximum Storage (veh)	60

Time Interval	Hourly Arrival Distribution	15-Minute Volumes	Metered 15-Minute min flows	Excess Demand	Accumulated Vehicles	Total Delay (veh-hr)	Vehicles Delayed	Total Hourly Volume	Metered Hourly Volume
6:00-6:15	18%	57	57	0	0	0.00	0		
6:15-6:30	23%	75	75	0	0	0.00	0		
6:30-6:45	31%	100	100	0	0	0.00	0		
6:45-7:00	29%	93	93	0	0	0.00	0	325	325
7:00-7:15	23%	192	192	0	0	0.00	0	460	460
7:15-7:30	28%	227	227	26	26	6.44	227	612	612
7:30-7:45	25%	206	206	5	31	7.63	206	718	718
7:45-8:00	24%	194	194	0	23	5.81	194	819	819
8:00-8:15	27%	211	211	10	33	8.25	211	838	838
8:15-8:30	24%	191	191	0	23	5.69	191	802	802
8:30-8:45	24%	194	194	0	16	3.88	194	790	790
8:45-9:00	25%	197	197	0	11	2.81	197	793	793
9:00-9:15	35%	244	244	43	54	13.50	244	826	826
9:15-9:30	24%	169	169	0	22	5.44	169	804	804
9:30-9:45	24%	164	164	0	0	0.00	0	774	774
9:45-10:00	17%	116	116	0	0	0.00	0	693	693

Total Delay (veh-hr)	59
Total Vehicles Delayed (veh)	1,833
Average Delay (hr)	0.03
Average Delay (min)	1.95

Maximum Queue (veh)	54
Maximum Queue (ft)	810

Location: SR 65 Capacity & Operational Improvements
Ramp: EB Pleasant Grove Blvd to SB SR 65
Scenario: Design Year Conditions

Configuration: 2 metered
Peak Hour Volume: 1,190
Peak Period Volume: 4,620

HOV Bypass (%)	0%
Metered Volume (veh/hr)	1,190
Metering Rate (veh/hr)	1,245
Discharge Rate (veh/15 min)	311

Storage Length (ft)	900
Storage Lanes	2
Maximum Storage (veh)	60

Time Interval	Arrival Distribution	15-Minute Volumes	Metered 15-Minute min flows	Excess Demand	Accumulated Vehicles	Total Delay (veh-hr)	Vehicles Delayed	Total Hourly Volume	Metered Hourly Volume
3:00-3:15	25%	281	281	0	0	0.00	0		
3:15-3:30	25%	275	275	0	0	0.00	0		
3:30-3:45	23%	258	258	0	0	0.00	0		
3:45-4:00	26%	293	293	0	0	0.00	0	1107	1107
4:00-4:15	24%	272	272	0	0	0.00	0	1098	1098
4:15-4:30	30%	340	340	29	29	7.19	340	1163	1163
4:30-4:45	23%	264	264	0	0	0.00	0	1169	1169
4:45-5:00	23%	264	264	0	0	0.00	0	1140	1140
5:00-5:15	28%	350	350	39	39	9.69	350	1218	1218
5:15-5:30	27%	332	332	21	60	14.88	332	1210	1210
5:30-5:45	22%	271	271	0	19	4.81	271	1217	1217
5:45-6:00	24%	296	296	0	4	1.00	296	1249	1249
6:00-6:15	27%	231	231	0	0	0.00	0	1130	1130
6:15-6:30	28%	238	238	0	0	0.00	0	1036	1036
6:30-6:45	23%	194	194	0	0	0.00	0	959	959
6:45-7:00	22%	182	182	0	0	0.00	0	845	845

Total Delay (veh-hr)	38
Total Vehicles Delayed (veh)	1,589
Average Delay (hr)	0.02
Average Delay (min)	1.42

Maximum Queue (veh)	60
Maximum Queue (ft)	893

RAMP METERING ANALYSIS

Project: SR 65 Capacity & Operational Improvements
Ramp: EB Pleasant Grove Blvd to SB SR 65
Scenario: Design Year Conditions

Configuration: 2 metered + 1 HOV
Peak Hour Volume: 810
Peak Period Volume: 2,790

HOV Bypass (%)	16%
Metered Volume (veh/hr)	677
Metering Rate (veh/hr)	670
Discharge Rate (veh/15 min)	168

Storage Length (ft)	900
Storage Lanes	2
Maximum Storage (veh)	60

Time Interval	Hourly Arrival Distribution	15-Minute Volumes	Metered 15-Minute min flows	Excess Demand	Accumulated Vehicles	Total Delay (veh-hr)	Vehicles Delayed	Total Hourly Volume	Metered Hourly Volume
6:00-6:15	18%	57	48	0	0	0.00	0		
6:15-6:30	23%	75	63	0	0	0.00	0		
6:30-6:45	31%	100	84	0	0	0.00	0		
6:45-7:00	29%	93	78	0	0	0.00	0	325	272
7:00-7:15	23%	192	161	0	0	0.00	0	460	385
7:15-7:30	28%	227	190	22	22	5.59	190	612	512
7:30-7:45	25%	206	172	5	27	6.78	172	718	600
7:45-8:00	24%	194	162	0	22	5.47	162	819	685
8:00-8:15	27%	211	176	9	31	7.71	176	838	701
8:15-8:30	24%	191	160	0	23	5.77	160	802	671
8:30-8:45	24%	194	162	0	18	4.46	162	790	661
8:45-9:00	25%	197	165	0	15	3.78	165	793	663
9:00-9:15	35%	244	204	37	52	12.92	204	826	691
9:15-9:30	24%	169	141	0	26	6.38	141	804	672
9:30-9:45	24%	164	137	0	0	0.00	0	774	647
9:45-10:00	17%	116	97	0	0	0.00	0	693	580

Total Delay (veh-hr)	59
Total Vehicles Delayed (veh)	1,533
Average Delay (hr)	0.04
Average Delay (min)	2.30

Maximum Queue (veh)	52
Maximum Queue (ft)	775

Location: SR 65 Capacity & Operational Improvements
Ramp: EB Pleasant Grove Blvd to SB SR 65
Scenario: Design Year Conditions

Configuration: 2 metered + 1 HOV
Peak Hour Volume: 1,190
Peak Period Volume: 4,620

HOV Bypass (%)	19%
Metered Volume (veh/hr)	960
Metering Rate (veh/hr)	985
Discharge Rate (veh/15 min)	246

Storage Length (ft)	900
Storage Lanes	2
Maximum Storage (veh)	60

Time Interval	Arrival Distribution	15-Minute Volumes	Metered 15-Minute min flows	Excess Demand	Accumulated Vehicles	Total Delay (veh-hr)	Vehicles Delayed	Total Hourly Volume	Metered Hourly Volume
3:00-3:15	25%	281	227	0	0	0.00	0		
3:15-3:30	25%	275	222	0	0	0.00	0		
3:30-3:45	23%	258	208	0	0	0.00	0		
3:45-4:00	26%	293	236	0	0	0.00	0	1107	893
4:00-4:15	24%	272	219	0	0	0.00	0	1098	886
4:15-4:30	30%	340	274	28	28	7.03	274	1163	938
4:30-4:45	23%	264	213	0	0	0.00	0	1169	943
4:45-5:00	23%	264	213	0	0	0.00	0	1140	920
5:00-5:15	28%	350	282	36	36	9.04	282	1218	983
5:15-5:30	27%	332	268	22	58	14.46	268	1210	976
5:30-5:45	22%	271	219	0	30	7.56	219	1217	982
5:45-6:00	24%	296	239	0	23	5.72	239	1249	1008
6:00-6:15	27%	231	186	0	0	0.00	0	1130	912
6:15-6:30	28%	238	192	0	0	0.00	0	1036	836
6:30-6:45	23%	194	157	0	0	0.00	0	959	774
6:45-7:00	22%	182	147	0	0	0.00	0	845	682

Total Delay (veh-hr)	44
Total Vehicles Delayed (veh)	1,282
Average Delay (hr)	0.03
Average Delay (min)	2.05

Maximum Queue (veh)	58
Maximum Queue (ft)	867

RAMP METERING ANALYSIS

Project: Stanford Ranch Rd/SR 65 Northbound Ramps
Ramp: Galleria Boulevard to Southbound SR 65
Scenario: Build Alternative Design Year Conditions

Configuration: 1 metered + 1 HOV
Peak Hour Volume: 720
Peak Period Volume: 2,420

HOV Bypass (%)	21%
Metered Volume (veh/hr)	568
Metering Rate (veh/hr)	645
Discharge Rate (veh/15 min)	161

Storage Length (ft)	640
Storage Lanes	1
Maximum Storage (veh)	21

Time Interval	Hourly Arrival Distribution	Estimated 15-Minute Volumes	Metered 15-Minute min flows	Excess Demand	Accumulated Vehicles	Total Delay (veh-hr)	Vehicles Delayed	Total Hourly Volume	Metered Hourly Volume
6:00-6:15	18%	92	73	0	0	0.00	0		
6:15-6:30	20%	101	80	0	0	0.00	0		
6:30-6:45	29%	144	114	0	0	0.00	0		
6:45-7:00	33%	164	129	0	0	0.00	0	501	395
7:00-7:15	25%	196	155	0	0	0.00	0	605	477
7:15-7:30	21%	164	129	0	0	0.00	0	668	527
7:30-7:45	26%	207	163	2	2	0.53	163	731	577
7:45-8:00	29%	227	179	18	20	5.01	179	794	627
8:00-8:15	26%	168	133	0	0	0.00	0	766	605
8:15-8:30	27%	172	136	0	0	0.00	0	774	611
8:30-8:45	23%	148	117	0	0	0.00	0	715	564
8:45-9:00	24%	155	122	0	0	0.00	0	643	507
9:00-9:15	27%	164	129	0	0	0.00	0	639	504
9:15-9:30	23%	139	110	0	0	0.00	0	606	478
9:30-9:45	26%	154	122	0	0	0.00	0	612	483
9:45-10:00	24%	147	116	0	0	0.00	0	604	477

Total Delay (veh-hr)	6
Total Vehicles Delayed (veh)	343
Average Delay (hr)	0.02
Average Delay (min)	0.97

Maximum Queue (veh)	20
Maximum Queue (ft)	601

Project: Stanford Ranch Rd/SR 65 Northbound Ramps
Ramp: Galleria Boulevard to Southbound SR 65
Scenario: Build Alternative Design Year Conditions

Configuration: 1 metered + 1 HOV
Peak Hour Volume: 1,210
Peak Period Volume: 4,670

HOV Bypass (%)	15%
Metered Volume (veh/hr)	1,031
Metering Rate (veh/hr)	900
Discharge Rate (veh/15 min)	225

Storage Length (ft)	640
Storage Lanes	1
Maximum Storage (veh)	21

Time Interval	Hourly Arrival Distribution	Estimated 15-Minute Volumes	Metered 15-Minute min flows	Excess Demand	Accumulated Vehicles	Total Delay (veh-hr)	Vehicles Delayed	Total Hourly Volume	Metered Hourly Volume
3:00-3:15	25%	310	264	39	39	9.79	264		
3:15-3:30	24%	305	260	35	74	18.51	260		
3:30-3:45	25%	317	270	45	119	29.79	270		
3:45-4:00	26%	330	281	56	175	43.84	281	1262	1075
4:00-4:15	25%	324	276	51	226	56.61	276	1276	1087
4:15-4:30	25%	321	274	49	275	68.75	274	1292	1101
4:30-4:45	26%	337	287	62	337	84.29	287	1312	1118
4:45-5:00	25%	321	274	49	386	96.42	274	1303	1110
5:00-5:15	27%	303	258	33	419	104.72	258	1282	1092
5:15-5:30	25%	274	233	8	427	106.84	233	1235	1052
5:30-5:45	24%	268	228	3	431	107.68	228	1166	994
5:45-3:00	24%	267	228	3	433	108.31	228	1112	948
3:00-3:15	26%	288	245	20	454	113.41	245	1097	935
3:15-3:30	26%	285	243	18	471	117.87	243	1108	944
3:30-3:45	27%	293	250	25	496	124.04	250	1133	965
3:45-4:00	20%	222	189	0	460	115.08	189	1088	927

Total Delay (veh-hr)	836
Total Vehicles Delayed (veh)	3,133
Average Delay (hr)	0.27
Average Delay (min)	16.00

Maximum Queue (veh)	433
Maximum Queue (ft)	12,997

RAMP METERING ANALYSIS

Project: Stanford Ranch Rd/SR 65 Northbound Ramps
Ramp: Galleria Boulevard to Southbound SR 65
Scenario: Build Alternative Design Year Conditions

Configuration: 2 metered + 1 HOV
Peak Hour Volume: 720
Peak Period Volume: 2,420

HOV Bypass (%)	21%
Metered Volume (veh/hr)	568
Metering Rate (veh/hr)	600
Discharge Rate (veh/15 min)	150

Storage Length (ft)	640
Storage Lanes	2
Maximum Storage (veh)	43

Time Interval	Hourly Arrival Distribution	Estimated 15-Minute Volumes	Metered 15-Minute min flows	Excess Demand	Accumulated Vehicles	Total Delay (veh-hr)	Vehicles Delayed	Total Hourly Volume	Metered Hourly Volume
6:00-6:15	18%	92	73	0	0	0.00	0		
6:15-6:30	20%	101	80	0	0	0.00	0		
6:30-6:45	29%	144	114	0	0	0.00	0		
6:45-7:00	33%	164	129	0	0	0.00	0	501	395
7:00-7:15	25%	196	155	5	5	1.17	155	605	477
7:15-7:30	21%	164	129	0	0	0.00	0	668	527
7:30-7:45	26%	207	163	13	13	3.34	163	731	577
7:45-8:00	29%	227	179	29	43	10.63	179	794	627
8:00-8:15	26%	168	133	0	25	6.28	133	766	605
8:15-8:30	27%	172	136	0	11	2.71	136	774	611
8:30-8:45	23%	148	117	0	0	0.00	0	715	564
8:45-9:00	24%	155	122	0	0	0.00	0	643	507
9:00-9:15	27%	164	129	0	0	0.00	0	639	504
9:15-9:30	23%	139	110	0	0	0.00	0	606	478
9:30-9:45	26%	154	122	0	0	0.00	0	612	483
9:45-10:00	24%	147	116	0	0	0.00	0	604	477

Total Delay (veh-hr)	24
Total Vehicles Delayed (veh)	766
Average Delay (hr)	0.03
Average Delay (min)	1.89

Maximum Queue (veh)	43
Maximum Queue (ft)	638

Project: Stanford Ranch Rd/SR 65 Northbound Ramps
Ramp: Galleria Boulevard to Southbound SR 65
Scenario: Build Alternative Design Year Conditions

Configuration: 2 metered + 1 HOV
Peak Hour Volume: 1,210
Peak Period Volume: 4,670

HOV Bypass (%)	15%
Metered Volume (veh/hr)	1,031
Metering Rate (veh/hr)	1,080
Discharge Rate (veh/15 min)	270

Storage Length (ft)	640
Storage Lanes	2
Maximum Storage (veh)	43

Time Interval	Hourly Arrival Distribution	Estimated 15-Minute Volumes	Metered 15-Minute min flows	Excess Demand	Accumulated Vehicles	Total Delay (veh-hr)	Vehicles Delayed	Total Hourly Volume	Metered Hourly Volume
3:00-3:15	25%	310	264	0	0	0.00	0		
3:15-3:30	24%	305	260	0	0	0.00	0		
3:30-3:45	25%	317	270	0	0	0.03	270		
3:45-4:00	26%	330	281	11	11	2.83	281	1262	1075
4:00-4:15	25%	324	276	6	17	4.35	276	1276	1087
4:15-4:30	25%	321	274	4	21	5.23	274	1292	1101
4:30-4:45	26%	337	287	17	38	9.52	287	1312	1118
4:45-5:00	25%	321	274	4	42	10.41	274	1303	1110
5:00-5:15	27%	303	258	0	30	7.46	258	1282	1092
5:15-5:30	25%	274	233	0	0	0.00	0	1235	1052
5:30-5:45	24%	268	228	0	0	0.00	0	1166	994
5:45-3:00	24%	267	228	0	0	0.00	0	1112	948
3:00-3:15	26%	288	245	0	0	0.00	0	1097	935
3:15-3:30	26%	285	243	0	0	0.00	0	1108	944
3:30-3:45	27%	293	250	0	0	0.00	0	1133	965
3:45-4:00	20%	222	189	0	0	0.00	0	1088	927

Total Delay (veh-hr)	40
Total Vehicles Delayed (veh)	1,920
Average Delay (hr)	0.02
Average Delay (min)	1.24

Maximum Queue (veh)	42
Maximum Queue (ft)	624

SR 65 Capacity and Operational Improvements

Vissim Model Results – Existing Conditions

I-80/SR-65 Interchange
Existing Conditions

Time	VHT	VHD	Freeway	
			VHD	VMT
6 AM	4,955	815	71	222,524
7 AM	9,325	2,820	768	326,342
8 AM	9,752	2,750	487	342,530
9 AM	7,281	1,422	133	290,677
AM 4-HR	31,314	7,807	1,459	1,182,073
3 PM	12,101	4,072	1,118	388,230
4 PM	13,111	4,838	1,510	399,194
5 PM	14,507	5,760	1,740	418,208
6 PM	10,249	2,753	195	357,162
PM 4-HR	49,967	17,423	4,564	1,562,794
AM & PM	81,281	25,230	6,023	2,744,867

Freeway VHD is delay when speed is less than 35 mph on freeway links

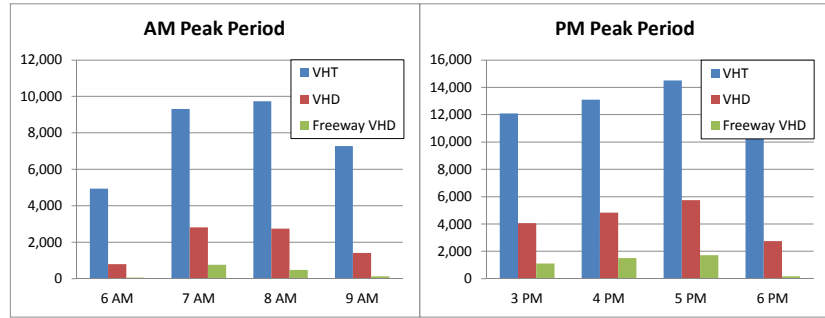

VMT by Speed Bin

Time	0-5 mph	5-10 mph	10-15 mph	15-20 mph	20-25 mph	25-30 mph	30-35 mph	35-40 mph	40-45 mph	45-50 mph	50-55 mph	55-60 mph	60-65 mph
6 AM	0	20	137	645	19,035	9,907	30,264	43,004	49,530	10,970	19,087	44,052	33,441
7 AM	898	1,734	6,784	46,117	62,160	58,011	67,869	76,657	51,912	24,558	38,864	18,977	5,002
8 AM	2,759	18,713	36,875	47,933	42,238	77,382	52,406	66,414	55,494	35,443	35,724	18,724	10,493
9 AM	1,200	3,910	15,849	28,721	39,373	44,156	46,698	63,137	46,069	15,678	61,416	37,048	14,161
AM 4-HR	4,856	24,377	59,646	123,416	162,806	189,457	197,237	249,212	203,006	86,650	155,092	118,801	63,097
3 PM	986	1,718	10,411	37,741	60,415	71,338	61,776	72,526	58,693	42,953	39,499	23,065	3,348
4 PM	923	2,580	32,375	39,279	61,525	67,866	62,203	82,481	51,583	42,338	34,833	19,799	2,422
5 PM	920	2,593	32,268	32,268	56,983	71,846	70,372	66,839	59,471	41,140	36,252	19,949	2,403
6 PM	652	258	5,883	32,596	36,277	64,218	51,007	60,898	41,940	25,173	36,280	52,444	10,076
PM 4-HR	3,480	7,149	80,936	141,884	215,201	275,268	245,359	282,745	211,688	151,605	146,864	115,257	18,248
AM & PM	8,337	31,526	140,582	265,300	378,006	464,725	442,596	531,956	414,693	238,254	301,955	234,059	81,345

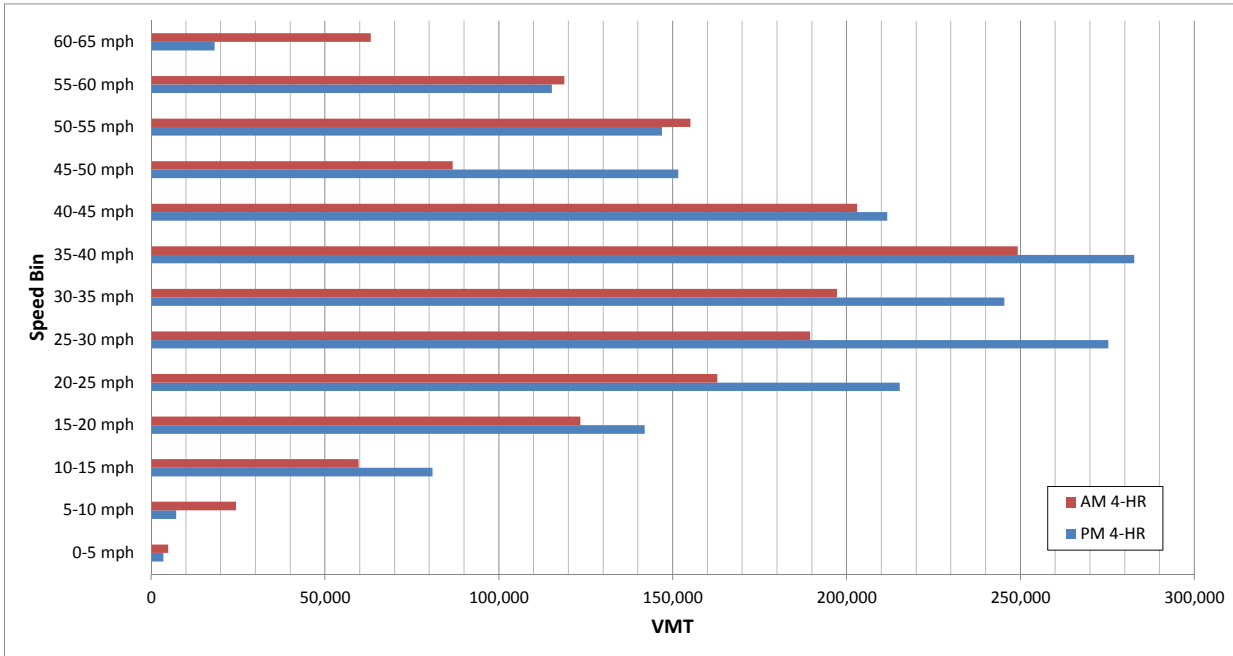

VISSIM Metrics
 Calibration Comparison
 I-80 / SR-65 Interchange
 Fehr & Peers
 Link Volumes
 February 15, 2013

AM Peak Period

Fwy	Link Location	Measured Volumes		Modeled Conditions			Link Flow Criteria		Link GEH Criteria	
		Demand Volume (vph)	Served Volume (vph)	vph	%	GEH	Measure	Meets Target?	Target	Meets Target?
	EB - Auburn Blvd Off to On-ramp	18,390	18,521	131	1%	1.0	+/- 400 vph	Yes	<5	Yes
	EB - Auburn Blvd On-ramp	2,374	2,405	31	1%	0.6	+/- 15%	Yes	<5	Yes
	EB - Auburn Blvd to Douglas Blvd	20,764	20,898	134	1%	0.9	+/- 400 vph	Yes	<5	Yes
	EB - Douglas Blvd EB Off-Ramp	4,053	4,035	-18	0%	0.3	+/- 400 vph	Yes	<5	Yes
	EB - Douglas Blvd EB to WB Off-ramp	16,711	16,832	121	1%	0.9	+/- 400 vph	Yes	<5	Yes
	EB - Douglas Blvd WB Off-Ramp	940	972	32	3%	1.0	+/- 15%	Yes	<5	Yes
	EB - Douglas Blvd Off to On-Ramp	15,771	15,848	77	0%	0.6	+/- 400 vph	Yes	<5	Yes
	EB - Douglas Blvd On-Ramp	2,981	2,951	-30	-1%	0.5	+/- 400 vph	Yes	<5	Yes
	EB - Douglas Blvd to Eureka Rd	18,752	18,783	31	0%	0.2	+/- 400 vph	Yes	<5	Yes
	EB - Eureka Rd Off-Ramp	3,572	3,754	182	5%	3.0	+/- 400 vph	Yes	<5	Yes
	EB - Eureka Rd Off to On-ramp	15,180	15,015	-166	-1%	1.3	+/- 400 vph	Yes	<5	Yes
	EB - Eureka Rd EB On-Ramp	494	516	22	4%	1.0	+/- 100 vph	Yes	<5	Yes
	EB - Eureka Rd EB to WB On-Ramp	15,674	15,526	-148	-1%	1.2	+/- 400 vph	Yes	<5	Yes
	EB - Eureka Rd WB On-Ramp	1,475	1,384	-91	-6%	2.4	+/- 15%	Yes	<5	Yes
	EB - Eureka Rd to Taylor Rd	17,149	16,903	-246	-1%	1.9	+/- 400 vph	Yes	<5	Yes
	EB - Taylor Rd Off-Ramp	744	814	70	9%	2.5	+/- 15%	Yes	<5	Yes
	EB - Taylor Rd to SR-65	16,405	16,074	-332	-2%	2.6	+/- 400 vph	Yes	<5	Yes
	EB - SR-65 Off-Ramp	8,324	7,693	-631	-8%	7.1	+/- 400 vph	No	<5	No
	EB - SR-65 Off to On-Ramp	8,081	8,365	284	4%	3.1	+/- 400 vph	Yes	<5	Yes
	EB - SR-65 On-Ramp	3,601	3,595	-6	0%	0.1	+/- 400 vph	Yes	<5	Yes
	EB - SR-65 to Rocklin Rd	11,682	11,947	265	2%	2.4	+/- 400 vph	Yes	<5	Yes
	EB - Rocklin Rd Off-Ramp	3,709	3,797	88	2%	1.4	+/- 400 vph	Yes	<5	Yes
	EB - Rocklin Rd Off to On-ramp	7,973	8,128	155	2%	1.7	+/- 400 vph	Yes	<5	Yes
	EB - Rocklin Rd On-Ramp	612	592	-20	-3%	0.8	+/- 100 vph	Yes	<5	Yes
	EB - Rocklin Rd to Sierra College Blvd	8,585	8,713	128	1%	1.4	+/- 400 vph	Yes	<5	Yes
	EB - Sierra College Rd Off-Ramp	960	988	28	3%	0.9	+/- 15%	Yes	<5	Yes
	EB - Sierra College Blvd Off to On-Ramp	7,625	7,716	91	1%	1.0	+/- 400 vph	Yes	<5	Yes
	EB - Sierra College Blvd SB On-Ramp	411	402	-9	-2%	0.5	+/- 100 vph	Yes	<5	Yes
	EB - Sierra College Blvd SB to NB On-Ramp	8,036	8,117	81	1%	0.9	+/- 400 vph	Yes	<5	Yes
	EB - Sierra College Blvd NB On-Ramp	876	835	-41	-5%	1.4	+/- 15%	Yes	<5	Yes
	EB - Sierra College Blvd to Horseshoe Bar Rd	8,912	8,947	35	0%	0.4	+/- 400 vph	Yes	<5	Yes
	WB - Horseshoe Bar Rd to Sierra College Blvd	13,864	13,940	76	1%	0.6	+/- 400 vph	Yes	<5	Yes
	WB - Sierra College Blvd Off-Ramp	2,282	2,259	-23	-1%	0.5	+/- 15%	Yes	<5	Yes
	WB - Sierra College Blvd Off to On-ramp	11,582	11,672	90	1%	0.8	+/- 400 vph	Yes	<5	Yes
	WB - Sierra College Blvd NB On-Ramp	194	196	2	1%	0.1	+/- 100 vph	Yes	<5	Yes
	WB - Sierra College Blvd NB to SB On-Ramp	11,776	11,864	88	1%	0.8	+/- 400 vph	Yes	<5	Yes
	WB - Sierra College Blvd SB On-Ramp	945	971	26	3%	0.8	+/- 15%	Yes	<5	Yes
	WB - Sierra College Blvd to Rocklin Rd	12,721	12,828	107	1%	1.0	+/- 400 vph	Yes	<5	Yes
	WB - Rocklin Rd Off-Ramp	686	686	0	0%	0.0	+/- 100 vph	Yes	<5	Yes
	WB - Rocklin Rd Off to On-Ramp	12,035	12,130	95	1%	0.9	+/- 400 vph	Yes	<5	Yes
	WB - Rocklin Rd On-Ramp	2,695	2,765	70	3%	1.3	+/- 400 vph	Yes	<5	Yes
	WB - Rocklin Rd to SR-65	14,730	14,881	151	1%	1.2	+/- 400 vph	Yes	<5	Yes
	WB - SR-65 Off-Ramp	3,865	4,072	207	5%	3.3	+/- 400 vph	Yes	<5	Yes
	WB - SR-65 Off to On-Ramp	10,865	10,789	-76	-1%	0.7	+/- 400 vph	Yes	<5	Yes
	WB - SR-65 On-Ramp	11,253	11,211	-42	0%	0.4	+/- 400 vph	Yes	<5	Yes
	WB - SR-65 to Taylor Rd	22,118	21,631	-487	-2%	3.3	+/- 400 vph	No	<5	Yes
	WB - Taylor Rd On-Ramp	1,837	1,864	27	1%	0.6	+/- 15%	Yes	<5	Yes
	WB - Taylor Rd to Atlantic St	23,955	23,855	-100	0%	0.6	+/- 400 vph	Yes	<5	Yes
	WB - Atlantic St WB Off-Ramp	1,039	1,041	2	0%	0.0	+/- 15%	Yes	<5	Yes
	WB - Atlantic St WB to EB Off-ramp	22,916	22,807	-109	0%	0.7	+/- 400 vph	Yes	<5	Yes
	WB - Atlantic St EB Off-ramp	2,814	2,719	-95	-3%	1.8	+/- 400 vph	Yes	<5	Yes
	WB - Atlantic St Off to On-ramp	20,102	20,087	-15	0%	0.1	+/- 400 vph	Yes	<5	Yes
	WB - Atlantic St On-Ramp	2,382	2,293	-89	-4%	1.8	+/- 15%	Yes	<5	Yes
	WB - Atlantic St to Douglas Blvd	22,484	22,376	-108	0%	0.7	+/- 400 vph	Yes	<5	Yes
	WB - Douglas Blvd Off-Ramp	3,203	3,058	-145	-5%	2.6	+/- 400 vph	Yes	<5	Yes
	WB - Douglas Blvd Off to On-Ramp	19,281	19,318	37	0%	0.3	+/- 400 vph	Yes	<5	Yes
	WB - Douglas Blvd WB On-Ramp	2,693	2,507	-186	-7%	3.7	+/- 15%	Yes	<5	Yes
	WB - Douglas Blvd WB to EB On-Ramp	21,974	21,825	-150	-1%	1.0	+/- 400 vph	Yes	<5	Yes
	WB - Douglas Blvd EB On-Ramp	1,255	1,257	2	0%	0.0	+/- 15%	Yes	<5	Yes
	WB - Douglas Blvd to Riverside Ave	23,229	23,071	-158	-1%	1.0	+/- 400 vph	Yes	<5	Yes
	WB - Riverside Ave Off-ramp	1,860	1,689	-171	-9%	4.1	+/- 15%	Yes	<5	Yes
	WB - Riverside Ave Off to On-Ramp	21,369	21,375	6	0%	0.0	+/- 400 vph	Yes	<5	Yes
	WB - Riverside Ave NB On-ramp	699	723	24	3%	0.9	+/- 100 vph	Yes	<5	Yes
	WB - Riverside Ave NB to SB On-Ramp	22,068	22,098	30	0%	0.2	+/- 400 vph	Yes	<5	Yes
	WB - Riverside Ave SB On-ramp	4,233	4,324	91	2%	1.4	+/- 400 vph	Yes	<5	Yes
	WB - Riverside Ave to Antelope Rd	26,301	26,420	119	0%	0.7	+/- 400 vph	Yes	<5	Yes
	WB - Antelope Rd Off-ramp	1,270	1,151	-119	-9%	3.4	+/- 15%	Yes	<5	Yes
	WB - Antelope Rd Off to On-Ramp	25,031	25,275	244	1%	1.5	+/- 400 vph	Yes	<5	Yes
	WB - Antelope Rd WB On-ramp	2,088	2,083	-5	0%	0.1	+/- 15%	Yes	<5	Yes
	WB - Antelope Rd WB to EB On-Ramp	27,119	27,359	240	1%	1.5	+/- 400 vph	Yes	<5	Yes
	WB - Antelope Rd EB On-ramp	1,448	1,441	-7	-1%	0.2	+/- 15%	Yes	<5	Yes
	WB - Antelope Rd to Elkhorn Blvd	28,567	28,633	66	0%	0.4	+/- 400 vph	Yes	<5	Yes
	WB - Elkhorn Blvd Off-ramp	2,315	2,148	-167	-7%	3.5	+/- 15%	Yes	<5	Yes
	WB - Elkhorn Blvd Off to On-Ramp	26,252	26,653	401	2%	2.5	+/- 400 vph	No	<5	Yes
	WB - Elkhorn Blvd WB On-ramp	2,597	2,587	-10	0%	0.2	+/- 15%	Yes	<5	Yes
	WB - Elkhorn Blvd WB to EB On-Ramp	28,849	29,235	386	1%	2.3	+/- 400 vph	Yes	<5	Yes
	WB - Elkhorn Blvd EB On-ramp	3,184	3,160	-24	-1%	0.4	+/- 400 vph	Yes	<5	Yes
	WB - Elkhorn Blvd to Madison Ave	32,033	32,393	360	1%	2.0	+/- 400 vph	Yes	<5	Yes
	NB - I-80 to Stanford Ranch Rd	12,189	11,737	-452	-4%	4.1	+/- 400 vph	No	<5	Yes
	NB - Stanford Ranch Rd Off-Ramp	2,331	2,239	-92	-4%	1.9	+/- 15%	Yes	<5	Yes
	NB - Stanford Ranch Rd Off to On-Ramp	9,858	9,487	-371	-4%	3.8	+/- 400 vph	Yes	<5	Yes
	NB - Stanford Ranch Rd On-Ramp	1,712	1,698	-14	-1%	0.3	+/- 15%	Yes	<5	Yes
	NB - Stanford Ranch Rd to Pleasant Grove Blvd	11,570	11,169	-401	-3%	3.8	+/- 400 vph	No	<5	Yes
	NB - Pleasant Grove Blvd Off-Ramp	2,131	1,978	-153	-7%	3.4	+/- 15%	Yes	<5	Yes
	NB - Pleasant Grove Blvd Off to On-Ramp	9,439	9,184	-255	-3%	2.6	+/- 400 vph	Yes	<5	Yes
	NB - Pleasant Grove Blvd On-Ramp	830	810	-20	-2%	0.7	+/- 15%	Yes	<5	Yes
	NB - Pleasant Grove to Blue Oaks Blvd	10,269	9,990	-279	-3%	2.8	+/- 400 vph	Yes	<5	Yes

Interstate 80

State Route 65

NB - Blue Oaks Blvd Off-Ramp	4,193	4,035	-158	-4%	2.5	+/- 400 vph	Yes	< 5	Yes
NB - Blue Oaks Blvd Off to On-Ramp	6,076	5,942	-134	-2%	1.7	+/- 400 vph	Yes	< 5	Yes
NB - Blue Oaks Blvd On-Ramp	1,134	1,118	-16	-1%	0.5	+/- 15%	Yes	< 5	Yes
NB - Blue Oaks Blvd to Sunset Blvd	7,210	7,052	-158	-2%	1.9	+/- 400 vph	Yes	< 5	Yes
NB - Sunset Blvd Off-Ramp	3,371	3,279	-92	-3%	1.6	+/- 400 vph	Yes	< 5	Yes
NB - Sunset Blvd Off to On-ramp	3,839	3,766	-73	-2%	1.2	+/- 400 vph	Yes	< 5	Yes
NB - Sunset Blvd EB On-Ramp	113	117	4	4%	0.4	+/- 100 vph	Yes	< 5	Yes
NB - Sunset Blvd EB to WB On-ramp	3,952	3,883	-70	-2%	1.1	+/- 400 vph	Yes	< 5	Yes
NB - Sunset Blvd WB On-Ramp	609	597	-12	-2%	0.5	+/- 100 vph	Yes	< 5	Yes
NB - Sunset Blvd to Twelve Bridges Dr	4,561	4,467	-94	-2%	1.4	+/- 400 vph	Yes	< 5	Yes
NB - Twelve Bridges Dr Off-Ramp	979	915	-64	-7%	2.1	+/- 15%	Yes	< 5	Yes
NB - Twelve Bridges Dr Off to On-ramp	3,582	3,542	-41	-1%	0.7	+/- 400 vph	Yes	< 5	Yes
NB - Twelve Bridges Dr On-Ramp	631	607	-24	-4%	1.0	+/- 100 vph	Yes	< 5	Yes
NB - Twelve Bridges Dr to Sterling Pkwy	4,213	4,147	-66	-2%	1.0	+/- 400 vph	Yes	< 5	Yes
SB - Sterling Pkwy to Twelve Bridges Dr	8,307	8,327	20	0%	0.2	+/- 400 vph	Yes	< 5	Yes
SB - Twelve Bridges Dr Off-Ramp	865	852	-14	-2%	0.5	+/- 15%	Yes	< 5	Yes
SB - Twelve Bridges Dr Off to On-Ramp	7,442	7,474	32	0%	0.4	+/- 400 vph	Yes	< 5	Yes
SB - Twelve Bridges Dr On-Ramp	1,930	1,876	-54	-3%	1.2	+/- 15%	Yes	< 5	Yes
SB - Twelve Bridges Dr to Sunset Blvd	9,372	9,343	-29	0%	0.3	+/- 400 vph	Yes	< 5	Yes
SB - Sunset Blvd Off-Ramp	1,081	1,041	-40	-4%	1.2	+/- 15%	Yes	< 5	Yes
SB - Sunset Blvd Off to On-ramp	8,291	8,294	3	0%	0.0	+/- 400 vph	Yes	< 5	Yes
SB - Sunset Blvd WB On-Ramp	1,224	1,203	-21	-2%	0.6	+/- 15%	Yes	< 5	Yes
SB - Sunset Blvd WB to EB On-Ramp	9,515	9,497	-18	0%	0.2	+/- 400 vph	Yes	< 5	Yes
SB - Sunset Blvd EB On-Ramp	1,075	1,040	-35	-3%	1.1	+/- 15%	Yes	< 5	Yes
SB - Sunset Blvd to Blue Oaks Blvd	10,590	10,534	-56	-1%	0.5	+/- 400 vph	Yes	< 5	Yes
SB - Blue Oaks Blvd Off-Ramp	1,761	1,798	37	2%	0.9	+/- 15%	Yes	< 5	Yes
SB - Blue Oaks Blvd Off to On-Ramp	8,829	8,729	-100	-1%	1.1	+/- 400 vph	Yes	< 5	Yes
SB - Blue Oaks Blvd WB On-Ramp	1,330	1,217	-113	-9%	3.2	+/- 15%	Yes	< 5	Yes
SB - Blue Oaks Blvd WB to EB On-Ramp	10,159	9,943	-216	-2%	2.2	+/- 400 vph	Yes	< 5	Yes
SB - Blue Oaks Blvd EB On-Ramp	3,103	2,907	-197	-6%	3.6	+/- 400 vph	Yes	< 5	Yes
SB - Blue Oaks Blvd to Pleasant Grove Blvd	13,262	12,846	-416	-3%	3.6	+/- 400 vph	No	< 5	Yes
SB - Pleasant Grove Blvd Off-Ramp	1,680	1,662	-18	-1%	0.4	+/- 15%	Yes	< 5	Yes
SB - Pleasant Grove Blvd Off to On-ramp	11,582	11,175	-407	-4%	3.8	+/- 400 vph	No	< 5	Yes
SB - Pleasant Grove Blvd WB On-Ramp	1,649	1,602	-47	-3%	1.2	+/- 15%	Yes	< 5	Yes
SB - Pleasant Grove Blvd WB to EB On-Ramp	13,231	12,776	-455	-3%	4.0	+/- 400 vph	No	< 5	Yes
SB - Pleasant Grove Blvd EB On-Ramp	1,839	1,795	-44	-2%	1.0	+/- 15%	Yes	< 5	Yes
SB - Pleasant Grove Blvd to Galleria Blvd	15,070	14,565	-506	-3%	4.2	+/- 400 vph	No	< 5	Yes
SB - Galleria Blvd Off-Ramp	2,744	2,389	-355	-13%	7.0	+/- 15%	Yes	< 5	No
SB - Galleria Blvd Off to On-Ramp	12,326	12,171	-155	-1%	1.4	+/- 400 vph	Yes	< 5	Yes
SB - Galleria Blvd On-Ramp	2,528	2,652	124	5%	2.4	+/- 15%	Yes	< 5	Yes
SB - Galleria Blvd to I-80	14,854	14,821	-33	0%	0.3	+/- 400 vph	Yes	< 5	Yes
SB SR-65 n/o Sterling Pkwy	4,945	5,436	491	10%	6.8	+/- 400 vph	No	< 5	No
NB SR-65 n/o Sterling Pkwy	3,235	3,197	-38	-1%	0.7	+/- 400 vph	Yes	< 5	Yes
EB Sterling Pkwy e/o SR-65	1,115	1,085	-30	-3%	0.9	+/- 15%	Yes	< 5	Yes
WB Sterling Pkwy e/o SR-65	3,499	3,042	-457	-13%	8.0	+/- 400 vph	No	< 5	No
EB Twelve Bridges Dr w/o SB SR-65	531	476	-55	-10%	2.5	+/- 100 vph	Yes	< 5	Yes
WB Twelve Bridges Dr w/o SB SR-65	887	830	-57	-6%	1.9	+/- 15%	Yes	< 5	Yes
EB Twelve Bridges Dr e/o SB SR-65	875	807	-68	-8%	2.3	+/- 15%	Yes	< 5	Yes
WB Twelve Bridges Dr e/o SB SR-65	2,296	2,190	-106	-5%	2.2	+/- 15%	Yes	< 5	Yes
EB Twelve Bridges Dr e/o NB SR-65	1,451	1,450	-1	0%	0.0	+/- 15%	Yes	< 5	Yes
WB Twelve Bridges Dr e/o NB SR-65	2,524	2,531	7	0%	0.1	+/- 15%	Yes	< 5	Yes
EB Sunset Blvd w/o SB SR-65	1,511	1,493	-18	-1%	0.5	+/- 15%	Yes	< 5	Yes
WB Sunset Blvd w/o SB SR-65	2,714	2,751	37	1%	0.7	+/- 400 vph	Yes	< 5	Yes
EB Sunset Blvd e/o SB SR-65	1,193	1,172	-21	-2%	0.6	+/- 15%	Yes	< 5	Yes
WB Sunset Blvd e/o SB SR-65	3,614	3,634	20	1%	0.3	+/- 400 vph	Yes	< 5	Yes
EB Sunset Blvd e/o NB SR-65	2,632	2,450	-182	-7%	3.6	+/- 15%	Yes	< 5	Yes
WB Sunset Blvd e/o NB SR-65	2,404	3,152	748	31%	14.2	+/- 400 vph	No	< 5	No
EB Blue Oaks Blvd w/o Washington Blvd	5,406	5,339	-67	-1%	0.9	+/- 400 vph	Yes	< 5	Yes
WB Blue Oaks Blvd w/o Washington Blvd	2,651	2,518	-133	-5%	2.6	+/- 15%	Yes	< 5	Yes
WB Blue Oaks Blvd w/o NB SR-65 ramp	3,617	3,139	-478	-13%	8.2	+/- 400 vph	No	< 5	No
EB Blue Oaks Blvd e/o Washington Blvd	6,018	5,583	-435	-7%	5.7	+/- 400 vph	No	< 5	No
WB Blue Oaks Blvd e/o Washington Blvd	3,264	3,140	-124	-4%	2.2	+/- 400 vph	Yes	< 5	Yes
SB Washington Blvd s/o Blue Oaks Blvd	1,884	2,159	275	15%	6.1	+/- 15%	Yes	< 5	No
NB Washington Blvd s/o Blue Oaks Blvd	1,289	1,202	-87	-7%	2.5	+/- 15%	Yes	< 5	Yes
EB Blue Oaks Blvd e/o NB SR-65	2,799	2,893	94	3%	1.8	+/- 400 vph	Yes	< 5	Yes
WB Blue Oaks Blvd e/o NB SR-65	2,973	3,024	51	2%	0.9	+/- 400 vph	Yes	< 5	Yes
EB Pleasant Grove Blvd w/o SB SR-65	4,344	4,359	15	0%	0.2	+/- 400 vph	Yes	< 5	Yes
WB Pleasant Grove Blvd w/o SB SR-65	4,792	4,816	24	0%	0.3	+/- 400 vph	Yes	< 5	Yes
EB Pleasant Grove Blvd e/o SB SR-65	2,887	2,924	37	1%	0.7	+/- 400 vph	Yes	< 5	Yes
WB Pleasant Grove Blvd e/o SB SR-65	5,143	5,121	-22	0%	0.3	+/- 400 vph	Yes	< 5	Yes
EB Pleasant Grove Blvd e/o NB SR-65	3,353	3,419	66	2%	1.1	+/- 400 vph	Yes	< 5	Yes
WB Pleasant Grove Blvd e/o NB SR-65	4,308	4,467	159	4%	2.4	+/- 400 vph	Yes	< 5	Yes
EB Five Star Blvd w/o Stanford Ranch Rd	731	643	-88	-12%	3.4	+/- 15%	Yes	< 5	Yes
WB Five Star Blvd w/o Stanford Ranch Rd	813	811	-2	0%	0.1	+/- 15%	Yes	< 5	Yes
EB Five Star Blvd e/o Stanford Ranch Rd	953	916	-37	-4%	1.2	+/- 15%	Yes	< 5	Yes
WB Five Star Blvd e/o Stanford Ranch Rd	1,207	1,173	-34	-3%	1.0	+/- 15%	Yes	< 5	Yes
SB Stanford Ranch Rd n/o Five Star Blvd	3,832	4,162	330	9%	5.2	+/- 400 vph	Yes	< 5	No
NB Stanford Ranch Rd n/o Five Star Blvd	2,174	2,033	-141	-7%	3.1	+/- 15%	Yes	< 5	Yes
SB Stanford Ranch Rd s/o Five Star Blvd	5,143	5,294	151	3%	2.1	+/- 400 vph	Yes	< 5	Yes
NB Stanford Ranch Rd s/o Five Star Blvd	3,313	3,076	-237	-7%	4.2	+/- 400 vph	Yes	< 5	Yes
SB Stanford Ranch Rd n/o NB SR-65	4,978	5,258	280	6%	3.9	+/- 400 vph	Yes	< 5	Yes
NB Stanford Ranch Rd n/o NB SR-65	3,372	3,260	-112	-3%	1.9	+/- 400 vph	Yes	< 5	Yes
SB Galleria Blvd n/o SB SR-65	5,173	5,272	99	2%	1.4	+/- 400 vph	Yes	< 5	Yes
NB Galleria Blvd n/o SB SR-65	2,948	2,746	-202	-7%	3.8	+/- 400 vph	Yes	< 5	Yes
SB Galleria Blvd s/o SB SR-65	5,320	5,196	-124	-2%	1.7	+/- 400 vph	Yes	< 5	Yes
NB Galleria Blvd s/o SB SR-65	2,879	2,939	60	2%	1.1	+/- 400 vph	Yes	< 5	Yes
EB Antelope Creek Dr w/o Galleria Blvd	167	177	10	6%	0.8	+/- 100 vph	Yes	< 5	Yes
WB Antelope Creek Dr w/o Galleria Blvd	366	366	0	0%	0.0	+/- 100 vph	Yes	< 5	Yes
EB Antelope Creek Dr e/o Galleria Blvd	593	613	20	3%	0.8	+/- 100 vph	Yes	< 5	Yes
WB Antelope Creek Dr e/o Galleria Blvd	482	524	42	9%	1.9	+/- 100 vph	Yes	< 5	Yes
SB Galleria Blvd n/o Antelope Creek Dr	4,660	4,497	-163	-4%	2.4	+/- 400 vph	Yes	< 5	Yes
NB Galleria Blvd n/o Antelope Creek Dr	2,837	2,888	51	2%	1.0	+/- 400 vph	Yes	< 5	Yes
SB Galleria Blvd s/o Antelope Creek Dr	4,292	4,162	-130	-3%	2.0	+/- 400 vph	Yes	< 5	Yes
NB Galleria Blvd s/o Antelope Creek Dr	2,779	2,804	25	1%	0.5	+/- 400 vph	Yes	< 5	Yes
EB Roseville Pkwy w/o Galleria Blvd	5,267	5,330	63	1%	0.9	+/- 400 vph	Yes	< 5	Yes
WB Roseville Pkwy w/o Galleria Blvd	3,091	3,205	114	4%	2.0	+/- 400 vph	Yes	< 5	Yes
EB Roseville Pkwy e/o Galleria Blvd	5,218	5,228	10	0%	0.1	+/- 400 vph	Yes	< 5	Yes

WB Roseville Pkwy e/o Galleria Blvd	3,859	3,908	49	1%	0.8	+/- 400 vph	Yes	<5	Yes
SB Galleria Blvd n/o Roseville Pkwy	4,339	4,192	-147	-3%	2.3	+/- 400 vph	Yes	<5	Yes
NB Galleria Blvd n/o Roseville Pkwy	2,900	2,928	28	1%	0.5	+/- 400 vph	Yes	<5	Yes
SB Galleria Blvd s/o Roseville Pkwy	3,779	3,606	-173	-5%	2.9	+/- 400 vph	Yes	<5	Yes
NB Galleria Blvd s/o Roseville Pkwy	1,523	1,537	14	1%	0.4	+/- 15%	Yes	<5	Yes
EB Roseville Pkwy w/o Creekside Ridge Dr	5,205	5,165	-40	-1%	0.6	+/- 400 vph	Yes	<5	Yes
WB Roseville Pkwy w/o Creekside Ridge Dr	3,958	4,010	52	1%	0.8	+/- 400 vph	Yes	<5	Yes
SB Creekside Ridge Dr n/o Roseville Pkwy	294	341	47	16%	2.6	+/- 100 vph	Yes	<5	Yes
NB Creekside Ridge Dr n/o Roseville Pkwy	825	700	-125	-15%	4.5	+/- 15%	No	<5	Yes
SB Creekside Ridge Dr s/o Roseville Pkwy	54	53	-1	-2%	0.1	+/- 100 vph	Yes	<5	Yes
NB Creekside Ridge Dr s/o Roseville Pkwy	43	48	5	11%	0.7	+/- 100 vph	Yes	<5	Yes
EB Roseville Pkwy w/o Taylor Rd	5,267	5,434	167	3%	2.3	+/- 400 vph	Yes	<5	Yes
WB Roseville Pkwy w/o Taylor Rd	4,562	4,690	128	3%	1.9	+/- 400 vph	Yes	<5	Yes
EB Roseville Pkwy e/o Taylor Rd	6,555	6,307	-248	-4%	3.1	+/- 400 vph	Yes	<5	Yes
WB Roseville Pkwy e/o Taylor Rd	4,804	4,616	-189	-4%	2.7	+/- 400 vph	Yes	<5	Yes
SB Taylor Rd n/o Roseville Pkwy	1,907	1,781	-127	-7%	2.9	+/- 15%	Yes	<5	Yes
NB Taylor Rd n/o Roseville Pkwy	1,193	1,203	10	1%	0.3	+/- 15%	Yes	<5	Yes
SB Taylor Rd s/o Roseville Pkwy	1,631	1,472	-159	-10%	4.0	+/- 15%	Yes	<5	Yes
NB Taylor Rd s/o Roseville Pkwy	1,963	1,842	-121	-6%	2.8	+/- 15%	Yes	<5	Yes
EB Roseville Pkwy w/o Sunrise Ave	6,452	6,251	-201	-3%	2.5	+/- 400 vph	Yes	<5	Yes
WB Roseville Pkwy w/o Sunrise Ave	4,677	4,421	-256	-5%	3.8	+/- 400 vph	Yes	<5	Yes
EB Roseville Pkwy e/o Sunrise Ave	5,098	4,917	-182	-4%	2.6	+/- 400 vph	Yes	<5	Yes
WB Roseville Pkwy e/o Sunrise Ave	4,484	4,268	-216	-5%	3.3	+/- 400 vph	Yes	<5	Yes
SB Sunrise Ave n/o Roseville Pkwy	694	585	-110	-16%	4.3	+/- 100 vph	No	<5	Yes
NB Sunrise Ave n/o Roseville Pkwy	1,700	1,624	-76	-4%	1.9	+/- 15%	Yes	<5	Yes
SB Sunrise Ave s/o Roseville Pkwy	1,790	1,552	-238	-13%	5.8	+/- 15%	Yes	<5	No
NB Sunrise Ave s/o Roseville Pkwy	1,635	1,409	-226	-14%	5.8	+/- 15%	Yes	<5	No
EB Atlantic St w/o Wills Rd	2,535	2,647	112	4%	2.2	+/- 15%	Yes	<5	Yes
WB Atlantic St w/o Wills Rd	1,895	1,882	-13	-1%	0.3	+/- 15%	Yes	<5	Yes
EB Atlantic St w/o WB I-80	2,688	2,819	131	5%	2.5	+/- 400 vph	Yes	<5	Yes
WB Atlantic St w/o WB I-80	2,057	2,055	-2	0%	0.0	+/- 15%	Yes	<5	Yes
SB Wills Rd s/o Atlantic St	1,140	1,123	-17	-2%	0.5	+/- 15%	Yes	<5	Yes
NB Wills Rd s/o Atlantic St	1,131	1,125	-6	-1%	0.2	+/- 15%	Yes	<5	Yes
SB Galleria Blvd n/o Wills Rd	3,505	3,529	24	1%	0.4	+/- 400 vph	Yes	<5	Yes
NB Galleria Blvd n/o Wills Rd	1,795	1,891	96	5%	2.2	+/- 15%	Yes	<5	Yes
SB Harding Blvd s/o Wills Rd	3,388	3,259	-129	-4%	2.2	+/- 400 vph	Yes	<5	Yes
NB Harding Blvd s/o Wills Rd	1,679	1,648	-31	-2%	0.8	+/- 15%	Yes	<5	Yes
EB Eureka Rd w/o Taylor Rd	4,725	4,721	-5	0%	0.1	+/- 400 vph	Yes	<5	Yes
WB Eureka Rd w/o Taylor Rd	2,623	3,893	1270	48%	22.3	+/- 400 vph	No	<5	No
EB Eureka Rd e/o Taylor Rd	6,002	6,106	104	2%	1.3	+/- 400 vph	Yes	<5	Yes
WB Eureka Rd e/o Taylor Rd	2,965	2,904	-61	-2%	1.1	+/- 400 vph	Yes	<5	Yes
SB Taylor Rd n/o Eureka Rd	1,495	1,223	-272	-18%	7.4	+/- 15%	No	<5	No
NB Taylor Rd n/o Eureka Rd	2,163	2,081	-82	-4%	1.8	+/- 15%	Yes	<5	Yes
EB Eureka Rd w/o Sunrise Ave	5,864	5,887	23	0%	0.3	+/- 400 vph	Yes	<5	Yes
WB Eureka Rd w/o Sunrise Ave	3,011	2,917	-94	-3%	1.7	+/- 400 vph	Yes	<5	Yes
EB Eureka Rd e/o Sunrise Ave	4,522	4,737	215	5%	3.2	+/- 400 vph	Yes	<5	Yes
WB Eureka Rd e/o Sunrise Ave	2,448	2,422	-26	-1%	0.5	+/- 15%	Yes	<5	Yes
SB Sunrise Ave n/o Eureka Rd	1,588	1,458	-130	-8%	3.3	+/- 15%	Yes	<5	Yes
NB Sunrise Ave n/o Eureka Rd	1,581	1,618	37	2%	0.9	+/- 15%	Yes	<5	Yes
SB Sunrise Ave s/o Eureka Rd	2,211	1,876	-335	-15%	7.4	+/- 15%	No	<5	No
NB Sunrise Ave s/o Eureka Rd	1,425	1,381	-44	-3%	1.2	+/- 15%	Yes	<5	Yes
EB Douglas Blvd w/o Harding Blvd	3,203	3,586	383	12%	6.6	+/- 400 vph	Yes	<5	No
WB Douglas Blvd w/o Harding Blvd	2,700	3,150	450	17%	8.3	+/- 400 vph	No	<5	No
EB Douglas Blvd e/o Harding Blvd	3,146	4,127	981	31%	16.3	+/- 400 vph	No	<5	No
WB Douglas Blvd e/o Harding Blvd	3,404	3,582	178	5%	3.0	+/- 400 vph	Yes	<5	Yes
SB Harding Blvd n/o Douglas Blvd	2,009	1,236	-774	-39%	19.2	+/- 15%	No	<5	No
NB Harding Blvd n/o Douglas Blvd	1,424	1,026	-398	-28%	11.4	+/- 15%	No	<5	No
SB Harding Blvd s/o Douglas Blvd	256	274	18	7%	1.1	+/- 100 vph	Yes	<5	Yes
NB Harding Blvd s/o Douglas Blvd	165	173	8	5%	0.6	+/- 100 vph	Yes	<5	Yes
EB Douglas Blvd w/o Sunrise Ave	6,545	6,170	-375	-6%	4.7	+/- 400 vph	Yes	<5	Yes
WB Douglas Blvd w/o Sunrise Ave	5,212	5,192	-21	0%	0.3	+/- 400 vph	Yes	<5	Yes
EB Douglas Blvd e/o Sunrise Ave	5,497	5,225	-272	-5%	3.7	+/- 400 vph	Yes	<5	Yes
WB Douglas Blvd e/o Sunrise Ave	4,698	4,796	98	2%	1.4	+/- 400 vph	Yes	<5	Yes
SB Sunrise Ave n/o Douglas Blvd	1,545	1,658	113	7%	2.8	+/- 15%	Yes	<5	Yes
NB Sunrise Ave n/o Douglas Blvd	2,298	2,324	26	1%	0.5	+/- 15%	Yes	<5	Yes
SB Sunrise Ave s/o Douglas Blvd	1,824	1,288	-536	-29%	13.6	+/- 15%	No	<5	No
NB Sunrise Ave s/o Douglas Blvd	2,043	2,254	211	10%	4.5	+/- 15%	Yes	<5	Yes
EB Woodside Dr e/o Pacific St	188	184	-4	-2%	0.3	+/- 100 vph	Yes	<5	Yes
WB Woodside Dr e/o Pacific St	469	463	-6	-1%	0.3	+/- 100 vph	Yes	<5	Yes
SB Pacific St n/o Woodside Dr	3,309	3,201	-108	-3%	1.9	+/- 400 vph	Yes	<5	Yes
NB Pacific St n/o Woodside Dr	1,605	1,634	29	2%	0.7	+/- 15%	Yes	<5	Yes
SB Pacific St s/o Woodside Dr	3,594	3,475	-119	-3%	2.0	+/- 400 vph	Yes	<5	Yes
NB Pacific St s/o Woodside Dr	1,609	1,630	21	1%	0.5	+/- 15%	Yes	<5	Yes
EB Sunset Blvd w/o Pacific St	3,711	3,624	-87	-2%	1.4	+/- 400 vph	Yes	<5	Yes
WB Sunset Blvd w/o Pacific St	1,672	1,814	142	8%	3.4	+/- 15%	Yes	<5	Yes
EB Sunset Blvd e/o Pacific St	297	281	-16	-5%	0.9	+/- 100 vph	Yes	<5	Yes
WB Sunset Blvd e/o Pacific St	463	419	-45	-10%	2.1	+/- 100 vph	Yes	<5	Yes
SB Pacific St n/o Sunset Blvd	2,096	2,239	143	7%	3.1	+/- 15%	Yes	<5	Yes
NB Pacific St n/o Sunset Blvd	2,529	2,557	28	1%	0.6	+/- 15%	Yes	<5	Yes
SB Pacific St s/o Sunset Blvd	3,311	3,216	-95	-3%	1.7	+/- 400 vph	Yes	<5	Yes
NB Pacific St s/o Sunset Blvd	1,539	1,587	48	3%	1.2	+/- 15%	Yes	<5	Yes
EB Rocklin Rd w/o Granite Dr	2,406	2,379	-27	-1%	0.5	+/- 15%	Yes	<5	Yes
WB Rocklin Rd w/o Granite Dr	1,982	1,934	-48	-2%	1.1	+/- 15%	Yes	<5	Yes
EB Rocklin Rd e/o Granite Dr	3,000	3,008	8	0%	0.2	+/- 400 vph	Yes	<5	Yes
WB Rocklin Rd e/o Granite Dr	3,009	2,922	-87	-3%	1.6	+/- 400 vph	Yes	<5	Yes
SB Granite Dr n/o Rocklin Rd	1,160	1,165	5	0%	0.1	+/- 15%	Yes	<5	Yes
NB Granite Dr n/o Rocklin Rd	1,673	1,596	-77	-5%	1.9	+/- 15%	Yes	<5	Yes
EB Rocklin Rd w/o WB I-80	3,153	3,195	42	1%	0.8	+/- 400 vph	Yes	<5	Yes
WB Rocklin Rd w/o WB I-80	3,161	3,103	-58	-2%	1.0	+/- 400 vph	Yes	<5	Yes
EB Rocklin Rd e/o WB I-80	1,981	2,005	24	1%	0.5	+/- 15%	Yes	<5	Yes
WB Rocklin Rd e/o WB I-80	3,998	3,994	-4	0%	0.1	+/- 400 vph	Yes	<5	Yes
EB Rocklin Rd e/o EB I-80	3,572	3,596	24	1%	0.4	+/- 400 vph	Yes	<5	Yes
WB Rocklin Rd e/o EB I-80	2,492	2,395	-97	-4%	2.0	+/- 15%	Yes	<5	Yes
EB Rocklin Rd w/o Aguilar Rd	3,581	3,561	-20	-1%	0.3	+/- 400 vph	Yes	<5	Yes
WB Rocklin Rd w/o Aguilar Rd	2,567	2,249	-319	-12%	6.5	+/- 15%	Yes	<5	No
EB Rocklin Rd e/o Aguilar Rd	3,295	3,248	-47	-1%	0.8	+/- 400 vph	Yes	<5	Yes
WB Rocklin Rd e/o Aguilar Rd	2,029	1,985	-44	-2%	1.0	+/- 15%	Yes	<5	Yes

SB Aguilar Rd s/o Rocklin Rd	152	173	21	14%	1.6	+/- 100 vph	Yes	< 5	Yes
NB Aguilar Rd s/o Rocklin Rd	404	343	-61	-15%	3.2	+/- 100 vph	Yes	< 5	Yes
Overall	1,450,418	1,442,063	-8355	-0.6%	6.9	+/- 5%	Yes	< 4	No

Link Volumes		
	Target	% Met
< 700 vph	> 85 %	95%
> 700 & < 2,700 vph	> 85 %	96%
> 2,700 vph	> 85 %	90%
GEH Statistic	> 85 %	90%

Aggregated Volumes		
	Target	% Met
Intersections	> 85 %	86%
Interchanges	> 85 %	100%

VISSIM Metrics
 Calibration Comparison
 I-80/SR 65 Interchange
 Fehr & Peers
 Travel Time
 June 3, 2012

AM Peak Period

Path	Time Period	Measured	Modeled Conditions			Calibration Targets ¹	
		Travel Time (minutes)	Travel Time (minutes)	Difference (minutes)	Percent Difference	Target	Meets Target?
I-80 WB: Blue Oaks Blvd to Antelope Road	7:15 - 7:30	10.27	8.40	-1.87	-18.2%	+/- 15%	No
	7:45 - 8:00	10.80	10.38	-0.42	-3.9%	+/- 15%	Yes
	8:15 - 8:30	8.05	8.50	0.45	5.6%	+/- 15%	Yes
I-80 EB: Antelope Road to Blue Oaks Blvd	7:00 - 7:15	6.69	6.79	0.10	1.5%	+/- 15%	Yes
	7:45 - 8:00	7.28	7.46	0.18	2.5%	+/- 15%	Yes
	8:15 - 8:30	6.99	6.89	-0.10	-1.5%	+/- 15%	Yes
	8:45 - 9:00	6.93	6.89	-0.04	-0.6%	+/- 15%	Yes
I-80 WB: Sierra College Blvd to Antelope Road	7:00 - 7:15	7.98	9.34	1.36	17.0%	+/- 15%	No
	7:30 - 7:45	8.25	8.46	0.21	2.5%	+/- 15%	Yes
	8:00 - 8:15	7.83	8.48	0.64	8.2%	+/- 15%	Yes
	8:30 - 8:45	7.73	8.33	0.60	7.7%	+/- 15%	Yes
I-80 EB: Antelope Road to Sierra College Blvd	7:15 - 7:30	5.93	6.58	0.65	10.9%	+/- 15%	Yes
	7:45 - 8:00	6.13	6.71	0.58	9.5%	+/- 15%	Yes
	8:30 - 8:45	5.91	6.55	0.64	10.9%	+/- 15%	Yes
	8:45 - 9:00	6.16	6.55	0.39	6.4%	+/- 15%	Yes

Measure	% Cases
> 85%	87%
Met Target	

VISSIM Post-Processor
Average Values from 10 Runs
Network Statistics

I-80/SR 65 Interchange
Existing Conditions
AM Peak Period

Network Performance	Vehicle Types	Average	Std. Dev.
Number of Vehicles Served	All Vehicles	143,451	56
Travel Distance [mi]	All Vehicles	645,274	1,372
Travel Time [h]	All Vehicles	13,757	107.7
Average Speed [mph]	All Vehicles	46.9	0.4
Total Delay [h]	All Vehicles	2,672	118.7
Average Delay per Vehicle [s]	All Vehicles	66	2.9
VHD/VMT [min/mile]	All Vehicles	0.25	0.01
Number of Vehicles Served	HOV	29,190	103
Travel Distance [mi]	HOV	127,289	610
Travel Time [h]	HOV	2,707	23
Average Speed [mph]	HOV	47.0	0.3
Total Delay [h]	HOV	518	19
Average Delay per Vehicle [s]	HOV	63	2
VHD/VMT [min/mile]	HOV	0.24	0.01
Number of Vehicles Served	Truck	3,675	31
Travel Distance [mi]	Truck	19,339	309
Travel Time [h]	Truck	398	6
Average Speed [mph]	Truck	48.5	0
Total Delay [h]	Truck	68	3
Average Delay per Vehicle [s]	Truck	65	3
VHD/VMT [min/mile]	Truck	0.21	0.01

Performance Measure	Vehicle Types		
	HOV	Truck	All
Vehicles Served	29,190	3,670	143,450
Demand Volume	24,518	3,839	143,735
Percent Demand Served	119.1%	95.6%	99.8%
Vehicle Miles of Travel	127,290	19,340	645,270
Person Miles of Travel	267,310	20,310	786,260
Vehicle Hours of Travel	2,710	400	13,760
Vehicle Hours of Delay	520	70	2,670
VHD % of VHT	19.2%	17.5%	19.4%
Average Delay per Vehicle (min)	1.07	1.14	1.12
Person Hours of Delay	1,090	70	3,240
Average Travel Speed	47.0	48.5	46.9

VISSIM Post-Processor
Average Results from 10 Runs
Freeway Operations Summary

I-80 / SR-65 Interchange
Existing Conditions
AM Peak Hour

Location		Facility Type	Mainline Volume (vph)			On-ramp Volume (vph)			Off-ramp Volume (vph)			Speed (mph)		Density (vplpm)		LOS
			Avg.	St. Dev.	%	Avg.	St. Dev.	%	Avg.	St. Dev.	%	Avg.	St. Dev.	Avg.	St. Dev.	
1	I-80 EB - Auburn Blvd On-ramp	Merge	6,073	57	112.3%	845	15	115.0%				59.1	1.3	24.5	0.6	C
2	I-80 EB - Auburn Blvd to Douglas Blvd	Basic	6,906	71	112.4%							62.2	0.2	27.9	0.3	D
3	I-80 EB - Douglas Blvd EB Off-ramp	Diverge	6,902	66	112.3%				1,398	64	109.9%	62.1	0.7	23.8	0.6	C
4	I-80 EB - Douglas Blvd WB Off-ramp	Diverge	5,505	78	113.0%				337	36	115.0%	63.4	0.3	18.7	0.4	B
5	I-80 EB - Douglas Blvd Off to On-ramp	Basic	5,162	72	112.7%							63.6	0.1	21.2	0.3	C
6	I-80 EB - Douglas Blvd On-ramp	Merge	5,161	74	112.7%	857	34	100.2%				61.3	1.1	26.8	0.9	C
7	I-80 EB - Eureka Rd Off-ramp	Diverge	6,016	101	110.7%				1,219	72	111.4%	61.7	0.4	26.2	0.5	C
8	I-80 EB - Eureka Rd Off to On-ramp	Basic	4,795	109	110.4%							63.3	0.2	21.0	0.3	C
9	I-80 EB - Eureka Rd EB On-ramp	Merge	4,798	116	110.5%	200	25	123.6%				63.3	0.2	18.6	0.3	B
10	I-80 EB - Eureka Rd to Taylor Rd	Weave	5,001	127	111.0%	438	40	102.9%	242	32	115.3%	62.4	0.4	23.0	0.6	C
11	I-80 EB - Taylor Rd to SR-65	Basic	5,201	117	110.2%							62.0	0.3	26.5	0.6	D
17	I-80 EB - SR-65 Off-ramp	Diverge	5,204	112	110.3%				2,534	83	106.6%	61.5	0.6	27.6	0.4	C
18	I-80 EB - SR-65 Off to On-ramp	Basic	2,671	96	113.9%							64.0	0.1	14.1	0.5	B
19	I-80 EB - SR-65 On-ramp	Merge	2,674	100	114.1%	1,275	72	111.5%				61.3	1.4	20.9	0.7	C
20	I-80 EB - SR-65 to Lane Drop	Basic	3,953	126	113.3%							60.4	2.1	24.9	1.0	C
21	I-80 EB - Lane Drop to Rocklin Rd	Basic	3,955	123	113.4%							62.2	0.6	24.6	0.8	C
22	I-80 EB - Rocklin Rd Off-ramp	Diverge	3,957	124	113.4%				1,284	72	113.6%	61.1	1.0	22.2	0.9	C
23	I-80 EB - Rocklin Rd Off to On-ramp	Basic	2,674	106	113.4%							63.5	0.5	16.9	0.8	B
24	I-80 EB - Rocklin Rd On-ramp	Merge	2,674	105	113.4%	220	26	119.1%				62.5	0.5	15.7	0.5	B
25	I-80 EB - Rocklin Rd to Sierra College Blvd	Basic	2,895	101	113.9%							63.9	0.1	17.2	0.7	B

Notes: Average density reported for the analysis area only: for example, within the ramp influence area and not including the HOV lane.
Mainline volume is the upstream served volume for all lanes.

VISSIM Post-Processor
Average Results from 10 Runs
Freeway Operations Summary

I-80 / SR-65 Interchange
Existing Conditions
AM Peak Hour

Location	Facility	Mainline Volume (vph)			On-ramp Volume (vph)			Off-ramp Volume (vph)			Speed (mph)		Density (vplpm)		LOS	
	Type	Avg.	St. Dev.	%	Avg.	St. Dev.	%	Avg.	St. Dev.	%	Avg.	St. Dev.	Avg.	St. Dev.		
26	I-80 EB - Sierra College Blvd Off-ramp	Diverge	2,898	100	113.9%				296	27	110.0%	63.3	0.5	17.9	0.7	B
27	I-80 EB - Sierra College Blvd Off to On-ramp	Basic	2,606	89	114.6%							63.7	0.3	16.5	0.5	B
28	I-80 EB - Sierra College Blvd SB On-ramp	Merge	2,608	89	114.7%	133	4	102.5%				63.0	0.3	15.1	0.4	B
29	I-80 EB - Sierra College Blvd NB On-ramp	Merge	2,742	91	114.1%	277	8	107.6%				60.8	0.7	16.6	0.4	B
38	I-80 WB - Sierra College Blvd Off-ramp	Diverge	4,202	25	105.7%				733	39	107.7%	59.2	1.0	22.2	0.5	C
39	I-80 WB - Sierra College Blvd Off to On-ramp	Basic	3,466	49	105.2%							63.0	0.4	20.9	0.2	C
40	I-80 WB - Sierra College Blvd NB On-ramp	Merge	3,464	53	105.2%	55	3	103.4%				63.2	0.2	18.1	0.2	B
41	I-80 WB - Sierra College Blvd SB On-ramp	Merge	3,517	57	105.1%	292	6	109.8%				60.1	1.0	19.5	0.4	B
42	I-80 WB - Sierra College Blvd to Rocklin Rd	Basic	3,804	66	105.3%							63.4	0.1	21.2	0.3	C
43	I-80 WB - Rocklin Rd Off-ramp	Diverge	3,802	65	105.2%				240	29	111.9%	63.1	0.2	21.2	0.5	C
44	I-80 WB - Rocklin Rd Off to On-ramp	Basic	3,560	60	104.7%							63.3	0.1	19.8	0.2	C
45	I-80 WB - Rocklin Rd On-ramp	Merge	3,559	65	104.7%	763	40	104.5%				53.4	2.0	24.4	1.5	C
46	I-80 WB - Rocklin Rd to HOV Lane Start	Basic	4,313	86	104.5%							61.3	0.3	26.3	0.5	D
47	I-80 WB - HOV Lane Start to SR-65	Basic	4,312	92	104.4%							63.1	0.2	17.8	0.3	B
48	I-80 WB - SR-65 Off-ramp	Diverge	4,311	95	104.4%				1,173	52	102.2%	63.1	0.5	17.8	0.6	B
49	I-80 WB - SR-65 Off to On-ramp	Basic	3,131	85	105.0%							63.2	0.3	17.7	0.5	B
50	I-80 WB - SR-65 On-ramp	Merge	3,262	104	109.4%	2,916	80	103.0%				63.0	0.1	24.7	0.3	C

Notes: Average density reported for the analysis area only: for example, within the ramp influence area and not including the HOV lane.

Mainline volume is the upstream served volume for all lanes.

VISSIM Post-Processor
Average Results from 10 Runs
Freeway Operations Summary

I-80 / SR-65 Interchange
Existing Conditions
AM Peak Hour

	Location	Facility Type	Mainline Volume (vph)			On-ramp Volume (vph)			Off-ramp Volume (vph)			Speed (mph)		Density (vplpm)		LOS
			Avg.	St. Dev.	%	Avg.	St. Dev.	%	Avg.	St. Dev.	%	Avg.	St. Dev.	Avg.	St. Dev.	
60	I-80 WB - Taylor Rd On-ramp	Merge	6,040	128	103.9%	584	43	113.5%				62.1	0.2	27.7	0.4	C
61	I-80 WB - Atlantic St WB Off-ramp	Diverge	6,623	144	104.7%				347	38	112.4%	64.4	0.3	17.7	0.6	B
62	I-80 WB - Atlantic St EB Off-ramp	Diverge	6,274	141	104.3%				828	63	100.2%	52.9	3.1	37.3	2.1	E
63	I-80 WB - Atlantic St Off to On-ramp	Basic	5,434	150	104.7%							62.6	0.4	22.4	0.6	C
64	I-80 WB - Atlantic St On-ramp	Merge	5,431	137	104.6%	684	43	104.6%				59.1	2.1	24.2	0.9	C
65	I-80 WB - Douglas Blvd Off-ramp	Diverge	6,114	144	104.6%				879	55	99.7%	56.5	3.0	18.7	0.9	B
66	I-80 WB - Douglas Rd Off to On-ramp	Basic	5,239	146	105.5%							60.8	1.5	29.9	0.9	D
67	I-80 WB - Douglas Blvd WB On-ramp	Merge	5,239	139	105.5%	797	52	103.9%				52.0	3.4	35.6	2.7	E
68	I-80 WB - Douglas Blvd EB On-ramp	Merge	6,037	132	105.3%	406	39	106.8%				48.4	3.1	41.7	3.3	E
69	I-80 WB - Douglas Blvd to Riverside Ave	Basic	6,433	134	105.3%							62.5	0.3	33.1	0.7	D
70	I-80 WB - Riverside Ave Off-ramp	Diverge	6,428	134	105.2%				473	43	89.5%	54.1	5.4	40.3	4.6	E
71	I-80 WB - Riverside Ave Off to On-ramp	Basic	5,958	134	106.7%							60.8	0.9	31.4	0.9	D
72	I-80 WB - Riverside Ave NB On-ramp	Merge	5,960	132	106.8%	122	7	61.2%				63.2	0.1	19.9	0.9	B
73	I-80 WB - Riverside Ave SB On-ramp	Merge	6,083	133	105.2%	1,185	15	105.6%				62.8	0.7	23.3	0.9	C
74	I-80 WB - Riverside Ave to Antelope Rd	Basic	7,270	137	105.3%							63.0	0.1	27.8	0.6	D
75	I-80 WB - Antelope Rd Off-ramp	Diverge	7,272	142	105.3%				288	40	87.2%	60.1	7.7	27.7	7.3	C

Notes: Average density reported for the analysis area only: for example, within the ramp influence area and not including the HOV lane.
Mainline volume is the upstream served volume for all lanes.

VISSIM Post-Processor
Average Results from 10 Runs
Freeway Operations Summary

I-80 / SR 65 Interchange
Existing Conditions
AM Peak Hour

	Location	Facility	Mainline Volume (vph)			On-ramp Volume (vph)			Off-ramp Volume (vph)			Speed (mph)		Density (vplpm)		LOS
		Type	Avg.	St. Dev.	%	Avg.	St. Dev.	%	Avg.	St. Dev.	%	Avg.	St. Dev.	Avg.	St. Dev.	
76	I-80 WB - Antelope Rd Off to On-ramp	Basic	6,981	122	106.2%							53.4	15.1	37.6	24.7	E
77	I-80 WB - Antelope Rd WB On-ramp	Merge	6,985	156	106.2%	546	26	103.7%				41.1	15.3	53.5	31.7	F
78	I-80 WB - Antelope Rd to Truck Scales	Weave	7,558	233	106.4%	334	10	89.8%	38	15		38.3	18.8	61.8	30.7	F
79	I-80 WB - Truck Scales Off to On-ramp	Basic	7,995	416	107.0%							30.2	14.6	89.2	31.0	F
80	I-80 WB - Truck Scales On-ramp	Merge	8,989	517	120.3%	38	15					23.5	1.2	106.3	4.3	F
81	I-80 WB - Truck Scales to Elkhorn Blvd	Basic	8,159	475	109.2%							24.1	1.8	104.6	8.6	F
82	I-80 WB - Elkhorn Blvd Off-ramp	Diverge	8,175	473	109.4%				647	54	98.7%	27.1	2.3	79.8	4.9	F
83	I-80 WB - Elkhorn Blvd Off to On-ramp	Basic	7,567	424	111.0%							56.6	0.7	29.9	1.3	D
84	I-80 WB - Elkhorn Blvd WB On-ramp	Merge	7,570	427	111.0%	635	43	100.6%				52.4	2.4	35.0	3.7	E
85	I-80 WB - Elkhorn Blvd EB On-ramp	Merge	8,195	410	110.0%	810	23	100.1%				56.6	6.2	35.0	5.9	E

Notes: Average density reported for the analysis area only: for example, within the ramp influence area and not including the HOV lane.
Mainline volume is the upstream served volume for all lanes.

VISSIM Post-Processor
Average Results from 10 Runs
Freeway Operations Summary

I-80 / SR-65 Interchange
Existing Conditions
AM Peak Hour

	Location	Facility Type	Mainline Volume (vph)			On-ramp Volume (vph)			Off-ramp Volume (vph)			Speed (mph)		Density (vplpm)		LOS
			Avg.	St. Dev.	%	Avg.	St. Dev.	%	Avg.	St. Dev.	%	Avg.	St. Dev.	Avg.	St. Dev.	
97	SR-65 SB - Twelve Bridges Dr Off-ramp	Diverge	2,633	65	109.0%				305	32	111.7%	63.4	0.3	19.0	0.5	B
98	SR-65 SB - Twelve Bridges Dr Off to On-ramp	Basic	2,326	63	108.6%							63.2	0.2	19.3	0.6	C
99	SR-65 SB - Twelve Bridges Dr On-ramp	Merge	2,323	65	108.5%	612	31	114.6%				49.7	1.7	26.0	1.3	C
100	SR-65 SB - Twelve Bridges Dr to Sunset Blvd	Basic	2,931	74	109.5%							62.6	0.1	25.0	0.5	C
101	SR-65 SB - Sunset Blvd Off-ramp	Diverge	2,927	68	109.4%				366	37	104.5%	62.7	0.2	23.2	0.4	C
102	SR-65 SB - Sunset Blvd Off to On-ramp	Basic	2,560	80	110.0%							62.7	0.2	22.0	0.7	C
103	SR-65 SB - Sunset Blvd WB On-ramp	Merge	2,557	84	109.9%	414	33	109.9%				56.3	2.7	25.2	1.6	C
104	SR-65 SB - Sunset Blvd EB On-ramp	Merge	2,973	96	110.0%	314	23	104.5%				59.8	6.4	29.5	8.4	D
105	SR-65 SB - Sunset Blvd to Blue Oaks Blvd	Basic	3,281	88	109.3%							62.0	0.3	27.7	0.9	D
106	SR-65 SB - Blue Oaks Blvd Off-ramp	Diverge	3,278	88	109.1%				633	36	117.5%	57.3	3.5	29.2	1.8	D
107	SR-65 SB - Blue Oaks Blvd Off to On-ramp	Basic	2,640	74	107.1%							48.5	13.7	31.9	11.3	D
108	SR-65 SB - Blue Oaks Blvd WB On-ramp	Merge	2,636	80	107.0%	371	32	95.8%				28.3	14.0	60.2	24.7	F
109	SR-65 SB - Blue Oaks Blvd to Pleasant Grove Blvd	Weave	3,008	96	105.5%	844	55	96.9%	635	57	105.5%	20.0	3.2	74.9	8.6	F
110	SR-65 SB - Pleasant Grove Blvd Off to On-ramp	Basic	3,198	86	102.5%							19.4	0.7	88.7	1.8	F
111	SR-65 SB - Pleasant Grove Blvd WB On-ramp	Merge	3,190	71	102.2%	453	34	106.5%				20.8	2.1	72.4	6.0	F
112	SR-65 SB - Pleasant Grove Blvd EB On-ramp	Merge	3,637	63	102.6%	546	35	102.5%				36.5	0.5	53.4	1.2	F
113	SR-65 SB - Pleasant Grove Blvd to Galleria Blvd	Basic	4,176	50	102.4%							60.0	1.7	35.6	1.1	E
114	SR-65 SB - Galleria Blvd Off-ramp	Diverge	4,176	50	102.4%				763	44	95.3%	60.6	1.1	35.2	0.5	E
115	SR-65 SB - Galleria Blvd Off to Lane Add	Basic	3,411	66	104.0%							61.6	1.9	30.3	1.3	D
116	SR-65 SB - Lane Add to Galleria Blvd On-ramp	Basic	3,414	67	104.1%							63.3	0.2	21.0	0.5	C
117	SR-65 SB - Galleria Blvd On-ramp	Merge	3,414	69	104.1%	777	45	111.6%				51.4	3.3	30.1	2.9	D
118	SR-65 SB - I-80 WB Off-ramp	Diverge	4,190	81	105.4%				2,918	82	103.1%	62.7	0.4	23.8	0.5	C

Notes: Average density reported for the analysis area only: for example, within the ramp influence area and not including the HOV lane.
Mainline volume is the upstream served volume for all lanes.

VISSIM Post-Processor
Average Results from 10 Runs
Freeway Operations Summary

I-80 / SR-65 Interchange
Existing Conditions
AM Peak Hour

Location		Facility	Mainline Volume (vph)			On-ramp Volume (vph)			Off-ramp Volume (vph)			Speed (mph)		Density (vp/ln)		LOS
		Type	Avg.	St. Dev.	%	Avg.	St. Dev.	%	Avg.	St. Dev.	%	Avg.	St. Dev.	Avg.	St. Dev.	
125	SR-65 NB - I-80 WB On-ramp	Merge	2,531	94	107.1%	1,173	61	65.3%				35.6	5.2	52.9	10.5	F
126	SR-65 NB - I-80 to Stanford Ranch Rd	Basic	3,704	109	89.0%							60.4	1.6	32.2	1.1	D
127	SR-65 NB - Stanford Ranch Rd Off-ramp	Diverge	3,704	107	105.1%				633	49	101.3%	59.8	1.6	32.9	1.0	D
128	SR-65 NB - Stanford Ranch Rd Off to On-ramp	Basic	3,072	115	106.0%							62.5	0.5	26.9	1.1	D
129	SR-65 NB - Stanford Ranch Rd On-ramp	Merge	3,074	110	106.1%	561	45	106.4%				53.2	4.5	33.6	3.4	D
130	SR-65 NB - Stanford Ranch Rd to Pleasant Grove Blvd	Basic	3,632	112	106.0%							61.1	0.7	30.1	1.1	D
131	SR-65 NB - Pleasant Grove Blvd Off-ramp	Diverge	3,632	112	106.0%				611	36	100.5%	62.0	0.5	28.1	1.1	D
132	SR-65 NB - Pleasant Grove Blvd Off to On-ramp	Basic	3,018	114	107.1%							62.7	0.5	26.6	1.0	D
133	SR-65 NB - Pleasant Grove Blvd to Blue Oaks Blvd	Weave	3,021	118	107.2%	206	22	95.0%	1,430	82	104.6%	63.3	0.1	21.1	1.1	C
134	SR-65 NB - Blue Oaks Blvd Off to On-ramp	Basic	1,799	83	107.9%							63.7	0.2	16.0	0.7	B
135	SR-65 NB - Blue Oaks Blvd On-ramp	Merge	1,799	86	108.0%	319	31	99.5%				60.9	1.1	17.4	0.6	B
136	SR-65 NB - Blue Oaks Blvd to Sunset Blvd	Basic	2,115	78	106.5%							63.3	0.2	18.4	0.7	C
137	SR-65 NB - Sunset Blvd Off-ramp	Diverge	2,116	84	106.5%				1,003	50	102.4%	63.5	0.1	16.4	0.6	B
138	SR-65 NB - Sunset Blvd Off to On-ramp	Basic	1,115	58	110.6%							64.1	0.1	10.4	0.6	A
139	SR-65 NB - Sunset Blvd EB On-ramp	Merge	1,117	60	110.8%	38	14	113.9%				63.5	0.4	10.6	0.5	B
140	SR-65 NB - Sunset Blvd WB On-ramp	Merge	1,154	63	110.8%	216	27	114.2%				64.3	0.2	10.3	0.6	B
141	SR-65 NB - Sunset Blvd to Twelve Bridges Dr	Basic	1,374	71	111.7%							63.8	0.2	12.7	0.5	B
142	SR-65 NB - Twelve Bridges Dr Off-ramp	Diverge	1,377	70	112.1%				275	33	96.0%	63.6	0.1	12.8	0.5	B
143	SR-65 NB - Twelve Bridges Dr Off to On-ramp	Basic	1,106	58	117.3%							63.9	0.2	10.7	0.4	A
144	SR-65 NB - Twelve Bridges Dr On-ramp	Merge	1,109	59	117.6%	219	18	108.4%				62.7	0.4	11.7	0.3	B

Notes: Average density reported for the analysis area only: for example, within the ramp influence area and not including the HOV lane.
Mainline volume is the upstream served volume for all lanes.

VISSIM Post-Processor
Average Results from 10 Runs
Intersection Volume and Delay

I-80 / SR-65 Interchange
Existing Conditions
AM Peak Hour

	Intersection	Control	Volume (vph)		Percent Served	Delay (sec/veh)		Level of Service
			Demand	Served		Average	Std. Dev.	
1	SR-65/Sterling Pkwy	Signal	3,592	4,018	111.9%	18.7	0.8	B
2	SR-65 SB Ramps/Twelve Bridges Dr	Signal	1,086	1,200	110.5%	3.8	0.2	A
3	SR-65 NB Ramps/Twelve Bridges Dr	Signal	1,305	1,426	109.3%	3.3	0.4	A
4	SR-65 SB Ramps/Sunset Blvd	Signal	1,789	1,961	109.6%	7.0	0.5	A
5	SR-65 NB Ramps/Sunset Blvd	Signal	2,101	2,227	106.0%	9.9	0.4	A
6	SR-65 SB Ramps-Washington Blvd/Blue Oaks	Signal	3,555	3,653	102.8%	43.4	12.9	D
7	SR-65 NB Ramps/Blue Oaks Blvd	Signal	2,229	2,308	103.5%	23.7	8.3	C
8	SR-65 SB Ramps/Pleasant Grove Blvd	Signal	3,383	3,542	104.7%	9.1	1.1	A
9	SR-65 NB Ramps/Pleasant Grove Blvd	Signal	2,720	2,864	105.3%	10.3	0.9	B
10	Stanford Ranch Rd/Five Star Blvd	Signal	2,578	2,842	110.2%	18.8	1.1	B
11	SR-65 NB Ramps/Stanford Ranch Rd	Signal	2,941	3,201	108.9%	8.5	1.3	A
12	SR-65 SB Ramps/Galleria Blvd	Signal	3,107	3,308	106.5%	12.8	0.8	B
13	Galleria Blvd/Antelope Creek Dr	Signal	2,373	2,551	107.5%	10.3	1.0	B
14	Galleria Blvd/Roseville Pkwy	Signal	4,665	5,153	110.5%	29.8	1.9	C
15	Creekside Ridge Dr/Roseville Pkwy	Signal	3,147	3,527	112.1%	5.7	0.6	A
16	Taylor Rd/East Roseville Pkwy	Signal	4,274	4,645	108.7%	29.5	3.7	C
17	North Sunrise Ave/East Roseville Pkwy	Signal	4,073	4,218	103.6%	37.2	4.4	D
18	Wills Rd/Atlantic St	Signal	1,717	1,953	113.7%	10.2	0.6	B
19	I-80 WB Ramps/Atlantic St	Signal	2,676	2,885	107.8%	7.0	0.6	A
20	Taylor Rd-I-80 EB Ramps/Eureka Rd	Signal	3,496	4,005	114.6%	26.4	3.1	C
21	North Sunrise Ave/Eureka Rd	Signal	3,296	3,463	105.1%	24.1	4.8	C
22	Harding Blvd/Wills Rd	Signal	1,952	2,133	109.3%	11.6	0.8	B
23	Harding Blvd/Douglas Blvd	Signal	2,603	2,782	106.9%	18.5	1.2	B
24	I-80 WB Ramps/Douglas Blvd	Signal	3,426	3,597	105.0%	14.4	1.4	B

Network Summary	
Total Demand Volume (veh/hr)	68,084
Total Volume Served (veh/hr)	73,464
Percent Served	107.9%

- Notes: 1. Volume is measured for the entire peak hour.
2. Delay is measured for the peak 15 minutes in the peak hour.
3. For Side-street Stop and Uncontrolled intersections, the delay for the highest movement is reported.

VISSIM Post-Processor
Average Results from 10 Runs
Intersection Volume and Delay

I-80 / SR-65 Interchange
Existing Conditions
AM Peak Hour

Intersection	Control	Volume (vph)		Percent Served	Delay (sec/veh)		Level of Service	
		Demand	Served		Average	Std. Dev.		
25	I-80 EB Ramps/Douglas Blvd	Signal	3,868	4,094	105.9%	5.5	0.5	A
26	North Sunrise Ave/Douglas Blvd	Signal	4,048	4,364	107.8%	26.3	1.1	C
27	Pacific St/Woodside Dr	Signal	1,576	1,703	108.1%	6.6	0.4	A
28	Pacific St/Sunset Blvd	Signal	2,323	2,619	112.8%	17.7	1.5	B
29	Granite Dr/Rocklin Rd	Signal	1,985	2,085	105.0%	14.7	1.5	B
30	I-80 WB Ramps/Rocklin Rd	Signal	2,326	2,514	108.1%	21.3	2.4	C
31	I-80 EB Ramps/Rocklin Rd	Signal	2,448	2,739	111.9%	17.1	1.1	B
32	Aguilar Rd/Rocklin Rd	Signal	1,783	1,979	111.0%	8.0	1.2	A
253	Galleria Blvd/Berry St	Signal	1,805	1,944	107.7%	8.5	0.9	A

Network Summary	
Total Demand Volume (veh/hr)	22,162
Total Volume Served (veh/hr)	24,042
Percent Served	108.5%

Notes: 1. Volume is measured for the entire peak hour.
2. Delay is measured for the peak 15 minutes in the peak hour.

VISSIM Metrics
 Calibration Comparison
 I-80 / SR 65 Interchange
 Fehr & Peers
 Link Volumes
 February 15, 2013

PM Peak Period

Fwy	Link Location	Measured Volumes		Modeled Conditions			Link Flow Criteria		Link GEH Criteria	
		Demand Volume (vph)	Served Volume (vph)	Difference			Measure	Meets Target?	Target	Meets Target?
				vph	%	GEH				
	EB - Auburn Blvd Off to On-ramp	24,273	24,417	144	0.6%	0.9	+/- 400 vph	Yes	< 5	Yes
	EB - Auburn Blvd On-ramp	2,625	2,461	-164	-6.3%	3.3	+/- 15%	Yes	< 5	Yes
	EB - Auburn Blvd to Douglas Blvd	26,898	26,889	-9	0.0%	0.1	+/- 400 vph	Yes	< 5	Yes
	EB - Douglas Blvd EB Off-Ramp	4,450	4,467	17	0.4%	0.3	+/- 400 vph	Yes	< 5	Yes
	EB - Douglas Blvd EB to WB Off-ramp	22,448	22,430	-18	-0.1%	0.1	+/- 400 vph	Yes	< 5	Yes
	EB - Douglas Blvd WB Off-Ramp	1,519	1,594	75	4.9%	1.9	+/- 15%	Yes	< 5	Yes
	EB - Douglas Blvd Off to On-Ramp	20,929	20,839	-90	-0.4%	0.6	+/- 400 vph	Yes	< 5	Yes
	EB - Douglas Blvd On-Ramp	4,441	4,388	-53	-1.2%	0.8	+/- 400 vph	Yes	< 5	Yes
	EB - Douglas Blvd to Eureka Rd	25,370	25,232	-138	-0.5%	0.9	+/- 400 vph	Yes	< 5	Yes
	EB - Eureka Rd Off-Ramp	3,787	3,701	-86	-2.3%	1.4	+/- 400 vph	Yes	< 5	Yes
	EB - Eureka Rd Off to On-ramp	21,583	21,534	-49	-0.2%	0.3	+/- 400 vph	Yes	< 5	Yes
	EB - Eureka Rd EB On-Ramp	825	919	94	11.4%	3.2	+/- 15%	Yes	< 5	Yes
	EB - Eureka Rd EB to WB On-Ramp	22,408	22,451	43	0.2%	0.3	+/- 400 vph	Yes	< 5	Yes
	EB - Eureka Rd WB On-Ramp	3,287	3,406	119	3.6%	2.1	+/- 400 vph	Yes	< 5	Yes
	EB - Eureka Rd to Taylor Rd	25,695	25,862	167	0.7%	1.0	+/- 400 vph	Yes	< 5	Yes
	EB - Taylor Rd Off-Ramp	1,809	1,861	52	2.9%	1.2	+/- 15%	Yes	< 5	Yes
	EB - Taylor Rd to SR-65	23,886	24,009	123	0.5%	0.8	+/- 400 vph	Yes	< 5	Yes
	EB - SR-65 Off-Ramp	12,666	12,443	-223	-1.8%	2.0	+/- 400 vph	Yes	< 5	Yes
	EB - SR-65 Off to On-Ramp	11,220	11,581	361	3.2%	3.4	+/- 400 vph	Yes	< 5	Yes
	EB - SR-65 On-Ramp	5,807	5,848	41	0.7%	0.5	+/- 400 vph	Yes	< 5	Yes
	EB - SR-65 to Rocklin Rd	17,027	17,439	412	2.4%	3.1	+/- 400 vph	No	< 5	Yes
	EB - Rocklin Rd Off-Ramp	4,352	4,615	263	6.0%	3.9	+/- 400 vph	Yes	< 5	Yes
	EB - Rocklin Rd Off to On-ramp	12,675	12,852	177	1.4%	1.6	+/- 400 vph	Yes	< 5	Yes
	EB - Rocklin Rd On-Ramp	947	932	-15	-1.6%	0.5	+/- 15%	Yes	< 5	Yes
	EB - Rocklin Rd to Sierra College Blvd	13,622	13,795	173	1.3%	1.5	+/- 400 vph	Yes	< 5	Yes
	EB - Sierra College Rd Off-Ramp	1,069	1,233	164	15.3%	4.8	+/- 15%	No	< 5	Yes
	EB - Sierra College Blvd Off to On-Ramp	12,553	12,565	12	0.1%	0.1	+/- 400 vph	Yes	< 5	Yes
	EB - Sierra College Blvd SB On-Ramp	757	742	-15	-2.0%	0.6	+/- 15%	Yes	< 5	Yes
	EB - Sierra College Blvd SB to NB On-Ramp	13,310	13,310	0	0.0%	0.0	+/- 400 vph	Yes	< 5	Yes
	EB - Sierra College Blvd NB On-Ramp	1,613	1,608	-5	-0.3%	0.1	+/- 15%	Yes	< 5	Yes
	EB - Sierra College Blvd to Horseshoe Bar Rd	14,923	14,924	1	0.0%	0.0	+/- 400 vph	Yes	< 5	Yes
	WB - Horseshoe Bar Rd to Sierra College Blvd	11,488	11,488	0	0.0%	0.0	+/- 400 vph	Yes	< 5	Yes
	WB - Sierra College Blvd Off-ramp	1,748	1,727	-21	-1.2%	0.5	+/- 15%	Yes	< 5	Yes
	WB - Sierra College Blvd Off to On-ramp	9,740	9,766	26	0.3%	0.3	+/- 400 vph	Yes	< 5	Yes
	WB - Sierra College Blvd NB On-Ramp	336	328	-8	-2.4%	0.4	+/- 100 vph	Yes	< 5	Yes
	WB - Sierra College Blvd NB to SB On-Ramp	10,076	10,096	20	0.2%	0.2	+/- 400 vph	Yes	< 5	Yes
	WB - Sierra College Blvd SB On-Ramp	859	922	63	7.3%	2.1	+/- 15%	Yes	< 5	Yes
	WB - Sierra College Blvd to Rocklin Rd	10,935	11,029	94	0.9%	0.9	+/- 400 vph	Yes	< 5	Yes
	WB - Rocklin Rd Off-Ramp	926	889	-37	-4.0%	1.2	+/- 15%	Yes	< 5	Yes
	WB - Rocklin Rd Off to On-Ramp	10,009	10,151	142	1.4%	1.4	+/- 400 vph	Yes	< 5	Yes
	WB - Rocklin Rd On-Ramp	3,742	3,849	107	2.9%	1.7	+/- 400 vph	Yes	< 5	Yes
	WB - Rocklin Rd to SR-65	13,751	14,019	268	1.9%	2.3	+/- 400 vph	Yes	< 5	Yes
	WB - SR-65 Off-Ramp	4,649	4,810	161	3.5%	2.3	+/- 400 vph	Yes	< 5	Yes
	WB - SR-65 Off to On-Ramp	9,102	9,230	128	1.4%	1.3	+/- 400 vph	Yes	< 5	Yes
	WB - SR-65 On-Ramp	9,425	9,356	-69	-0.7%	0.7	+/- 400 vph	Yes	< 5	Yes
	WB - SR-65 to Taylor Rd	18,527	18,255	-272	-1.5%	2.0	+/- 400 vph	Yes	< 5	Yes
	WB - Taylor Rd On-Ramp	1,604	1,595	-9	-0.6%	0.2	+/- 15%	Yes	< 5	Yes
	WB - Taylor Rd to Atlantic St	20,131	20,192	61	0.3%	0.4	+/- 400 vph	Yes	< 5	Yes
	WB - Atlantic St WB Off-Ramp	1,282	1,378	96	7.5%	2.6	+/- 15%	Yes	< 5	Yes
	WB - Atlantic St WB to EB Off-ramp	18,849	18,827	-22	-0.1%	0.2	+/- 400 vph	Yes	< 5	Yes
	WB - Atlantic St EB Off-ramp	2,525	2,576	51	2.0%	1.0	+/- 15%	Yes	< 5	Yes
	WB - Atlantic St Off to On-ramp	16,324	16,264	-60	-0.4%	0.5	+/- 400 vph	Yes	< 5	Yes
	WB - Atlantic St On-Ramp	3,356	3,540	184	5.5%	3.1	+/- 400 vph	Yes	< 5	Yes
	WB - Atlantic St to Douglas Blvd	19,680	19,814	134	0.7%	1.0	+/- 400 vph	Yes	< 5	Yes
	WB - Douglas Blvd Off-Ramp	3,440	3,435	-5	-0.1%	0.1	+/- 400 vph	Yes	< 5	Yes
	WB - Douglas Blvd Off to On-Ramp	16,240	16,385	145	0.9%	1.1	+/- 400 vph	Yes	< 5	Yes
	WB - Douglas Blvd WB On-Ramp	4,066	3,783	-283	-7.0%	4.5	+/- 400 vph	Yes	< 5	Yes
	WB - Douglas Blvd WB to EB On-Ramp	20,306	20,170	-136	-0.7%	1.0	+/- 400 vph	Yes	< 5	Yes
	WB - Douglas Blvd EB On-Ramp	1,618	1,614	-4	-0.3%	0.1	+/- 15%	Yes	< 5	Yes
	WB - Douglas Blvd to Riverside Ave	21,924	21,811	-113	-0.5%	0.8	+/- 400 vph	Yes	< 5	Yes
	WB - Riverside Ave Off-ramp	2,708	2,608	-100	-3.7%	1.9	+/- 400 vph	Yes	< 5	Yes
	WB - Riverside Ave Off to On-Ramp	19,216	19,227	11	0.1%	0.1	+/- 400 vph	Yes	< 5	Yes
	WB - Riverside Ave NB On-ramp	701	703	2	0.2%	0.1	+/- 15%	Yes	< 5	Yes
	WB - Riverside Ave NB to SB On-Ramp	19,917	19,932	15	0.1%	0.1	+/- 400 vph	Yes	< 5	Yes
	WB - Riverside Ave SB On-ramp	3,138	3,368	230	7.3%	4.0	+/- 400 vph	Yes	< 5	Yes
	WB - Riverside Ave to Antelope Rd	23,055	23,322	267	1.2%	1.8	+/- 400 vph	Yes	< 5	Yes
	WB - Antelope Rd Off-ramp	3,357	3,370	13	0.4%	0.2	+/- 400 vph	Yes	< 5	Yes
	WB - Antelope Rd Off to On-Ramp	19,698	19,978	280	1.4%	2.0	+/- 400 vph	Yes	< 5	Yes
	WB - Antelope Rd WB On-ramp	1,313	1,307	-6	-0.5%	0.2	+/- 15%	Yes	< 5	Yes
	WB - Antelope Rd WB to EB On-Ramp	21,011	21,289	278	1.3%	1.9	+/- 400 vph	Yes	< 5	Yes
	WB - Antelope Rd EB On-ramp	936	925	-11	-1.1%	0.3	+/- 15%	Yes	< 5	Yes
	WB - Antelope Rd to Elkhorn Blvd	21,947	22,156	209	1.0%	1.4	+/- 400 vph	Yes	< 5	Yes
	WB - Elkhorn Blvd Off-ramp	3,750	3,755	5	0.1%	0.1	+/- 400 vph	Yes	< 5	Yes
	WB - Elkhorn Blvd Off to On-Ramp	18,197	18,515	318	1.7%	2.3	+/- 400 vph	Yes	< 5	Yes
	WB - Elkhorn Blvd WB On-ramp	2,529	2,530	1	0.0%	0.0	+/- 15%	Yes	< 5	Yes
	WB - Elkhorn Blvd WB to EB On-Ramp	20,726	21,048	322	1.6%	2.2	+/- 400 vph	Yes	< 5	Yes
	WB - Elkhorn Blvd EB On-Ramp	2,294	2,286	-8	-0.3%	0.2	+/- 15%	Yes	< 5	Yes
	WB - Elkhorn Blvd to Madison Ave	23,020	23,341	321	1.4%	2.1	+/- 400 vph	Yes	< 5	Yes
	NB - I-80 to Stanford Ranch Rd	17,315	17,273	-42	-0.2%	0.3	+/- 400 vph	Yes	< 5	Yes
	NB - Stanford Ranch Rd Off-Ramp	4,687	4,834	147	3.1%	2.1	+/- 400 vph	Yes	< 5	Yes
	NB - Stanford Ranch Rd Off to On-Ramp	12,628	12,446	-182	-1.4%	1.6	+/- 400 vph	Yes	< 5	Yes
	NB - Stanford Ranch Rd On-Ramp	3,634	3,483	-151	-4.2%	2.5	+/- 400 vph	Yes	< 5	Yes
	NB - Stanford Ranch Rd to Pleasant Grove Blvd	16,262	15,935	-327	-2.0%	2.6	+/- 400 vph	Yes	< 5	Yes
	NB - Pleasant Grove Blvd Off-Ramp	4,030	4,181	151	3.7%	2.4	+/- 400 vph	Yes	< 5	Yes
	NB - Pleasant Grove Blvd Off to On-Ramp	12,232	11,759	-473	-3.9%	4.3	+/- 400 vph	No	< 5	Yes
	NB - Pleasant Grove Blvd On-Ramp	2,089	2,020	-69	-3.3%	1.5	+/- 15%	Yes	< 5	Yes
	NB - Pleasant Grove to Blue Oaks Blvd	14,321	13,782	-539	-3.8%	4.5	+/- 400 vph	No	< 5	Yes

Interstate 80

NB - Blue Oaks Blvd Off-Ramp	4,701	4,204	-497	-10.6%	7.5	+/- 400 vph	No	< 5	No
NB - Blue Oaks Blvd Off to On-Ramp	9,620	9,588	-32	-0.3%	0.3	+/- 400 vph	Yes	< 5	Yes
NB - Blue Oaks Blvd On-Ramp	1,793	1,861	68	3.8%	1.6	+/- 15%	Yes	< 5	Yes
NB - Blue Oaks Blvd to Sunset Blvd	11,413	11,454	41	0.4%	0.4	+/- 400 vph	Yes	< 5	Yes
NB - Sunset Blvd Off-Ramp	2,780	2,705	-75	-2.7%	1.4	+/- 400 vph	Yes	< 5	Yes
NB - Sunset Blvd Off to On-ramp	8,633	8,754	121	1.4%	1.3	+/- 400 vph	Yes	< 5	Yes
NB - Sunset Blvd EB On-Ramp	247	249	2	0.9%	0.1	+/- 100 vph	Yes	< 5	Yes
NB - Sunset Blvd EB to WB On-ramp	8,880	9,003	123	1.4%	1.3	+/- 400 vph	Yes	< 5	Yes
NB - Sunset Blvd WB On-Ramp	1,002	955	-47	-4.7%	1.5	+/- 15%	Yes	< 5	Yes
NB - Sunset Blvd to Twelve Bridges Dr	9,882	9,958	76	0.8%	0.8	+/- 400 vph	Yes	< 5	Yes
NB - Twelve Bridges Dr Off-Ramp	2,235	2,165	-70	-3.1%	1.5	+/- 15%	Yes	< 5	Yes
NB - Twelve Bridges Dr Off to On-ramp	7,647	7,799	152	2.0%	1.7	+/- 400 vph	Yes	< 5	Yes
NB - Twelve Bridges Dr On-Ramp	1,100	916	-184	-16.7%	5.8	+/- 15%	No	< 5	No
NB - Twelve Bridges Dr to Sterling Pkwy	8,747	8,715	-32	-0.4%	0.3	+/- 400 vph	Yes	< 5	Yes
SB - Sterling Pkwy to Twelve Bridges Dr	6,566	6,641	75	1.1%	0.9	+/- 400 vph	Yes	< 5	Yes
SB - Twelve Bridges Dr Off-Ramp	855	840	-15	-1.8%	0.5	+/- 15%	Yes	< 5	Yes
SB - Twelve Bridges Dr Off to On-Ramp	5,711	5,807	96	1.7%	1.3	+/- 400 vph	Yes	< 5	Yes
SB - Twelve Bridges Dr On-Ramp	1,519	1,587	68	4.5%	1.7	+/- 15%	Yes	< 5	Yes
SB - Twelve Bridges Dr to Sunset Blvd	7,230	7,417	187	2.6%	2.2	+/- 400 vph	Yes	< 5	Yes
SB - Sunset Blvd Off-Ramp	912	982	70	7.7%	2.3	+/- 15%	Yes	< 5	Yes
SB - Sunset Blvd Off to On-ramp	6,318	6,459	141	2.2%	1.8	+/- 400 vph	Yes	< 5	Yes
SB - Sunset Blvd WB On-Ramp	1,782	1,774	-8	-0.5%	0.2	+/- 15%	Yes	< 5	Yes
SB - Sunset Blvd WB to EB On-Ramp	8,100	8,238	138	1.7%	1.5	+/- 400 vph	Yes	< 5	Yes
SB - Sunset Blvd EB On-Ramp	2,299	2,230	-69	-3.0%	1.5	+/- 15%	Yes	< 5	Yes
SB - Sunset Blvd to Blue Oaks Blvd	10,399	10,485	86	0.8%	0.8	+/- 400 vph	Yes	< 5	Yes
SB - Blue Oaks Blvd Off-Ramp	1,997	2,024	27	1.4%	0.6	+/- 15%	Yes	< 5	Yes
SB - Blue Oaks Blvd Off to On-Ramp	8,402	8,477	75	0.9%	0.8	+/- 400 vph	Yes	< 5	Yes
SB - Blue Oaks Blvd WB On-Ramp	1,415	1,067	-348	-24.6%	9.9	+/- 15%	No	< 5	No
SB - Blue Oaks Blvd WB to EB On-Ramp	9,817	9,547	-270	-2.7%	2.7	+/- 400 vph	Yes	< 5	Yes
SB - Blue Oaks Blvd EB On-Ramp	3,384	3,205	-179	-5.3%	3.1	+/- 400 vph	Yes	< 5	Yes
SB - Blue Oaks Blvd to Pleasant Grove Blvd	13,201	12,756	-445	-3.4%	3.9	+/- 400 vph	No	< 5	Yes
SB - Pleasant Grove Blvd Off-Ramp	2,177	2,256	79	3.6%	1.7	+/- 15%	Yes	< 5	Yes
SB - Pleasant Grove Blvd Off to On-ramp	11,024	10,512	-512	-4.6%	4.9	+/- 400 vph	No	< 5	Yes
SB - Pleasant Grove Blvd WB On-Ramp	1,252	1,403	151	12.1%	4.1	+/- 15%	Yes	< 5	Yes
SB - Pleasant Grove Blvd WB to EB On-Ramp	12,276	11,917	-359	-2.9%	3.3	+/- 400 vph	Yes	< 5	Yes
SB - Pleasant Grove Blvd EB On-Ramp	2,281	2,298	17	0.8%	0.4	+/- 15%	Yes	< 5	Yes
SB - Pleasant Grove Blvd to Galleria Blvd	14,557	14,227	-330	-2.3%	2.7	+/- 400 vph	Yes	< 5	Yes
SB - Galleria Blvd Off-Ramp	3,198	2,954	-244	-7.6%	4.4	+/- 400 vph	Yes	< 5	Yes
SB - Galleria Blvd Off to On-Ramp	11,359	11,277	-82	-0.7%	0.8	+/- 400 vph	Yes	< 5	Yes
SB - Galleria Blvd On-Ramp	3,873	3,913	40	1.0%	0.6	+/- 400 vph	Yes	< 5	Yes
SB - Galleria Blvd to I-80	15,232	15,191	-42	-0.3%	0.3	+/- 400 vph	Yes	< 5	Yes
SB SR 65 n/o Sterling Pkwy	4,588	4,645	57	1.2%	0.8	+/- 400 vph	Yes	< 5	Yes
NB SR 65 n/o Sterling Pkwy	5,719	5,876	157	2.7%	2.1	+/- 400 vph	Yes	< 5	Yes
EB Sterling Pkwy e/o SR 65	3,251	3,078	-173	-5.3%	3.1	+/- 400 vph	Yes	< 5	Yes
WB Sterling Pkwy e/o SR 65	2,201	2,212	11	0.5%	0.2	+/- 15%	Yes	< 5	Yes
EB Twelve Bridges Dr w/o SB SR 65	1,293	1,066	-227	-17.5%	6.6	+/- 15%	No	< 5	No
WB Twelve Bridges Dr w/o SB SR 65	980	972	-8	-0.8%	0.2	+/- 15%	Yes	< 5	Yes
EB Twelve Bridges Dr e/o SB SR 65	1,588	1,358	-230	-14.5%	6.0	+/- 15%	Yes	< 5	No
WB Twelve Bridges Dr e/o SB SR 65	1,939	2,007	68	3.5%	1.5	+/- 15%	Yes	< 5	Yes
EB Twelve Bridges Dr e/o NB SR 65	2,866	2,870	4	0.1%	0.1	+/- 400 vph	Yes	< 5	Yes
WB Twelve Bridges Dr e/o NB SR 65	2,082	2,260	178	8.5%	3.8	+/- 15%	Yes	< 5	Yes
EB Sunset Blvd w/o SB SR 65	3,297	3,262	-36	-1.1%	0.6	+/- 400 vph	Yes	< 5	Yes
WB Sunset Blvd w/o SB SR 65	2,178	1,974	-204	-9.4%	4.5	+/- 15%	Yes	< 5	Yes
EB Sunset Blvd e/o SB SR 65	1,729	1,843	114	6.6%	2.7	+/- 15%	Yes	< 5	Yes
WB Sunset Blvd e/o SB SR 65	3,779	3,574	-205	-5.4%	3.4	+/- 400 vph	Yes	< 5	Yes
EB Sunset Blvd e/o NB SR 65	2,794	3,011	217	7.8%	4.0	+/- 400 vph	Yes	< 5	Yes
WB Sunset Blvd e/o NB SR 65	3,313	3,699	386	11.6%	6.5	+/- 400 vph	Yes	< 5	No
EB Blue Oaks Blvd w/o Washington Blvd	6,884	6,938	54	0.8%	0.6	+/- 400 vph	Yes	< 5	Yes
WB Blue Oaks Blvd w/o Washington Blvd	4,031	4,363	332	8.2%	5.1	+/- 400 vph	Yes	< 5	No
WB Blue Oaks Blvd w/o NB SR 65 ramp	4,121	3,935	-186	-4.5%	2.9	+/- 400 vph	Yes	< 5	Yes
EB Blue Oaks Blvd e/o Washington Blvd	7,841	8,142	301	3.8%	3.4	+/- 400 vph	Yes	< 5	Yes
WB Blue Oaks Blvd e/o Washington Blvd	4,121	3,935	-186	-4.5%	2.9	+/- 400 vph	Yes	< 5	Yes
SB Washington Blvd s/o Blue Oaks Blvd	2,016	2,226	210	10.4%	4.6	+/- 15%	Yes	< 5	Yes
NB Washington Blvd s/o Blue Oaks Blvd	2,631	2,893	262	9.9%	5.0	+/- 15%	Yes	< 5	Yes
EB Blue Oaks Blvd e/o NB SR 65	5,033	4,856	-177	-3.5%	2.5	+/- 400 vph	Yes	< 5	Yes
WB Blue Oaks Blvd e/o NB SR 65	4,208	4,167	-41	-1.0%	0.6	+/- 400 vph	Yes	< 5	Yes
EB Pleasant Grove Blvd w/o SB SR 65	8,489	8,443	-46	-0.5%	0.5	+/- 400 vph	Yes	< 5	Yes
WB Pleasant Grove Blvd w/o SB SR 65	7,805	7,617	-188	-2.4%	2.1	+/- 400 vph	Yes	< 5	Yes
EB Pleasant Grove Blvd e/o SB SR 65	6,863	6,824	-39	-0.6%	0.5	+/- 400 vph	Yes	< 5	Yes
WB Pleasant Grove Blvd e/o SB SR 65	7,535	7,439	-96	-1.3%	1.1	+/- 400 vph	Yes	< 5	Yes
EB Pleasant Grove Blvd e/o NB SR 65	7,475	8,013	538	7.2%	6.1	+/- 400 vph	No	< 5	No
WB Pleasant Grove Blvd e/o NB SR 65	6,206	6,460	254	4.1%	3.2	+/- 400 vph	Yes	< 5	Yes
EB Five Star Blvd w/o Stanford Ranch Rd	2,109	1,952	-157	-7.5%	3.5	+/- 15%	Yes	< 5	Yes
WB Five Star Blvd w/o Stanford Ranch Rd	2,278	2,440	162	7.1%	3.3	+/- 15%	Yes	< 5	Yes
EB Five Star Blvd e/o Stanford Ranch Rd	2,045	1,973	-72	-3.5%	1.6	+/- 15%	Yes	< 5	Yes
WB Five Star Blvd e/o Stanford Ranch Rd	2,149	2,048	-101	-4.7%	2.2	+/- 15%	Yes	< 5	Yes
SB Stanford Ranch Rd n/o Five Star Blvd	4,046	4,073	27	0.7%	0.4	+/- 400 vph	Yes	< 5	Yes
NB Stanford Ranch Rd n/o Five Star Blvd	5,446	5,674	228	4.2%	3.1	+/- 400 vph	Yes	< 5	Yes
SB Stanford Ranch Rd s/o Five Star Blvd	6,916	6,422	-494	-7.1%	6.0	+/- 400 vph	No	< 5	No
NB Stanford Ranch Rd s/o Five Star Blvd	8,381	8,436	55	0.7%	0.6	+/- 400 vph	Yes	< 5	Yes
SB Stanford Ranch Rd n/o NB SR 65	7,033	7,188	155	2.2%	1.8	+/- 400 vph	Yes	< 5	Yes
NB Stanford Ranch Rd n/o NB SR 65	8,645	8,930	285	3.3%	3.0	+/- 400 vph	Yes	< 5	Yes
SB Galleria Blvd n/o SB SR 65	7,496	7,542	46	0.6%	0.5	+/- 400 vph	Yes	< 5	Yes
NB Galleria Blvd n/o SB SR 65	8,055	7,920	-135	-1.7%	1.5	+/- 400 vph	Yes	< 5	Yes
SB Galleria Blvd s/o SB SR 65	7,601	7,650	49	0.6%	0.6	+/- 400 vph	Yes	< 5	Yes
NB Galleria Blvd s/o SB SR 65	8,835	8,978	143	1.6%	1.5	+/- 400 vph	Yes	< 5	Yes
EB Antelope Creek Dr w/o Galleria Blvd	2,174	1,568	-606	-27.9%	14.0	+/- 15%	No	< 5	No
WB Antelope Creek Dr w/o Galleria Blvd	1,268	1,268	0	0.0%	0.0	+/- 15%	Yes	< 5	Yes
EB Antelope Creek Dr e/o Galleria Blvd	1,729	1,711	-18	-1.0%	0.4	+/- 15%	Yes	< 5	Yes
WB Antelope Creek Dr e/o Galleria Blvd	2,233	2,264	31	1.4%	0.6	+/- 15%	Yes	< 5	Yes
SB Galleria Blvd n/o Antelope Creek Dr	5,692	5,706	14	0.2%	0.2	+/- 400 vph	Yes	< 5	Yes
NB Galleria Blvd n/o Antelope Creek Dr	8,167	8,262	95	1.2%	1.0	+/- 400 vph	Yes	< 5	Yes
SB Galleria Blvd s/o Antelope Creek Dr	5,838	5,547	-291	-5.0%	3.9	+/- 400 vph	Yes	< 5	Yes
NB Galleria Blvd s/o Antelope Creek Dr	6,903	7,010	107	1.5%	1.3	+/- 400 vph	Yes	< 5	Yes
EB Roseville Pkwy w/o Galleria Blvd	7,361	7,396	35	0.5%	0.4	+/- 400 vph	Yes	< 5	Yes
WB Roseville Pkwy w/o Galleria Blvd	7,438	7,603	165	2.2%	1.9	+/- 400 vph	Yes	< 5	Yes
EB Roseville Pkwy e/o Galleria Blvd	6,337	6,253	-84	-1.3%	1.1	+/- 400 vph	Yes	< 5	Yes

WB Roseville Pkwy e/o Galleria Blvd	7,876	7,764	-112	-1.4%	1.3	+/- 400 vph	Yes	< 5	Yes
SB Galleria Blvd n/o Roseville Pkwy	5,990	5,795	-195	-3.3%	2.5	+/- 400 vph	Yes	< 5	Yes
NB Galleria Blvd n/o Roseville Pkwy	6,770	6,928	158	2.3%	1.9	+/- 400 vph	Yes	< 5	Yes
SB Galleria Blvd s/o Roseville Pkwy	4,986	4,833	-153	-3.1%	2.2	+/- 400 vph	Yes	< 5	Yes
NB Galleria Blvd s/o Roseville Pkwy	4,304	4,663	359	8.3%	5.4	+/- 400 vph	Yes	< 5	No
EB Roseville Pkwy w/o Creekside Ridge Dr	6,104	5,974	-130	-2.1%	1.7	+/- 400 vph	Yes	< 5	Yes
WB Roseville Pkwy w/o Creekside Ridge Dr	8,191	8,079	-112	-1.4%	1.2	+/- 400 vph	Yes	< 5	Yes
SB Creekside Ridge Dr n/o Roseville Pkwy	1,277	1,196	-81	-6.3%	2.3	+/- 15%	Yes	< 5	Yes
NB Creekside Ridge Dr n/o Roseville Pkwy	1,114	1,049	-65	-5.8%	2.0	+/- 15%	Yes	< 5	Yes
SB Creekside Ridge Dr s/o Roseville Pkwy	200	107	-93	-46.6%	7.5	+/- 100 vph	Yes	< 5	No
NB Creekside Ridge Dr s/o Roseville Pkwy	219	180	-39	-17.8%	2.8	+/- 100 vph	Yes	< 5	Yes
EB Roseville Pkwy w/o Taylor Rd	6,880	6,964	84	1.2%	1.0	+/- 400 vph	Yes	< 5	Yes
WB Roseville Pkwy w/o Taylor Rd	8,785	8,885	100	1.1%	1.1	+/- 400 vph	Yes	< 5	Yes
EB Roseville Pkwy e/o Taylor Rd	7,238	7,048	-190	-2.6%	2.3	+/- 400 vph	Yes	< 5	Yes
WB Roseville Pkwy e/o Taylor Rd	9,251	8,800	-451	-4.9%	4.8	+/- 400 vph	No	< 5	Yes
SB Taylor Rd n/o Roseville Pkwy	2,071	2,153	82	3.9%	1.8	+/- 15%	Yes	< 5	Yes
NB Taylor Rd n/o Roseville Pkwy	3,106	2,834	-272	-8.8%	5.0	+/- 400 vph	Yes	< 5	Yes
SB Taylor Rd s/o Roseville Pkwy	2,246	2,166	-80	-3.6%	1.7	+/- 15%	Yes	< 5	Yes
NB Taylor Rd s/o Roseville Pkwy	3,173	3,017	-156	-4.9%	2.8	+/- 400 vph	Yes	< 5	Yes
EB Roseville Pkwy w/o Sunrise Ave	7,106	7,018	-88	-1.2%	1.0	+/- 400 vph	Yes	< 5	Yes
WB Roseville Pkwy w/o Sunrise Ave	9,053	8,465	-589	-6.5%	6.3	+/- 400 vph	No	< 5	No
EB Roseville Pkwy e/o Sunrise Ave	6,566	6,647	81	1.2%	1.0	+/- 400 vph	Yes	< 5	Yes
WB Roseville Pkwy e/o Sunrise Ave	7,019	6,617	-402	-5.7%	4.9	+/- 400 vph	No	< 5	Yes
SB Sunrise Ave n/o Roseville Pkwy	1,633	1,612	-21	-1.3%	0.5	+/- 15%	Yes	< 5	Yes
NB Sunrise Ave n/o Roseville Pkwy	840	842	2	0.3%	0.1	+/- 15%	Yes	< 5	Yes
SB Sunrise Ave s/o Roseville Pkwy	2,297	2,087	-210	-9.1%	4.5	+/- 15%	Yes	< 5	Yes
NB Sunrise Ave s/o Roseville Pkwy	2,998	2,794	-205	-6.8%	3.8	+/- 400 vph	Yes	< 5	Yes
EB Atlantic St w/o Wills Rd	2,932	2,955	23	0.8%	0.4	+/- 400 vph	Yes	< 5	Yes
WB Atlantic St w/o Wills Rd	3,655	3,753	98	2.7%	1.6	+/- 400 vph	Yes	< 5	Yes
EB Atlantic St w/o WB I-80	2,999	3,242	243	8.1%	4.3	+/- 400 vph	Yes	< 5	Yes
WB Atlantic St w/o WB I-80	3,376	3,704	328	9.7%	5.5	+/- 400 vph	Yes	< 5	No
SB Wills Rd s/o Atlantic St	1,580	1,554	-26	-1.6%	0.6	+/- 15%	Yes	< 5	Yes
NB Wills Rd s/o Atlantic St	1,926	1,884	-42	-2.2%	1.0	+/- 15%	Yes	< 5	Yes
SB Galleria Blvd n/o Wills Rd	4,110	4,126	16	0.4%	0.2	+/- 400 vph	Yes	< 5	Yes
NB Galleria Blvd n/o Wills Rd	4,521	4,695	174	3.8%	2.6	+/- 400 vph	Yes	< 5	Yes
SB Harding Blvd s/o Wills Rd	3,793	3,654	-139	-3.7%	2.3	+/- 400 vph	Yes	< 5	Yes
NB Harding Blvd s/o Wills Rd	4,541	4,580	39	0.9%	0.6	+/- 400 vph	Yes	< 5	Yes
EB Eureka Rd w/o Taylor Rd	4,744	4,898	154	3.2%	2.2	+/- 400 vph	Yes	< 5	Yes
WB Eureka Rd w/o Taylor Rd	7,602	8,335	733	9.6%	8.2	+/- 400 vph	No	< 5	No
EB Eureka Rd e/o Taylor Rd	5,485	5,641	156	2.8%	2.1	+/- 400 vph	Yes	< 5	Yes
WB Eureka Rd e/o Taylor Rd	6,615	7,145	530	8.0%	6.4	+/- 400 vph	No	< 5	No
SB Taylor Rd n/o Eureka Rd	2,455	2,320	-135	-5.5%	2.8	+/- 15%	Yes	< 5	Yes
NB Taylor Rd n/o Eureka Rd	3,334	3,171	-163	-4.9%	2.9	+/- 400 vph	Yes	< 5	Yes
EB Eureka Rd w/o Sunrise Ave	5,440	5,569	129	2.4%	1.7	+/- 400 vph	Yes	< 5	Yes
WB Eureka Rd w/o Sunrise Ave	6,603	6,884	281	4.2%	3.4	+/- 400 vph	Yes	< 5	Yes
EB Eureka Rd e/o Sunrise Ave	4,540	4,517	-23	-0.5%	0.3	+/- 400 vph	Yes	< 5	Yes
WB Eureka Rd e/o Sunrise Ave	5,199	5,669	470	9.0%	6.4	+/- 400 vph	No	< 5	No
SB Sunrise Ave n/o Eureka Rd	2,573	2,172	-401	-15.6%	8.2	+/- 15%	No	< 5	No
NB Sunrise Ave n/o Eureka Rd	2,887	2,854	-33	-1.1%	0.6	+/- 400 vph	Yes	< 5	Yes
SB Sunrise Ave s/o Eureka Rd	2,968	2,571	-397	-13.4%	7.5	+/- 400 vph	Yes	< 5	No
NB Sunrise Ave s/o Eureka Rd	3,786	3,415	-371	-9.8%	6.2	+/- 400 vph	Yes	< 5	No
EB Douglas Blvd w/o Harding Blvd	3,619	4,160	541	14.9%	8.7	+/- 400 vph	No	< 5	No
WB Douglas Blvd w/o Harding Blvd	4,768	5,027	259	5.4%	3.7	+/- 400 vph	Yes	< 5	Yes
EB Douglas Blvd e/o Harding Blvd	5,056	5,665	609	12.0%	8.3	+/- 400 vph	No	< 5	No
WB Douglas Blvd e/o Harding Blvd	5,967	5,737	-230	-3.9%	3.0	+/- 400 vph	Yes	< 5	Yes
SB Harding Blvd n/o Douglas Blvd	3,376	2,632	-744	-22.0%	13.6	+/- 400 vph	No	< 5	No
NB Harding Blvd n/o Douglas Blvd	2,470	1,891	-579	-23.4%	12.4	+/- 15%	No	< 5	No
SB Harding Blvd s/o Douglas Blvd	415	454	39	9.3%	1.9	+/- 100 vph	Yes	< 5	Yes
NB Harding Blvd s/o Douglas Blvd	473	508	35	7.3%	1.6	+/- 100 vph	Yes	< 5	Yes
EB Douglas Blvd w/o Sunrise Ave	7,692	7,814	122	1.6%	1.4	+/- 400 vph	Yes	< 5	Yes
WB Douglas Blvd w/o Sunrise Ave	9,202	8,682	-521	-5.7%	5.5	+/- 400 vph	No	< 5	No
EB Douglas Blvd e/o Sunrise Ave	6,883	7,007	124	1.8%	1.5	+/- 400 vph	Yes	< 5	Yes
WB Douglas Blvd e/o Sunrise Ave	7,717	7,699	-18	-0.2%	0.2	+/- 400 vph	Yes	< 5	Yes
SB Sunrise Ave n/o Douglas Blvd	3,697	3,860	163	4.4%	2.6	+/- 400 vph	Yes	< 5	Yes
NB Sunrise Ave n/o Douglas Blvd	3,461	3,650	189	5.4%	3.2	+/- 400 vph	Yes	< 5	Yes
SB Sunrise Ave s/o Douglas Blvd	3,085	1,925	-1160	-37.6%	23.2	+/- 400 vph	No	< 5	No
NB Sunrise Ave s/o Douglas Blvd	3,525	3,544	19	0.5%	0.3	+/- 400 vph	Yes	< 5	Yes
EB Woodside Dr e/o Pacific St	580	617	37	6.4%	1.5	+/- 100 vph	Yes	< 5	Yes
WB Woodside Dr e/o Pacific St	370	347	-23	-6.3%	1.2	+/- 100 vph	Yes	< 5	Yes
SB Pacific St n/o Woodside Dr	3,154	3,268	114	3.6%	2.0	+/- 400 vph	Yes	< 5	Yes
NB Pacific St n/o Woodside Dr	4,234	4,198	-36	-0.9%	0.6	+/- 400 vph	Yes	< 5	Yes
SB Pacific St s/o Woodside Dr	3,220	3,306	86	2.7%	1.5	+/- 400 vph	Yes	< 5	Yes
NB Pacific St s/o Woodside Dr	4,510	4,506	-4	-0.1%	0.1	+/- 400 vph	Yes	< 5	Yes
EB Sunset Blvd w/o Pacific St	3,589	3,923	334	9.3%	5.4	+/- 400 vph	Yes	< 5	No
WB Sunset Blvd w/o Pacific St	4,959	5,288	329	6.6%	4.6	+/- 400 vph	Yes	< 5	Yes
EB Sunset Blvd e/o Pacific St	705	545	-160	-22.8%	6.4	+/- 15%	No	< 5	No
WB Sunset Blvd e/o Pacific St	852	761	-92	-10.7%	3.2	+/- 15%	Yes	< 5	Yes
SB Pacific St n/o Sunset Blvd	3,840	3,919	79	2.1%	1.3	+/- 400 vph	Yes	< 5	Yes
NB Pacific St n/o Sunset Blvd	3,656	3,656	-1	0.0%	0.0	+/- 400 vph	Yes	< 5	Yes
SB Pacific St s/o Sunset Blvd	3,102	3,250	148	4.8%	2.6	+/- 400 vph	Yes	< 5	Yes
NB Pacific St s/o Sunset Blvd	4,141	4,136	-6	-0.1%	0.1	+/- 400 vph	Yes	< 5	Yes
EB Rocklin Rd w/o Granite Dr	3,081	3,143	62	2.0%	1.1	+/- 400 vph	Yes	< 5	Yes
WB Rocklin Rd w/o Granite Dr	3,512	3,862	350	10.0%	5.8	+/- 400 vph	Yes	< 5	No
EB Rocklin Rd e/o Granite Dr	4,132	4,045	-87	-2.1%	1.4	+/- 400 vph	Yes	< 5	Yes
WB Rocklin Rd e/o Granite Dr	4,491	4,579	88	2.0%	1.3	+/- 400 vph	Yes	< 5	Yes
SB Granite Dr n/o Rocklin Rd	2,645	2,362	-283	-10.7%	5.7	+/- 15%	Yes	< 5	No
NB Granite Dr n/o Rocklin Rd	2,633	2,212	-422	-16.0%	8.6	+/- 15%	No	< 5	No
EB Rocklin Rd w/o WB I-80	4,238	4,193	-45	-1.1%	0.7	+/- 400 vph	Yes	< 5	Yes
WB Rocklin Rd w/o WB I-80	4,736	4,774	38	0.8%	0.6	+/- 400 vph	Yes	< 5	Yes
EB Rocklin Rd e/o WB I-80	2,597	2,516	-81	-3.1%	1.6	+/- 15%	Yes	< 5	Yes
WB Rocklin Rd e/o WB I-80	5,911	6,059	148	2.5%	1.9	+/- 400 vph	Yes	< 5	Yes
EB Rocklin Rd e/o EB I-80	4,246	4,236	-10	-0.2%	0.2	+/- 400 vph	Yes	< 5	Yes
EB Rocklin Rd e/o EB I-80	4,155	4,060	-95	-2.3%	1.5	+/- 400 vph	Yes	< 5	Yes
EB Rocklin Rd w/o Aguilar Rd	4,373	4,294	-79	-1.8%	1.2	+/- 400 vph	Yes	< 5	Yes
WB Rocklin Rd w/o Aguilar Rd	4,217	3,843	-374	-8.9%	5.9	+/- 400 vph	Yes	< 5	No
EB Rocklin Rd e/o Aguilar Rd	3,705	3,529	-176	-4.8%	2.9	+/- 400 vph	Yes	< 5	Yes
WB Rocklin Rd e/o Aguilar Rd	3,722	3,546	-176	-4.7%	2.9	+/- 400 vph	Yes	< 5	Yes

SB Aguilar Rd s/o Rocklin Rd	497	446	-51	-10.2%	2.3	+/- 100 vph	Yes	< 5	Yes
NB Aguilar Rd s/o Rocklin Rd	324	297	-27	-8.3%	1.5	+/- 100 vph	Yes	< 5	Yes
Overall	1,749,267	1,748,116	-1,151	-0.1%	0.9	+/- 5%	Yes	< 4	Yes

Link Volumes		
	Target	% Met
< 700 vph	> 85 %	96%
> 700 & < 2,700 vph	> 85 %	96%
> 2,700 vph	> 85 %	100%
GEH Statistic	> 85 %	86%

Aggregated Volumes		
	Target	Modeled
Intersections	> 85 %	93%
Interchanges	> 85 %	100%

VISSIM Metrics
 Calibration Comparison
 I-80/SR 65 Interchange
 Fehr & Peers
 Travel Time
 February 21, 2013

PM Peak Period

Path	Time Period	Measured	Modeled Conditions			Calibration Targets ¹	
		Travel Time (minutes)	Travel Time (minutes)	Difference (minutes)	Percent Difference	Target	Meets Target?
I-80 WB: Blue Oaks Blvd to Antelope Road	4:00 - 4:15	8.17	8.27	0.10	1.3%	+/- 15%	Yes
	4:30 - 4:45	8.03	8.41	0.38	4.7%	+/- 15%	Yes
	5:00 - 5:15	8.27	8.41	0.14	1.7%	+/- 15%	Yes
	5:45 - 6:00	9.03	8.20	-0.83	-9.2%	+/- 15%	Yes
	6:15 - 6:30	8.05	8.05	0.00	0.0%	+/- 15%	Yes
I-80 EB: Antelope Road to Blue Oaks Blvd	3:45 - 4:00	7.39	9.52	2.13	28.7%	+/- 15%	No
	4:15 - 4:30	8.06	9.21	1.15	14.2%	+/- 15%	Yes
	4:45 - 5:00	8.61	10.20	1.59	18.4%	+/- 15%	No
	5:15 - 5:30	12.21	9.58	-2.63	-21.5%	+/- 15%	No
	6:00 - 6:15	9.04	8.25	-0.79	-8.7%	+/- 15%	Yes
I-80 WB: Sierra College Blvd to Antelope Road	4:00 - 4:15	8.75	8.07	-0.68	-7.8%	+/- 15%	Yes
	5:00 - 5:15	8.50	8.19	-0.31	-3.6%	+/- 15%	Yes
	5:30 - 5:45	7.30	8.10	0.80	11.0%	+/- 15%	Yes
	6:00 - 6:15	7.77	7.98	0.22	2.8%	+/- 15%	Yes
	6:30 - 6:45	7.68	7.94	0.26	3.3%	+/- 15%	Yes
I-80 EB: Antelope Road to Sierra College Blvd	4:15 - 4:30	5.84	6.55	0.71	12.1%	+/- 15%	Yes
	4:45 - 5:00	6.08	6.63	0.55	9.0%	+/- 15%	Yes
	5:15 - 5:30	6.26	6.57	0.31	4.9%	+/- 15%	Yes
	5:45 - 6:00	7.06	6.41	-0.65	-9.3%	+/- 15%	Yes

Measure	% Cases
> 85%	84%
Not Met	

VISSIM Post-Processor
 Average Values from 10 Runs
 Peak Hour Travel Time

I-80/SR 65 Interchange
 Existing Conditions
 PM Peak Period

Mode	Description	Distance (ft)	Volume (vehicles)		Travel Time (min.:sec.)		Speed (mph)
			Average	Std. Dev.	Average	Std. Dev.	Average
SOV	SR-65 at Blue Oaks to I-80 at Antelope	43,109	466	0	08:25	00:00	23.3
	I-80 at Auburn to SR-65 at Blue Oaks	32,854	1113	0	09:16	00:00	16.1
	I-80 at Sierra College to I-80 at Antelope	44,492	473	0	08:11	00:00	24.7
	I-80 at Auburn to I-80 at Sierra College	35,359	874	0	06:35	00:00	24.4
HOV	SR-65 at Blue Oaks to I-80 at Antelope	43,109	131	0	08:17	00:00	23.7
	I-80 at Auburn to SR-65 at Blue Oaks	32,854	246	0	09:11	00:00	16.3
	I-80 at Sierra College to I-80 at Antelope	44,492	160	0	08:01	00:00	25.2
	I-80 at Auburn to I-80 at Sierra College	35,359	156	0	06:23	00:00	25.2

VISSIM Post-Processor
Average Values from 10 Runs
Network Statistics

I-80/SR 65 Interchange
Existing Conditions
PM Peak Period

Network Performance	Vehicle Types	Average	Std. Dev.
Number of Vehicles Served	All Vehicles	198,170	39
Travel Distance [mi]	All Vehicles	730,101	1,288
Travel Time [h]	All Vehicles	16,851	93.9
Average Speed [mph]	All Vehicles	43.3	0.2
Total Delay [h]	All Vehicles	3,946	91.1
Average Delay per Vehicle [s]	All Vehicles	71	1.6
VHD/VMT [min/mile]	All Vehicles	0.32	0.01
Number of Vehicles Served	HOV	36,144	153
Travel Distance [mi]	HOV	135,800	858
Travel Time [h]	HOV	3,038	20
Average Speed [mph]	HOV	44.7	0.2
Total Delay [h]	HOV	652	16
Average Delay per Vehicle [s]	HOV	64	2
VHD/VMT [min/mile]	HOV	0.29	0.01
Number of Vehicles Served	Truck	2,717	49
Travel Distance [mi]	Truck	13,929	276
Travel Time [h]	Truck	297	5
Average Speed [mph]	Truck	46.9	1
Total Delay [h]	Truck	60	3
Average Delay per Vehicle [s]	Truck	78	5
VHD/VMT [min/mile]	Truck	0.26	0.02

Performance Measure	Vehicle Types		
	HOV	Truck	All
Vehicles Served	36,140	2,720	198,170
Demand Volume	35,829	2,724	195,975
Percent Demand Served	100.9%	99.9%	101.1%
Vehicle Miles of Travel	135,800	13,930	730,100
Person Miles of Travel	285,180	14,630	880,180
Vehicle Hours of Travel	3,040	300	16,850
Vehicle Hours of Delay	650	60	3,950
VHD % of VHT	21.4%	20.0%	23.4%
Average Delay per Vehicle (min)	1.08	1.32	1.20
Person Hours of Delay	1,370	60	4,670
Average Travel Speed	44.7	46.9	43.3

VISSIM Post-Processor
Average Results from 10 Runs
Freeway Operations Summary

I-80 / SR-65 Interchange
Existing Conditions
PM Peak Hour

Location	Facility Type	Mainline Volume (vph)			On-ramp Volume (vph)			Off-ramp Volume (vph)			Speed (mph)		Density (vplpm)		LOS
		Avg.	St. Dev.	%	Avg.	St. Dev.	%	Avg.	St. Dev.	%	Avg.	St. Dev.	Avg.	St. Dev.	
1 I-80 EB - Auburn Blvd On-ramp	Merge	6,296	44	101.8%	649	10	92.6%				60.1	1.4	24.2	0.6	C
2 I-80 EB - Auburn Blvd to Douglas Blvd	Basic	6,935	67	100.7%							55.6	2.9	39.4	2.1	E
3 I-80 EB - Douglas Blvd EB Off-ramp	Diverge	6,929	75	100.6%				1,171	72	102.3%	62.2	0.3	22.3	0.4	C
4 I-80 EB - Douglas Blvd WB Off-ramp	Diverge	5,760	93	100.4%				410	37	106.1%	62.6	1.8	18.0	1.1	B
5 I-80 EB - Douglas Blvd Off to On-ramp	Basic	5,351	79	100.0%							62.7	2.3	22.7	2.8	C
6 I-80 EB - Douglas Blvd On-ramp	Merge	5,349	86	99.9%	1,192	45	102.4%				56.7	7.3	30.5	9.1	D
7 I-80 EB - Eureka Rd Off-ramp	Diverge	6,549	128	100.5%				890	55	94.6%	52.0	9.2	46.4	19.6	F
8 I-80 EB - Eureka Rd Off to On-ramp	Basic	5,670	133	101.7%							62.0	1.7	23.3	0.8	C
9 I-80 EB - Eureka Rd EB On-ramp	Merge	5,670	127	101.7%	297	33	129.6%				62.0	0.4	19.5	1.5	B
10 I-80 EB - Eureka Rd to Taylor Rd	Weave	5,965	124	102.7%	977	55	108.7%	539	37	106.0%	48.1	12.4	38.8	15.7	E
11 I-80 EB - Taylor Rd to SR-65	Basic	6,412	147	103.5%							44.4	9.8	39.5	11.3	E
17 I-80 EB - SR-65 Off-ramp	Diverge	6,416	153	103.5%				3,181	94	99.8%	44.3	6.6	51.6	13.4	F
18 I-80 EB - SR-65 Off to On-ramp	Basic	3,231	108	107.4%							63.9	0.2	16.8	0.8	B
19 I-80 EB - SR-65 On-ramp	Merge	3,230	108	107.4%	1,581	89	100.0%				60.8	3.8	22.4	1.6	C
20 I-80 EB - SR-65 to Lane Drop	Basic	4,809	150	104.7%							58.5	3.3	27.5	1.5	D
21 I-80 EB - Lane Drop to Rocklin Rd	Basic	4,803	150	104.6%							61.7	0.5	26.9	0.6	D
22 I-80 EB - Rocklin Rd Off-ramp	Diverge	4,803	151	104.6%				1,217	65	107.4%	61.0	1.0	23.8	0.7	C
23 I-80 EB - Rocklin Rd Off to On-ramp	Basic	3,586	138	103.7%							63.1	0.4	20.2	0.8	C
24 I-80 EB - Rocklin Rd On-ramp	Merge	3,587	138	103.7%	267	26	104.8%				61.5	0.7	19.0	0.9	B
25 I-80 EB - Rocklin Rd to Sierra College Blvd	Basic	3,857	147	103.9%							63.5	0.2	20.7	0.8	C

Notes: Average density reported for the analysis area only: for example, within the ramp influence area and not including the HOV lane.
Mainline volume is the upstream served volume for all lanes.

VISSIM Post-Processor
Average Results from 10 Runs
Freeway Operations Summary

I-80 / SR-65 Interchange
Existing Conditions
PM Peak Hour

	Location	Facility Type	Mainline Volume (vph)			On-ramp Volume (vph)			Off-ramp Volume (vph)			Speed (mph)		Density (vplpm)		LOS
			Avg.	St. Dev.	%	Avg.	St. Dev.	%	Avg.	St. Dev.	%	Avg.	St. Dev.	Avg.	St. Dev.	
26	I-80 EB - Sierra College Blvd Off-ramp	Diverge	3,857	147	103.9%				374	41	131.6%	62.2	1.3	21.8	0.9	C
27	I-80 EB - Sierra College Blvd Off to On-ramp	Basic	3,482	138	101.5%							63.3	0.5	19.6	0.6	C
28	I-80 EB - Sierra College Blvd SB On-ramp	Merge	3,481	132	101.5%	236	6	107.2%				62.5	0.4	18.2	0.7	B
29	I-80 EB - Sierra College Blvd NB On-ramp	Merge	3,720	121	101.9%	464	9	102.0%				59.7	1.1	21.0	0.9	C
38	I-80 WB - Sierra College Blvd Off-ramp	Diverge	3,241	18	106.0%				490	42	104.5%	60.7	0.8	16.5	0.3	B
39	I-80 WB - Sierra College Blvd Off to On-ramp	Basic	2,749	52	106.3%							63.7	0.2	16.4	0.3	B
40	I-80 WB - Sierra College Blvd NB On-ramp	Merge	2,747	54	106.2%	70	3	100.4%				63.6	0.1	14.2	0.3	B
41	I-80 WB - Sierra College Blvd SB On-ramp	Merge	2,819	60	106.1%	293	7	122.0%				61.5	0.6	15.3	0.4	B
42	I-80 WB - Sierra College Blvd to Rocklin Rd	Basic	3,106	60	107.2%							63.8	0.1	16.8	0.4	B
43	I-80 WB - Rocklin Rd Off-ramp	Diverge	3,104	63	107.2%				273	28	101.3%	63.2	0.3	19.4	0.5	B
44	I-80 WB - Rocklin Rd Off to On-ramp	Basic	2,831	64	107.7%							63.4	0.2	17.0	0.3	B
45	I-80 WB - Rocklin Rd On-ramp	Merge	2,829	59	107.7%	1,080	60	111.2%				50.8	1.6	24.0	1.5	C
46	I-80 WB - Rocklin Rd to HOV Lane Start	Basic	3,912	80	108.7%							61.8	0.4	24.2	0.6	C
47	I-80 WB - HOV Lane Start to SR-65	Basic	3,904	69	108.5%							63.2	0.2	16.2	0.2	B
48	I-80 WB - SR-65 Off-ramp	Diverge	3,903	67	108.4%				1,258	53	107.3%	52.6	9.9	45.9	31.7	F
49	I-80 WB - SR-65 Off to On-ramp	Basic	2,632	67	108.4%							63.8	0.2	14.9	0.3	B
50	I-80 WB - SR-65 On-ramp	Merge	2,740	78	112.9%	2,498	96	102.3%				63.5	0.1	20.6	0.6	C

Notes: Average density reported for the analysis area only: for example, within the ramp influence area and not including the HOV lane.
Mainline volume is the upstream served volume for all lanes.

VISSIM Post-Processor
Average Results from 10 Runs
Freeway Operations Summary

I-80 / SR-65 Interchange
Existing Conditions
PM Peak Hour

	Location	Facility	Mainline Volume (vph)			On-ramp Volume (vph)			Off-ramp Volume (vph)			Speed (mph)		Density (vplpm)		LOS
		Type	Avg.	St. Dev.	%	Avg.	St. Dev.	%	Avg.	St. Dev.	%	Avg.	St. Dev.	Avg.	St. Dev.	
60	I-80 WB - Taylor Rd On-ramp	Merge	5,126	109	105.2%	470	34	104.6%				62.8	0.1	23.7	0.5	C
61	I-80 WB - Atlantic St WB Off-ramp	Diverge	5,589	122	105.1%				422	46	113.0%	64.0	0.4	21.1	0.7	C
62	I-80 WB - Atlantic St EB Off-ramp	Diverge	5,169	110	104.5%				682	58	103.0%	60.3	1.8	26.8	0.9	C
63	I-80 WB - Atlantic St Off to On-ramp	Basic	4,489	122	104.8%							63.4	0.3	17.7	0.6	B
64	I-80 WB - Atlantic St On-ramp	Merge	4,490	123	104.8%	1,126	65	114.6%				61.1	1.4	21.6	0.8	C
65	I-80 WB - Douglas Blvd Off-ramp	Diverge	5,616	145	106.6%				956	71	107.0%	60.6	2.3	17.6	0.7	B
66	I-80 WB - Douglas Rd Off to On-ramp	Basic	4,656	105	106.4%							62.3	1.2	25.6	0.7	C
67	I-80 WB - Douglas Blvd WB On-ramp	Merge	4,656	103	106.5%	1,029	61	89.5%				49.7	3.1	33.5	3.3	D
68	I-80 WB - Douglas Blvd EB On-ramp	Merge	5,683	125	102.9%	524	41	113.6%				49.5	3.6	37.1	2.6	E
69	I-80 WB - Douglas Blvd to Riverside Ave	Basic	6,198	135	103.6%							62.8	0.1	31.4	0.7	D
70	I-80 WB - Riverside Ave Off-ramp	Diverge	6,199	132	103.6%				759	59	101.6%	57.3	2.8	36.1	2.4	E
71	I-80 WB - Riverside Ave Off to On-ramp	Basic	5,446	118	104.0%							61.5	0.6	28.4	0.7	D
72	I-80 WB - Riverside Ave NB On-ramp	Merge	5,443	122	103.9%	199	7	99.4%				63.3	0.1	17.9	0.6	B
73	I-80 WB - Riverside Ave SB On-ramp	Merge	5,639	124	103.7%	985	11	110.5%				62.9	0.5	21.7	0.6	C
74	I-80 WB - Riverside Ave to Antelope Rd	Basic	6,612	138	104.5%							63.1	0.1	25.9	0.6	C
75	I-80 WB - Antelope Rd Off-ramp	Diverge	6,604	137	104.4%				959	40	102.6%	56.7	2.7	31.1	1.7	D

Notes: Average density reported for the analysis area only: for example, within the ramp influence area and not including the HOV lane.
Mainline volume is the upstream served volume for all lanes.

VISSIM Post-Processor
Average Results from 10 Runs
Freeway Operations Summary

I-80 / SR 65 Interchange
Existing Conditions
PM Peak Hour

	Location	Facility	Mainline Volume (vph)			On-ramp Volume (vph)			Off-ramp Volume (vph)			Speed (mph)		Density (vplpm)		LOS
		Type	Avg.	St. Dev.	%	Avg.	St. Dev.	%	Avg.	St. Dev.	%	Avg.	St. Dev.	Avg.	St. Dev.	
76	I-80 WB - Antelope Rd Off to On-ramp	Basic	5,632	145	104.4%							59.7	0.8	23.4	0.6	C
77	I-80 WB - Antelope Rd WB On-ramp	Merge	5,633	143	104.5%	321	8	97.7%				60.5	0.9	22.0	1.0	C
78	I-80 WB - Antelope Rd to Truck Scales	Weave	5,948	138	104.0%	261	5	99.7%	19	10		62.9	0.2	22.1	0.5	C
79	I-80 WB - Truck Scales Off to On-ramp	Basic	6,180	135	103.3%							63.2	0.1	23.7	0.5	C
80	I-80 WB - Truck Scales On-ramp	Merge	6,631	147	110.9%	19	10					63.0	0.1	22.9	0.7	C
81	I-80 WB - Truck Scales to Elkhorn Blvd	Basic	6,189	144	103.5%							63.0	0.2	23.8	0.7	C
82	I-80 WB - Elkhorn Blvd Off-ramp	Diverge	6,190	143	103.5%				1,011	56	99.0%	58.3	1.6	26.1	1.0	C
83	I-80 WB - Elkhorn Blvd Off to On-ramp	Basic	5,174	150	104.3%							61.6	0.8	20.6	0.7	C
84	I-80 WB - Elkhorn Blvd WB On-ramp	Merge	5,175	148	104.4%	708	9	106.9%				58.8	0.7	20.7	0.7	C
85	I-80 WB - Elkhorn Blvd EB On-ramp	Merge	5,875	152	104.5%	605	9	105.6%				62.7	0.7	24.0	0.5	C

Notes: Average density reported for the analysis area only: for example, within the ramp influence area and not including the HOV lane.
Mainline volume is the upstream served volume for all lanes.

VISSIM Post-Processor
Average Results from 10 Runs
Freeway Operations Summary

I-80 / SR-65 Interchange
Existing Conditions
PM Peak Hour

	Location	Facility Type	Mainline Volume (vph)			On-ramp Volume (vph)			Off-ramp Volume (vph)			Speed (mph)		Density (vplpm)		LOS
			Avg.	St. Dev.	%	Avg.	St. Dev.	%	Avg.	St. Dev.	%	Avg.	St. Dev.	Avg.	St. Dev.	
97	SR-65 SB - Twelve Bridges Dr Off-ramp	Diverge	1,745	43	101.6%				210	26	101.3%	63.8	0.2	12.4	0.3	B
98	SR-65 SB - Twelve Bridges Dr Off to On-ramp	Basic	1,532	38	101.5%							63.6	0.3	12.7	0.3	B
99	SR-65 SB - Twelve Bridges Dr On-ramp	Merge	1,532	39	101.4%	388	26	101.8%				57.7	0.9	14.9	0.5	B
100	SR-65 SB - Twelve Bridges Dr to Sunset Blvd	Basic	1,928	53	102.0%							63.2	0.3	15.9	0.6	B
101	SR-65 SB - Sunset Blvd Off-ramp	Diverge	1,930	56	102.1%				268	27	109.8%	63.3	0.3	14.7	0.4	B
102	SR-65 SB - Sunset Blvd Off to On-ramp	Basic	1,660	52	100.8%							63.3	0.3	13.4	0.5	B
103	SR-65 SB - Sunset Blvd WB On-ramp	Merge	1,662	53	100.9%	547	24	108.1%				56.1	1.6	17.6	0.8	B
104	SR-65 SB - Sunset Blvd EB On-ramp	Merge	2,210	59	102.7%	617	32	102.8%				62.4	0.3	22.0	0.6	C
105	SR-65 SB - Sunset Blvd to Blue Oaks Blvd	Basic	2,821	77	102.5%							62.4	0.3	23.3	0.6	C
106	SR-65 SB - Blue Oaks Blvd Off-ramp	Diverge	2,822	74	102.5%				528	41	97.5%	60.7	1.6	23.8	0.8	C
107	SR-65 SB - Blue Oaks Blvd Off to On-ramp	Basic	2,294	75	103.8%							62.6	0.6	19.4	0.8	C
108	SR-65 SB - Blue Oaks Blvd WB On-ramp	Merge	2,293	74	103.7%	282	24	76.1%				60.2	1.0	19.7	0.6	B
109	SR-65 SB - Blue Oaks Blvd to Pleasant Grove Blvd	Weave	2,578	74	99.9%	907	45	97.7%	559	42	99.2%	60.8	0.3	21.1	0.6	C
110	SR-65 SB - Pleasant Grove Blvd Off to On-ramp	Basic	2,922	101	99.2%							61.9	0.8	25.0	0.8	C
111	SR-65 SB - Pleasant Grove Blvd WB On-ramp	Merge	2,922	97	99.1%	352	25	117.6%				51.4	4.3	31.3	3.1	D
112	SR-65 SB - Pleasant Grove Blvd EB On-ramp	Merge	3,276	94	100.9%	620	45	106.1%				47.5	3.8	38.8	4.0	E
113	SR-65 SB - Pleasant Grove Blvd to Galleria Blvd	Basic	3,895	104	101.7%							61.9	0.6	32.4	1.0	D
114	SR-65 SB - Galleria Blvd Off-ramp	Diverge	3,895	104	101.7%				831	52	105.6%	62.0	0.4	32.2	1.0	D
115	SR-65 SB - Galleria Blvd Off to Lane Add	Basic	3,060	108	100.6%							62.0	0.4	27.1	1.0	D
116	SR-65 SB - Lane Add to Galleria Blvd On-ramp	Basic	3,057	109	100.5%							63.3	0.2	19.4	0.3	C
117	SR-65 SB - Galleria Blvd On-ramp	Merge	3,057	111	100.5%	1,021	70	104.0%				55.8	2.7	24.3	1.8	C
118	SR-65 SB - I-80 WB Off-ramp	Diverge	4,079	134	101.4%				2,498	96	102.3%	62.9	0.1	21.6	0.8	C

Notes: Average density reported for the analysis area only: for example, within the ramp influence area and not including the HOV lane.
Mainline volume is the upstream served volume for all lanes.

VISSIM Post-Processor
Average Results from 10 Runs
Freeway Operations Summary

I-80 / SR-65 Interchange
Existing Conditions
PM Peak Hour

Location	Facility Type	Mainline Volume (vph)			On-ramp Volume (vph)			Off-ramp Volume (vph)			Speed (mph)		Density (vplpm)		LOS
		Avg.	St. Dev.	%	Avg.	St. Dev.	%	Avg.	St. Dev.	%	Avg.	St. Dev.	Avg.	St. Dev.	
125 SR-65 NB - I-80 WB On-ramp	Merge	3,178	94	99.7%	1,232	58	105.1%				20.8	1.5	95.2	3.8	F
126 SR-65 NB - I-80 to Stanford Ranch Rd	Basic	4,405	94	101.1%							28.7	2.7	76.5	5.7	F
127 SR-65 NB - Stanford Ranch Rd Off-ramp	Diverge	4,404	94	101.0%				1,247	56	108.8%	34.4	3.4	62.4	4.8	F
128 SR-65 NB - Stanford Ranch Rd Off to On-ramp	Basic	3,157	93	98.2%							58.7	4.8	27.4	2.6	D
129 SR-65 NB - Stanford Ranch Rd On-ramp	Merge	3,156	89	98.2%	961	57	103.9%				48.9	10.0	39.2	8.8	E
130 SR-65 NB - Stanford Ranch Rd to Pleasant Grove Blvd	Basic	4,118	113	99.5%							60.8	0.4	31.5	1.1	D
131 SR-65 NB - Pleasant Grove Blvd Off-ramp	Diverge	4,118	113	99.5%				1,109	69	109.8%	62.2	0.2	27.9	0.9	C
132 SR-65 NB - Pleasant Grove Blvd Off to On-ramp	Basic	3,010	116	96.2%							63.2	0.2	24.2	1.1	C
133 SR-65 NB - Pleasant Grove Blvd to Blue Oaks Blvd	Weave	3,012	115	96.3%	516	51	94.5%	1,061	67	90.4%	63.1	0.1	21.3	0.9	C
134 SR-65 NB - Blue Oaks Blvd Off to On-ramp	Basic	2,465	99	98.6%							63.1	0.4	20.1	1.1	C
135 SR-65 NB - Blue Oaks Blvd On-ramp	Merge	2,464	103	98.6%	528	33	110.2%				56.2	2.7	24.5	2.2	C
136 SR-65 NB - Blue Oaks Blvd to Sunset Blvd	Basic	2,991	116	100.4%							62.7	0.2	25.3	0.9	C
137 SR-65 NB - Sunset Blvd Off-ramp	Diverge	2,988	111	100.3%				651	54	94.4%	62.9	0.1	22.7	0.7	C
138 SR-65 NB - Sunset Blvd Off to On-ramp	Basic	2,334	97	101.9%							63.2	0.2	19.7	0.8	C
139 SR-65 NB - Sunset Blvd EB On-ramp	Merge	2,330	99	101.7%	66	14	93.7%				62.3	0.3	20.0	0.8	C
140 SR-65 NB - Sunset Blvd WB On-ramp	Merge	2,395	94	101.5%	274	24	102.2%				62.8	0.3	19.5	0.8	B
141 SR-65 NB - Sunset Blvd to Twelve Bridges Dr	Basic	2,667	92	101.5%							62.5	0.2	23.1	0.7	C
142 SR-65 NB - Twelve Bridges Dr Off-ramp	Diverge	2,657	95	101.1%				508	48	89.5%	61.9	0.3	23.3	0.8	C
143 SR-65 NB - Twelve Bridges Dr Off to On-ramp	Basic	2,146	82	104.2%							63.0	0.1	18.6	0.5	C
144 SR-65 NB - Twelve Bridges Dr On-ramp	Merge	2,147	81	104.2%	238	23	81.1%				62.1	0.4	19.6	0.5	B

Notes: Average density reported for the analysis area only: for example, within the ramp influence area and not including the HOV lane.
Mainline volume is the upstream served volume for all lanes.

VISSIM Post-Processor
Average Results from 10 Runs
Intersection Volume and Delay

I-80 / SR-65 Interchange
Existing Conditions
PM Peak Hour

	Intersection	Control	Volume (vph)		Percent Served	Delay (sec/veh)		Level of Service
			Demand	Served		Average	Std. Dev.	
1	SR-65 /Sterling Parkway	Signal	4,125	4,171	101.1%	18.0	2.6	B
2	SR-65 SB Ramps/Twelve Bridges Dr	Signal	1,055	970	91.9%	4.6	0.5	A
3	SR-65 NB Ramps/Twelve Bridges Dr	Signal	1,520	1,431	94.1%	3.0	0.3	A
4	SR-65 SB Ramps/Sunset Blvd	Signal	2,112	2,131	100.9%	6.0	0.2	A
5	SR-65 NB Ramps/Sunset Blvd	Signal	2,081	2,125	102.1%	9.3	0.4	A
6	SR-65 SB Ramps-Washington Blvd/Blue Oaks	Signal	4,225	4,384	103.8%	32.8	3.3	C
7	SR-65 NB Ramps/Blue Oaks Blvd	Signal	2,891	2,954	102.2%	22.6	1.3	C
8	SR-65 SB Ramps/Pleasant Grove Blvd	Signal	4,642	4,705	101.3%	7.9	0.6	A
9	SR-65 NB Ramps/Pleasant Grove Blvd	Signal	4,337	4,496	103.7%	14.2	1.0	B
10	Stanford Ranch Rd/Five Star Blvd	Signal	4,292	4,370	101.8%	32.0	2.0	C
11	SR-65 NB Ramps/Stanford Ranch Rd	Signal	5,088	5,350	105.1%	15.2	2.1	B
12	SR-65 SB Ramps/Galleria Blvd	Signal	5,081	5,279	103.9%	19.3	1.6	B
13	Galleria Blvd/Antelope Creek Dr	Signal	4,480	4,526	101.0%	24.4	2.1	C
14	Galleria Blvd/Roseville Pkwy	Signal	6,853	7,146	104.3%	36.4	1.6	D
15	Creekside Ridge Dr/Roseville Pkwy	Signal	4,484	4,508	100.5%	17.4	2.1	B
16	Taylor Rd/East Roseville Pkwy	Signal	5,875	5,808	98.9%	28.3	3.5	C
17	North Sunrise Ave/East Roseville Pkwy	Signal	5,080	5,030	99.0%	37.3	3.1	D
18	Wills Rd/Atlantic St	Signal	2,312	2,514	108.7%	12.3	1.2	B
19	I-80 WB Ramps/Atlantic St	Signal	3,239	3,595	111.0%	10.9	0.6	B
20	Taylor Rd-I-80 EB Ramps/Eureka Rd	Signal	4,818	5,175	107.4%	60.6	11.0	E
21	North Sunrise Ave/Eureka Rd	Signal	4,692	4,869	103.8%	29.9	1.9	C
22	Harding Blvd/Wills Rd	Signal	2,793	3,018	108.0%	13.4	1.1	B
23	Harding Blvd/Douglas Blvd	Signal	3,536	3,596	101.7%	27.7	1.8	C
24	I-80 WB Ramps/Douglas Blvd	Signal	4,479	4,480	100.0%	16.7	1.8	B

Network Summary	
Total Demand Volume (veh/hr)	94,090
Total Volume Served (veh/hr)	96,629
Percent Served	102.7%

- Notes: 1. Volume is measured for the entire peak hour.
2. Delay is measured for the peak 15 minutes in the peak hour.

**VISSIM Post-Processor
Average Results from 10 Runs
Intersection Volume and Delay**

**I-80 / SR 65 Interchange
Existing Conditions
PM Peak Hour**

Intersection	Control	Volume (vph)		Percent Served	Delay (sec/veh)		Level of Service	
		Demand	Served		Average	Std. Dev.		
25	I-80 EB Ramps/Douglas Blvd	Signal	5,030	5,060	100.6%	5.8	0.6	A
26	North Sunrise Ave/Douglas Blvd	Signal	5,999	6,144	102.4%	35.4	1.7	D
27	Pacific St/Woodside Dr	Signal	2,211	2,202	99.6%	6.1	1.1	A
28	Pacific St/Sunset Blvd	Signal	3,385	3,465	102.4%	28.9	2.5	C
29	Granite Dr/Rocklin Rd	Signal	2,870	2,919	101.7%	36.5	2.3	D
30	I-80 WB Ramps/Rocklin Rd	Signal	2,935	3,092	105.3%	16.9	1.0	B
31	I-80 EB Ramps/Rocklin Rd	Signal	2,844	2,993	105.2%	20.0	1.0	B
32	Aguilar Rd/Rocklin Rd	Signal	2,132	2,137	100.2%	13.2	9.2	B
253	Galleria Blvd/Berry St	Signal	2,522	2,726	108.1%	8.6	1.1	A

Network Summary	
Total Demand Volume (veh/hr)	29,928
Total Volume Served (veh/hr)	30,737
Percent Served	102.7%

- Notes: 1. Volume is measured for the entire peak hour.
 2. Delay is measured for the peak 15 minutes in the peak hour.

SR 65 Capacity and Operational Improvements

**Vissim Model Results – Design Year
Alternative 1 (Carpool Lane)**

VISSIM Post-Processor
Average Values from 10 Runs
Network Statistics

SR 65 Widening
Design Year - HOV Lane Alternative
AM Peak Period

Network Performance	Vehicle Types	Average	Std. Dev.
Number of Vehicles Served	All Vehicles	208,159	165
Travel Distance [mi]	All Vehicles	940,218	1,802
Travel Time [h]	All Vehicles	21,708	210.4
Average Speed [mph]	All Vehicles	43.3	0.4
Total Delay [h]	All Vehicles	5,539	208.7
Average Delay per Vehicle [s]	All Vehicles	94	3.5
VHD/VMT [min/mile]	All Vehicles	0.35	0.01
Number of Vehicles Served	HOV	34,962	45
Travel Distance [mi]	HOV	155,430	743
Travel Time [h]	HOV	3,347	31
Average Speed [mph]	HOV	46.4	0.4
Total Delay [h]	HOV	699	29
Average Delay per Vehicle [s]	HOV	71	3
VHD/VMT [min/mile]	HOV	0.27	0.01
Number of Vehicles Served	Truck	7,584	18
Travel Distance [mi]	Truck	42,929	371
Travel Time [h]	Truck	972	16
Average Speed [mph]	Truck	44.2	1
Total Delay [h]	Truck	240	13
Average Delay per Vehicle [s]	Truck	111	6
VHD/VMT [min/mile]	Truck	0.34	0.02

Performance Measure	Vehicle Types		
	HOV	Truck	All
Vehicles Served	34,960	7,580	208,160
Demand Volume	35,840	8,220	210,080
Percent Demand Served	97.5%	92.2%	99.1%
Vehicle Miles of Travel	155,430	42,930	940,220
Person Miles of Travel	326,400	45,080	1,113,340
Vehicle Hours of Travel	3,350	970	21,710
Vehicle Hours of Delay	700	240	5,540
VHD % of VHT	20.9%	24.7%	25.5%
Average Delay per Vehicle (min)	1.20	1.90	1.60
Person Hours of Delay	1,470	250	6,320
Average Travel Speed	46.4	44.2	43.3

VISSIM Post-Processor
Average Values from 10 Runs
Peak Hour Travel Time

SR 65 Widening
Design Year - HOV Lane Alternative
AM Peak Period

Mode	Description	Distance (ft)	Volume (vehicles)		Travel Time (min.:sec.)		Speed (mph)
			Average	Std. Dev.	Average	Std. Dev.	Average
SOV	SR-65 at Blue Oaks to I-80 at Antelope	43,087	1014	16	08:35	00:12	22.8
	I-80 at Auburn to SR-65 at Blue Oaks	32,845	1747	18	06:25	00:02	23.3
	I-80: Sierra College to Antelope	45,844	1239	14	08:27	00:10	24.7
	I-80: Auburn to Sierra College	36,738	793	13	06:40	00:02	25.1
	SR-65: I-80 to Sunset	43,097	1342	15	04:12	00:01	46.6
	SR-65: Sunset to Ferrari Ranch	45,833	441	10	03:31	00:00	59.3
	SR-65: Ferrari Ranch to Sunset	36,734	1300	11	03:37	00:02	46.2
	SR-65: Sunset to I-80	32,850	1822	22	04:12	00:03	35.5
HOV	SR-65 at Blue Oaks to I-80 at Antelope	43,087	438	9	08:23	00:03	46.6
	I-80 at Auburn to SR-65 at Blue Oaks	32,845	383	10	06:16	00:01	59.3
	I-80: Sierra College to Antelope	45,844	409	9	08:20	00:04	46.2
	I-80: Auburn to Sierra College	36,738	154	6	06:33	00:02	35.5
	SR-65: I-80 to Sunset	43,097	98	5	04:13	00:02	23.3
	SR-65: Sunset to Ferrari Ranch	45,833	51	3	03:30	00:02	23.8
	SR-65: Ferrari Ranch to Sunset	36,734	234	6	03:36	00:01	25.0
	SR-65: Sunset to I-80	32,850	537	11	04:07	00:01	25.5

VISSIM Post-Processor
Average Values from 10 Runs
Network Statistics

SR 65 Widening
Design Year - HOV Lane Alternative
PM Peak Period

Network Performance	Vehicle Types	Average	Std. Dev.
Number of Vehicles Served	All Vehicles	300,778	400
Travel Distance [mi]	All Vehicles	1,160,701	2,052
Travel Time [h]	All Vehicles	30,886	216.4
Average Speed [mph]	All Vehicles	37.6	0.3
Total Delay [h]	All Vehicles	10,468	229.4
Average Delay per Vehicle [s]	All Vehicles	123	2.8
VHD/VMT [min/mile]	All Vehicles	0.54	0.01
Number of Vehicles Served	HOV	53,198	114
Travel Distance [mi]	HOV	218,121	780
Travel Time [h]	HOV	5,387	36
Average Speed [mph]	HOV	40.5	0.3
Total Delay [h]	HOV	1,586	36
Average Delay per Vehicle [s]	HOV	105	2
VHD/VMT [min/mile]	HOV	0.44	0.01
Number of Vehicles Served	Truck	8,041	25
Travel Distance [mi]	Truck	39,639	237
Travel Time [h]	Truck	971	9
Average Speed [mph]	Truck	40.8	0
Total Delay [h]	Truck	287	8
Average Delay per Vehicle [s]	Truck	126	3
VHD/VMT [min/mile]	Truck	0.44	0.01

Performance Measure	Vehicle Types		
	HOV	Truck	All
Vehicles Served	53,200	8,040	300,780
Demand Volume	54,330	8,650	301,970
Percent Demand Served	97.9%	92.9%	99.6%
Vehicle Miles of Travel	218,120	39,640	1,160,700
Person Miles of Travel	458,050	41,620	1,402,610
Vehicle Hours of Travel	5,390	970	30,890
Vehicle Hours of Delay	1,590	290	10,470
VHD % of VHT	29.5%	29.9%	33.9%
Average Delay per Vehicle (min)	1.79	2.16	2.09
Person Hours of Delay	3,340	300	12,230
Average Travel Speed	40.5	40.8	37.6

VISSIM Post-Processor
Average Values from 10 Runs
Peak Hour Travel Time

SR 65 Widening
Design Year - HOV Lane Alternative
PM Peak Period

Mode	Description	Distance (ft)	Volume (vehicles)		Travel Time (min.:sec.)		Speed (mph)
			Average	Std. Dev.	Average	Std. Dev.	Average
SOV	SR-65 at Blue Oaks to I-80 at Antelope	43,086	859	13	08:22	00:05	23.4
	I-80 at Auburn to SR-65 at Blue Oaks	32,847	1584	14	06:31	00:06	22.9
	I-80: Sierra College to Antelope	45,844	628	9	08:21	00:03	24.9
	I-80: Auburn to Sierra College	36,738	905	15	06:44	00:04	24.8
	SR-65: I-80 to Sunset	43,096	2036	21	04:18	00:02	45.6
	SR-65: Sunset to Ferrari Ranch	45,833	584	13	03:34	00:00	58.4
	SR-65: Ferrari Ranch to Sunset	36,734	937	12	03:31	00:00	47.6
	SR-65: Sunset to I-80	32,852	1384	19	04:07	00:04	36.3
HOV	SR-65 at Blue Oaks to I-80 at Antelope	43,086	281	7	08:18	00:03	45.6
	I-80 at Auburn to SR-65 at Blue Oaks	32,847	699	11	06:20	00:01	58.4
	I-80: Sierra College to Antelope	45,844	201	5	08:16	00:03	47.6
	I-80: Auburn to Sierra College	36,738	317	7	06:37	00:02	36.3
	SR-65: I-80 to Sunset	43,096	96	5	04:18	00:02	23.6
	SR-65: Sunset to Ferrari Ranch	45,833	102	5	03:33	00:01	23.6
	SR-65: Ferrari Ranch to Sunset	36,734	187	6	03:31	00:01	25.2
	SR-65: Sunset to I-80	32,852	282	8	04:03	00:02	25.2

VISSIM Post-Processor
Average Results from 10 Runs
Freeway Operations Summary

SR 65 Widening
Design Year - HOV Lane Alternative
AM Peak Hour

	Location	Facility Type	Mainline Volume (vph)			On-ramp Volume (vph)			Off-ramp Volume (vph)			Speed (mph)		Density (vplpm)		LOS
			Avg.	St. Dev.	%	Avg.	St. Dev.	%	Avg.	St. Dev.	%	Avg.	St. Dev.	Avg.	St. Dev.	
1	I-80 EB - Auburn Blvd On-ramp	Merge	7,491	32	110.2%	1,243	20	110.0%				58.8	3.7	34.9	2.7	D
2	I-80 EB - Auburn Blvd to Douglas Blvd	Basic	8,727	79	110.1%							55.8	4.3	39.2	3.6	E
3	I-80 EB - Douglas Blvd EB Off-ramp	Diverge	8,721	95	110.0%				1,391	75	109.6%	59.9	2.0	30.7	1.6	D
4	I-80 EB - Douglas Blvd WB Off-ramp	Diverge	7,321	114	109.9%				370	34	112.1%	61.1	1.5	26.3	1.3	C
5	I-80 EB - Douglas Blvd Off to On-ramp	Basic	6,949	116	109.8%							62.4	0.4	28.0	0.5	D
6	I-80 EB - Douglas Blvd to Eureka Rd	Weave	6,950	132	109.8%	1,167	40	95.6%	1,788	91	105.2%	62.2	0.5	27.1	0.6	C
7	I-80 EB CD - Eureka Rd to Taylor Rd/SR-65	Weave	626	43	104.3%	1,233	63	105.4%	880	43	102.3%	61.3	1.0	15.8	0.6	B
8	I-80 EB - Eureka Rd to SR-65	Basic	6,324	129	108.1%							60.7	1.6	30.3	1.2	D
9	I-80 EB - HOV Connector Off-ramp	Diverge	6,325	125	108.1%				585	49	106.3%	58.1	2.0	30.5	1.3	D
10	I-80 EB - SR-65 Off-ramp	Diverge	5,742	117	108.3%				3,311	114	107.8%	62.3	1.0	24.4	0.6	C
11	I-80 EB - SR-65 Off-ramp to Eureka Rd On-ramp	Basic	2,434	94	109.2%							63.9	0.3	15.1	0.4	B
17	I-80 EB - Eureka Rd On-ramp	Merge	2,436	92	109.2%	580	38	101.7%				62.8	0.8	15.2	0.5	B
18	I-80 EB - Eureka Rd On-ramp to SR-65 On-ramp	Basic	3,015	95	107.7%							63.7	0.3	16.7	0.5	B
19	I-80 EB - SR-65 On-ramp	Merge	3,015	97	107.7%	2,073	90	109.1%				60.2	0.3	27.5	0.8	C
20	I-80 EB - SR-65 to Rocklin Rd	Basic	5,088	124	108.2%							62.8	0.1	25.5	0.6	C
22	I-80 EB - Rocklin Rd Off-ramp	Diverge	5,109	133	108.7%				1,762	90	106.8%	63.5	0.1	24.9	0.4	C
23	I-80 EB - Rocklin Rd Off to On-ramp	Basic	3,360	103	110.2%							63.7	0.2	20.6	0.5	C
24	I-80 EB - Rocklin Rd On-ramp	Merge	3,363	102	110.3%	183	3	96.2%				60.9	1.0	22.0	0.7	C
25	I-80 EB - Rocklin Rd to Sierra College Blvd	Basic	3,552	105	109.6%							63.2	0.3	21.6	0.6	C
26	I-80 EB - Sierra College Blvd Off-ramp	Diverge	3,554	107	109.7%				684	46	114.1%	62.2	0.7	23.8	0.8	C
27	I-80 EB - Sierra College Blvd Off to On-ramp	Basic	2,874	99	108.9%							63.5	0.2	17.4	0.5	B
28	I-80 EB - Sierra College Blvd SB On-ramp	Merge	2,875	99	108.9%	140	5	93.0%				62.5	0.3	17.6	0.4	B
29	I-80 EB - Sierra College Blvd NB On-ramp	Merge	3,018	96	108.2%	522	19	106.5%				61.8	0.4	20.0	0.4	B
38	I-80 WB - Sierra College Blvd Off-ramp	Diverge	5,376	25	105.8%				1,104	66	106.1%	53.0	3.5	33.0	2.1	D
39	I-80 WB - Sierra College Blvd Off to On-ramp	Basic	4,269	69	105.7%							61.6	0.7	25.6	0.6	C
40	I-80 WB - Sierra College Blvd NB On-ramp	Merge	4,269	70	105.7%	50	4	83.0%				62.9	0.4	23.3	0.7	C
41	I-80 WB - Sierra College Blvd SB On-ramp	Merge	4,315	74	105.2%	321	15	103.4%				60.9	1.1	25.1	0.8	C
42	I-80 WB - Sierra College Blvd to Rocklin Rd	Basic	4,632	84	105.0%							62.7	0.2	26.4	0.5	D
43	I-80 WB - Rocklin Rd Off-ramp	Diverge	4,632	83	105.0%				270	25	103.7%	62.2	0.5	27.1	0.8	C
44	I-80 WB - Rocklin Rd Off to On-ramp	Basic	4,358	86	105.0%							62.7	0.2	24.8	0.5	C
45	I-80 WB - Rocklin Rd On-ramp	Merge	4,356	93	105.0%	980	48	99.0%				59.5	0.7	29.0	0.8	D
46	I-80 WB - Rocklin Rd to HOV Lane Start	Basic	5,325	111	103.6%							60.2	1.0	31.0	0.8	D
47	I-80 WB - HOV Lane Start to SR-65	Basic	5,324	117	103.6%							62.2	0.3	23.8	0.4	C
48	I-80 WB - SR-65 Off-ramp	Diverge	5,323	116	103.6%				1,699	77	104.2%	63.6	0.2	22.0	0.4	C
49	I-80 WB - SR-65 Off to On-ramp	Basic	3,615	98	103.0%							63.6	0.1	19.5	0.5	C
60	I-80 WB - SR-65 to Atlantic St	Weave	3,611	106	102.9%	5,772	128	105.9%	518	43	101.5%	57.7	0.8	27.0	0.7	C
62	I-80 WB - Atlantic St EB Off-ramp	Diverge	8,817	153	104.3%				1,289	66	103.9%	56.9	2.9	33.4	1.8	D
63	I-80 WB - Atlantic St EB Off to On-ramp	Basic	7,527	155	104.4%							61.5	1.0	28.8	0.6	D
64	I-80 WB - Atlantic St On-ramp	Merge	7,523	153	104.3%	915	50	108.9%				56.2	4.0	41.1	2.9	E
65	I-80 WB - Douglas Blvd Off-ramp	Diverge	8,431	167	104.7%				1,166	70	99.6%	61.1	0.5	35.7	0.9	E
66	I-80 WB - Douglas Blvd Off to On-ramp	Basic	7,256	174	105.5%							63.1	0.1	27.7	0.4	D
67	I-80 WB - Douglas Blvd WB On-ramp	Merge	7,256	176	105.5%	937	62	105.3%				57.9	1.9	33.2	1.4	D
68	I-80 WB - Douglas Blvd EB On-ramp	Merge	8,197	175	105.5%	462	34	110.1%				56.3	4.2	39.1	3.5	E
69	I-80 WB - Douglas Blvd to Riverside Ave	Basic	8,660	140	105.7%							61.0	0.6	34.9	0.8	D
70	I-80 WB - Riverside Ave Off-ramp	Diverge	8,674	187	105.9%				1,077	58	101.6%	62.3	0.1	35.0	0.7	D
71	I-80 WB - Riverside Ave Off to On-ramp	Basic	7,594	170	106.5%							62.7	0.1	30.0	0.6	D
72	I-80 WB - Riverside Ave NB On-ramp	Merge	7,595	167	106.5%	215	7	85.9%				62.9	0.3	27.9	0.5	C
73	I-80 WB - Riverside Ave SB On-ramp	Merge	7,812	157	105.8%	788	12	101.0%				62.3	0.8	33.7	0.6	D
74	I-80 WB - Riverside Ave to Antelope Rd	Basic	8,610	162	105.5%							60.8	1.7	34.9	1.3	D
75	I-80 WB - Antelope Rd Off-ramp	Diverge	8,613	174	105.6%				470	34	90.4%	57.1	10.3	40.3	11.6	E
76	I-80 WB - Antelope Rd Off to On-ramp	Basic	8,146	173	106.6%							55.3	14.9	43.3	23.4	E
77	I-80 WB - Antelope Rd WB On-ramp	Merge	8,153	181	106.7%	525	13	99.1%				52.9	14.5	47.9	26.4	F
78	I-80 WB - Antelope Rd to Truck Scales	Weave	8,703	202	106.5%	444	14	88.7%	95	18	86.1%	48.4	13.1	48.3	18.0	F
79	I-80 WB - Truck Scales Off to On-ramp	Basic	9,147	240	106.9%							41.4	12.2	60.5	19.2	F
80	I-80 WB - Truck Scales On-ramp	Merge	9,177	277	107.2%	95	18	86.5%				34.9	8.9	78.8	16.6	F
81	I-80 WB - Truck Scales to Elkhorn Blvd	Basic	9,352	262	107.9%							35.1	4.1	68.0	7.1	F
82	I-80 WB - Elkhorn Blvd Off-ramp	Diverge	9,372	263	108.1%				1,131	88	109.8%	34.9	2.6	59.7	4.3	F
83	I-80 WB - Elkhorn Blvd Off to On-ramp	Basic	8,347	244	109.3%							26.1	0.6	90.7	1.6	F
84	I-80 WB - Elkhorn Blvd WB On-ramp	Merge	8,390	222	109.8%	740	12	93.6%				26.6	0.7	91.4	2.9	F
85	I-80 WB - Elkhorn Blvd EB On-ramp	Merge	9,187	214	109.0%	811	18	98.9%				32.8	0.5	74.7	0.8	F

Notes: Average density reported for the analysis area only: for example, within the ramp influence area and not including the HOV lane.
Mainline volume is the upstream served volume for all lanes.

Location	Facility Type	Mainline Volume (vph)			On-ramp Volume (vph)			Off-ramp Volume (vph)			Speed (mph)		Density (vplpm)		LOS
		Avg.	St. Dev.	%	Avg.	St. Dev.	%	Avg.	St. Dev.	%	Avg.	St. Dev.	Avg.	St. Dev.	
100 SR-65 NB - EB I-80 Connector	Basic	3,312	113	107.9%							61.3	1.7	29.1	1.1	D
101 SR-65 NB - Eureka Rd On-ramp	Merge	3,313	113	107.9%	979	52	106.4%				48.6	0.2	32.2	0.8	D
102 SR-65 NB - WB I-80 Connector	Basic	1,700	78	104.3%							52.9	0.2	18.1	0.8	C
103 SR-65 NB - I-80 to Stanford Ranch Rd	Weave	4,283	111	107.3%	2,284	88	104.8%	850	46	103.7%	59.5	0.3	27.8	0.7	C
106 SR-65 NB - Stanford Ranch Rd Off to On-ramp	Basic	5,716	149	106.8%							62.6	0.2	30.8	0.8	D
107 SR-65 NB - Stanford Ranch Rd to Pleasant Grove Blvd	Weave	5,722	155	107.0%	698	25	102.7%	1,027	62	96.9%	61.7	1.1	29.6	1.1	D
110 SR-65 NB - Pleasant Grove Blvd Off to On-ramp	Basic	5,403	149	108.7%							57.6	4.5	31.7	2.0	D
111 SR-65 NB - Pleasant Grove Blvd On-ramp	Merge	5,406	140	108.8%	291	26	100.4%				61.5	0.7	30.6	0.7	D
112 SR-65 NB - Blue Oaks Blvd Off-ramp	Diverge	5,698	138	108.3%				2,210	84	110.5%	62.9	0.2	27.5	0.6	C
114 SR-65 NB - Blue Oaks Blvd Off to On-ramp	Basic	3,493	100	107.1%							63.6	0.2	20.2	0.6	C
115 SR-65 NB - Blue Oaks Blvd On-ramp	Merge	3,490	101	107.0%	643	50	100.4%				62.6	0.2	18.2	0.6	B
116 SR-65 NB - Blue Oaks Blvd to Sunset Blvd	Basic	4,131	115	105.9%							63.4	0.1	19.5	0.4	C
118 SR-65 NB - Sunset Blvd Off-ramp	Diverge	4,132	117	105.9%				1,448	72	106.4%	63.8	0.2	19.8	0.4	B
119 SR-65 NB - Sunset Blvd Off to On-ramp	Basic	2,686	88	105.7%							64.0	0.1	14.9	0.4	B
120 SR-65 NB - Sunset Blvd EB On-ramp	Merge	2,686	85	105.8%	163	20	101.8%				63.6	0.1	15.6	0.3	B
121 SR-65 NB - Sunset Blvd to Whitney Ranch Pkwy	Weave	2,852	79	105.6%	285	18	101.6%	795	51	98.1%	63.8	0.1	14.7	0.3	B
124 SR-65 NB - Whitney Ranch Pkwy Off to On-ramp	Basic	2,342	72	107.9%							64.1	0.2	13.2	0.4	B
125 SR-65 NB - Whitney Ranch Pkwy EB On-ramp	Merge	2,341	69	107.9%	522	36	106.5%				62.3	0.4	16.3	0.4	B
126 SR-65 NB - Whitney Ranch Pkwy to Twelve Bridges Dr	Weave	2,864	87	107.7%	461	19	107.1%	689	48	93.1%	63.6	0.1	15.4	0.4	B
129 SR-65 NB - Twelve Bridges Dr Off to On-ramp	Basic	2,640	81	112.4%							63.8	0.1	16.3	0.5	B
130 SR-65 NB - Twelve Bridges Dr to Lincoln Blvd	Weave	2,642	79	112.4%	944	49	107.3%	865	59	115.3%	63.0	0.4	17.1	0.3	B
133 SR-65 NB - Lincoln Blvd to Ferrari Ranch Rd	Basic	2,725	93	109.9%							63.1	0.3	21.5	0.7	C
134 SR-65 NB - Ferrari Ranch Rd Off-ramp	Diverge	2,725	91	109.9%				1,156	54	102.3%	63.7	0.1	18.2	0.5	B
135 SR-65 NB - Ferrari Ranch Rd Off to On-ramp	Basic	1,571	69	116.4%							64.0	0.1	15.2	0.5	B
136 SR-65 NB - Ferrari Ranch Rd On-ramp	Merge	1,573	68	116.5%	181	6	106.2%				62.2	0.2	15.9	0.4	B
150 SR-65 SB - Ferrari Ranch Rd Off-ramp	Diverge	2,007	32	107.9%				144	23	102.9%	63.1	0.2	25.9	0.3	C
151 SR-65 SB - Ferrari Ranch Rd Off to On-ramp	Basic	1,864	46	108.4%							63.1	0.2	24.5	0.5	C
152 SR-65 SB - Ferrari Ranch Rd WB On-ramp	Merge	1,865	44	108.4%	1,161	19	104.6%				60.6	0.3	24.8	0.3	C
153 SR-65 SB - Ferrari Ranch Rd EB On-ramp	Merge	3,027	51	107.0%	1,045	24	92.4%				58.2	1.7	28.4	0.8	D
154 SR-65 SB - Ferrari Ranch Rd to Lincoln Blvd	Basic	4,077	58	103.0%							62.1	2.2	30.5	1.4	D
156 SR-65 SB - Lincoln Blvd to Twelve Bridges Dr	Weave	4,080	65	103.0%	1,369	70	119.1%	932	56	107.1%	53.9	4.3	33.8	3.5	D
159 SR-65 SB - Twelve Bridges Dr Off to On-ramp	Basic	4,517	83	106.5%							61.8	0.8	30.1	0.6	D
160 SR-65 SB - Twelve Bridges Dr to Placer Pkwy	Weave	4,518	88	106.6%	1,206	51	112.7%	1,131	46	112.0%	60.2	1.2	30.1	0.8	D
163 SR-65 SB - Placer Pkwy Off to On-ramp	Basic	4,597	93	106.9%							62.7	0.1	28.0	0.4	D
164 SR-65 SB - Placer Pkwy WB On-ramp	Merge	4,601	92	107.0%	415	34	109.2%				61.4	0.9	31.2	0.9	D
165 SR-65 SB - Placer Pkwy to Sunset Blvd	Weave	5,016	98	107.2%	624	40	109.5%	833	64	105.4%	60.5	0.6	29.3	0.6	D
168 SR-65 SB - Sunset Blvd Off to On-ramp	Basic	4,798	115	107.6%							62.4	0.4	29.3	0.8	D
169 SR-65 SB - Sunset Blvd WB On-ramp	Merge	4,797	116	107.6%	802	33	114.6%				59.0	5.0	33.5	3.5	D
170 SR-65 SB - Sunset Blvd to Blue Oaks Blvd	Weave	5,601	127	108.5%	530	14	96.4%	1,097	56	108.6%	61.6	0.7	28.9	0.8	D
172 SR-65 SB - Blue Oaks Blvd Off to HOV Lane Start	Basic	5,033	106	107.1%							62.4	0.1	29.2	0.7	D
173 SR-65 SB - HOV Lane Start to Blue Oaks Blvd WB On-ramp	Basic	5,034	108	107.1%							62.3	0.3	29.0	0.7	D
174 SR-65 SB - Blue Oaks Blvd WB On-ramp	Merge	5,033	109	107.1%	624	40	105.7%				58.1	2.0	31.5	1.5	D
175 SR-65 SB - Blue Oaks Blvd to Pleasant Grove Blvd	Weave	5,660	107	107.0%	1,330	56	100.8%	867	65	107.0%	58.9	1.8	32.6	1.4	D
178 SR-65 SB - Pleasant Grove Blvd Off to On-ramp	Basic	6,128	120	105.7%							61.5	0.8	33.8	0.7	D
179 SR-65 SB - Pleasant Grove Blvd WB On-ramp	Merge	6,129	117	105.7%	709	36	102.7%				58.5	1.0	34.7	0.7	D
180 SR-65 SB - Pleasant Grove Blvd EB On-ramp	Merge	6,839	124	105.4%	824	38	103.0%				53.9	4.2	32.8	3.1	D
181 SR-65 SB - Pleasant Grove Blvd to Galleria Blvd	Basic	7,661	144	105.1%							59.3	2.2	35.1	1.6	E
182 SR-65 SB - Galleria Blvd Off-ramp	Diverge	7,660	145	105.1%				1,348	64	101.4%	60.3	3.8	33.3	2.6	D
183 SR-65 SB - Galleria Blvd Off to On-ramp	Basic	6,316	126	106.0%							58.5	2.2	37.4	1.8	E
184 SR-65 SB - Galleria Blvd to I-80	Weave	6,317	119	106.0%	734	29	102.0%	4,992	128	104.4%	60.3	0.7	29.9	0.7	D
187 SR-65 SB - EB I-80 Connector	Basic	2,069	90	108.9%							50.8	0.8	30.4	1.6	D
188 SR-65 SB - WB I-80 Connector	Basic	4,094	120	101.1%							54.0	0.6	27.2	1.0	D

Notes: Average density reported for the analysis area only: for example, within the ramp influence area and not including the HOV lane.
Mainline volume is the upstream served volume for all lanes.

Location	Facility Type	Mainline Volume (vph)			On-ramp Volume (vph)			Off-ramp Volume (vph)			Speed (mph)		Density (vplpm)		LOS
		Avg.	St. Dev.	%	Avg.	St. Dev.	%	Avg.	St. Dev.	%	Avg.	St. Dev.	Avg.	St. Dev.	
1 I-80 EB - Auburn Blvd On-ramp	Merge	8,026	45	102.0%	994	10	95.5%				61.8	0.7	28.9	0.4	D
2 I-80 EB - Auburn Blvd to Douglas Blvd	Basic	9,006	65	101.1%							61.8	0.3	31.9	0.4	D
3 I-80 EB - Douglas Blvd EB Off-ramp	Diverge	8,991	96	100.9%				1,137	72	98.8%	61.1	1.8	29.1	1.1	D
4 I-80 EB - Douglas Blvd WB Off-ramp	Diverge	7,840	117	101.0%				389	32	99.6%	61.9	1.5	26.0	0.9	C
5 I-80 EB - Douglas Blvd Off to On-ramp	Basic	7,455	132	101.1%							62.8	0.5	25.9	0.4	C
6 I-80 EB - Douglas Blvd to Eureka Rd	Weave	7,454	143	101.1%	1,743	29	92.7%	1,710	66	101.2%	62.3	0.3	26.8	0.4	C
7 I-80 EB CD - Eureka Rd to Taylor Rd/SR-65	Weave	1,067	49	103.5%	1,602	70	99.5%	1,303	70	102.6%	60.5	1.6	19.8	1.0	B
8 I-80 EB - Eureka Rd to SR-65	Basic	7,482	159	99.0%							60.9	1.1	30.7	0.7	D
9 I-80 EB - HOV Connector Off-ramp	Diverge	7,479	156	98.9%				1,065	51	95.9%	56.7	1.7	32.2	1.0	D
10 I-80 EB - SR-65 Off-ramp	Diverge	6,412	128	99.4%				3,650	94	100.8%	62.4	0.9	24.4	0.4	C
11 I-80 EB - SR-65 Off-ramp to Eureka Rd On-ramp	Basic	2,757	89	97.4%							64.2	0.1	12.8	0.6	B
17 I-80 EB - Eureka Rd On-ramp	Merge	2,752	94	97.2%	706	45	103.8%				62.7	0.5	14.5	0.5	B
18 I-80 EB - Eureka Rd On-ramp to SR-65 On-ramp	Basic	3,455	100	98.4%							63.9	0.1	15.9	0.5	B
19 I-80 EB - SR-65 On-ramp	Merge	3,453	98	98.4%	2,674	80	99.4%				59.4	0.7	28.1	0.4	D
20 I-80 EB - SR-65 to Rocklin Rd	Basic	6,128	126	98.8%							63.0	0.3	25.8	0.3	C
22 I-80 EB - Rocklin Rd Off-ramp	Diverge	6,110	107	98.6%				1,672	78	98.9%	63.5	0.2	25.4	0.5	C
23 I-80 EB - Rocklin Rd Off to On-ramp	Basic	4,432	126	98.3%							63.6	0.3	22.1	0.7	C
24 I-80 EB - Rocklin Rd On-ramp	Merge	4,430	122	98.2%	264	27	101.7%				60.0	0.8	23.8	0.9	C
25 I-80 EB - Rocklin Rd to Sierra College Blvd	Basic	4,690	121	98.3%							63.3	0.2	23.6	0.7	C
26 I-80 EB - Sierra College Blvd Off-ramp	Diverge	4,688	121	98.3%				557	46	88.4%	62.8	0.5	24.5	0.9	C
27 I-80 EB - Sierra College Blvd Off to On-ramp	Basic	4,128	109	99.7%							63.2	0.3	21.5	0.7	C
28 I-80 EB - Sierra College Blvd SB On-ramp	Merge	4,126	106	99.7%	324	8	95.1%				60.8	0.4	22.3	0.6	C
29 I-80 EB - Sierra College Blvd NB On-ramp	Merge	4,450	106	99.3%	881	21	102.5%				60.1	0.4	26.3	0.7	C
38 I-80 WB - Sierra College Blvd Off-ramp	Diverge	4,081	18	106.0%				758	51	103.9%	60.2	0.6	20.2	0.4	C
39 I-80 WB - Sierra College Blvd Off to On-ramp	Basic	3,318	55	106.3%							63.6	0.3	17.7	0.4	B
40 I-80 WB - Sierra College Blvd NB On-ramp	Merge	3,319	57	106.4%	407	11	101.6%				62.3	0.4	18.0	0.6	B
41 I-80 WB - Sierra College Blvd SB On-ramp	Merge	3,725	62	105.8%	433	9	100.8%				62.0	0.6	20.6	0.6	C
42 I-80 WB - Sierra College Blvd to Rocklin Rd	Basic	4,155	67	105.2%							63.4	0.2	21.2	0.5	C
43 I-80 WB - Rocklin Rd Off-ramp	Diverge	4,156	66	105.2%				302	29	108.0%	63.0	0.4	22.3	0.7	C
44 I-80 WB - Rocklin Rd Off to On-ramp	Basic	3,851	76	104.9%							63.3	0.2	19.7	0.4	C
45 I-80 WB - Rocklin Rd On-ramp	Merge	3,850	77	104.9%	1,629	45	103.1%				58.5	1.3	27.8	1.1	C
46 I-80 WB - Rocklin Rd to HOV Lane Start	Basic	5,475	79	104.3%							60.4	1.0	29.7	1.0	D
47 I-80 WB - HOV Lane Start to SR-65	Basic	5,469	104	104.2%							61.8	0.5	22.4	0.4	C
48 I-80 WB - SR-65 Off-ramp	Diverge	5,466	107	104.1%				2,324	77	102.8%	63.8	0.2	20.5	0.2	C
49 I-80 WB - SR-65 Off to On-ramp	Basic	3,137	83	104.9%							63.9	0.1	16.5	0.5	B
60 I-80 WB - SR-65 to Atlantic St	Weave	3,140	83	105.0%	5,072	116	99.8%	536	53	101.1%	59.5	0.4	23.0	0.5	C
62 I-80 WB - Atlantic St EB Off-ramp	Diverge	7,774	185	103.1%				1,277	77	100.5%	61.0	1.5	26.9	1.0	C
63 I-80 WB - Atlantic St EB Off to On-ramp	Basic	6,493	164	103.6%							63.1	0.2	24.2	0.8	C
64 I-80 WB - Atlantic St On-ramp	Merge	6,495	163	103.6%	1,232	60	99.4%				59.0	1.4	37.0	1.1	E
65 I-80 WB - Douglas Blvd Off-ramp	Diverge	7,726	184	102.9%				1,216	75	101.3%	61.8	0.3	33.7	1.1	D
66 I-80 WB - Douglas Blvd Off to On-ramp	Basic	6,508	143	103.1%							63.4	0.1	24.1	0.7	C
67 I-80 WB - Douglas Blvd WB On-ramp	Merge	6,507	135	103.1%	1,129	90	83.6%				58.0	1.8	29.1	1.0	D
68 I-80 WB - Douglas Blvd EB On-ramp	Merge	7,637	154	99.7%	742	29	101.7%				60.3	0.8	33.5	0.6	D
69 I-80 WB - Douglas Blvd to Riverside Ave	Basic	8,379	128	99.9%							61.3	0.6	32.3	0.6	D
70 I-80 WB - Riverside Ave Off-ramp	Diverge	8,378	145	99.9%				1,299	61	103.1%	62.5	0.2	33.5	0.7	D
71 I-80 WB - Riverside Ave Off to On-ramp	Basic	7,079	144	99.3%							63.1	0.3	26.2	0.9	D
72 I-80 WB - Riverside Ave NB On-ramp	Merge	7,077	141	99.2%	200	1	100.0%				63.4	0.1	23.9	0.9	C
73 I-80 WB - Riverside Ave SB On-ramp	Merge	7,272	131	99.2%	524	13	98.8%				60.9	1.1	27.6	1.3	C
74 I-80 WB - Riverside Ave to Antelope Rd	Basic	7,790	146	99.1%							61.9	0.5	28.7	0.9	D
75 I-80 WB - Antelope Rd Off-ramp	Diverge	7,787	156	99.1%				1,154	60	100.4%	62.3	1.2	30.9	1.1	D
76 I-80 WB - Antelope Rd Off to On-ramp	Basic	6,633	146	98.9%							63.0	0.6	24.1	0.9	C
77 I-80 WB - Antelope Rd WB On-ramp	Merge	6,636	147	98.9%	342	3	97.6%				60.4	0.9	24.1	0.8	C
78 I-80 WB - Antelope Rd to Truck Scales	Weave	6,978	152	98.8%	528	17	99.5%	76	20	69.5%	62.0	0.4	25.8	0.7	C
79 I-80 WB - Truck Scales Off to On-ramp	Basic	7,429	151	99.3%							62.8	0.1	27.0	0.8	D
80 I-80 WB - Truck Scales On-ramp	Merge	7,425	158	99.3%	76	17	69.5%				62.5	0.2	27.5	0.8	C
81 I-80 WB - Truck Scales to Elkhorn Blvd	Basic	7,506	153	98.9%							61.7	0.4	28.7	0.8	D
82 I-80 WB - Elkhorn Blvd Off-ramp	Diverge	7,501	161	98.8%				1,208	62	96.6%	61.8	0.7	28.0	0.7	D
83 I-80 WB - Elkhorn Blvd Off to On-ramp	Basic	6,294	143	99.3%							62.9	0.4	23.1	0.7	C
84 I-80 WB - Elkhorn Blvd WB On-ramp	Merge	6,294	145	99.3%	898	5	99.8%				55.6	1.3	27.5	1.3	C
85 I-80 WB - Elkhorn Blvd EB On-ramp	Merge	7,200	152	99.4%	582	10	100.3%				61.0	1.4	29.1	0.9	D

Notes: Average density reported for the analysis area only: for example, within the ramp influence area and not including the HOV lane.
Mainline volume is the upstream served volume for all lanes.

Location	Facility Type	Mainline Volume (vph)			On-ramp Volume (vph)			Off-ramp Volume (vph)			Speed (mph)		Density (vplpm)		LOS
		Avg.	St. Dev.	%	Avg.	St. Dev.	%	Avg.	St. Dev.	%	Avg.	St. Dev.	Avg.	St. Dev.	
100 SR-65 NB - EB I-80 Connector	Basic	3,651	93	100.9%							61.7	0.7	32.3	0.9	D
101 SR-65 NB - Eureka Rd On-ramp	Merge	3,653	93	100.9%	1,361	65	99.4%				48.3	0.2	36.6	1.0	E
102 SR-65 NB - WB I-80 Connector	Basic	2,323	80	102.8%							52.2	0.4	23.5	0.6	C
103 SR-65 NB - I-80 to Stanford Ranch Rd	Weave	5,016	124	100.5%	3,389	93	100.6%	1,441	72	99.4%	55.8	1.5	32.9	1.4	D
106 SR-65 NB - Stanford Ranch Rd Off to On-ramp	Basic	6,950	148	100.6%							62.4	0.2	33.0	0.8	D
107 SR-65 NB - Stanford Ranch Rd to Pleasant Grove Blvd	Weave	6,950	148	100.6%	1,391	67	100.1%	1,692	86	100.7%	60.8	0.5	32.8	0.7	D
110 SR-65 NB - Pleasant Grove Blvd Off to On-ramp	Basic	6,642	139	100.3%							59.6	1.0	32.6	0.7	D
111 SR-65 NB - Pleasant Grove Blvd On-ramp	Merge	6,646	139	100.4%	539	30	98.1%				60.8	0.6	32.9	0.7	D
112 SR-65 NB - Blue Oaks Blvd Off-ramp	Diverge	7,189	145	100.3%				2,396	85	99.4%	62.5	0.2	31.0	0.5	D
114 SR-65 NB - Blue Oaks Blvd Off to On-ramp	Basic	4,787	132	100.6%							63.0	0.2	26.2	0.8	D
115 SR-65 NB - Blue Oaks Blvd On-ramp	Merge	4,785	132	100.5%	1,092	78	101.1%				61.4	0.2	24.8	0.4	C
116 SR-65 NB - Blue Oaks Blvd to Sunset Blvd	Basic	5,875	136	100.6%							62.4	0.2	25.9	0.6	C
118 SR-65 NB - Sunset Blvd Off-ramp	Diverge	5,873	136	100.6%				1,277	66	101.3%	63.1	0.1	25.9	0.5	C
119 SR-65 NB - Sunset Blvd Off to On-ramp	Basic	4,591	128	100.2%							63.0	0.2	24.7	0.6	C
120 SR-65 NB - Sunset Blvd EB On-ramp	Merge	4,587	126	100.2%	448	31	99.6%				60.8	1.8	27.2	1.1	C
121 SR-65 NB - Sunset Blvd to Whitney Ranch Pkwy	Weave	5,034	121	100.1%	547	33	105.2%	1,197	62	102.3%	61.9	0.4	26.1	0.7	C
124 SR-65 NB - Whitney Ranch Pkwy Off to On-ramp	Basic	4,378	119	99.9%							63.0	0.2	24.8	0.6	C
125 SR-65 NB - Whitney Ranch Pkwy EB On-ramp	Merge	4,374	120	99.9%	432	37	100.5%				61.9	1.0	26.7	0.9	C
126 SR-65 NB - Whitney Ranch Pkwy to Twelve Bridges Dr	Weave	4,798	119	99.8%	702	41	103.3%	1,084	52	101.3%	62.3	0.5	24.4	0.6	C
129 SR-65 NB - Twelve Bridges Dr Off to On-ramp	Basic	4,400	123	99.5%							62.9	0.2	24.9	0.7	C
130 SR-65 NB - Twelve Bridges Dr to Lincoln Blvd	Weave	4,395	125	99.4%	992	53	97.2%	1,651	85	118.8%	62.3	0.4	23.6	0.7	C
133 SR-65 NB - Lincoln Blvd to Ferrari Ranch Rd	Basic	3,735	108	92.2%							61.9	0.5	27.7	0.8	D
134 SR-65 NB - Ferrari Ranch Rd Off-ramp	Diverge	3,734	106	92.2%				2,026	83	99.3%	62.9	0.2	23.4	0.8	C
135 SR-65 NB - Ferrari Ranch Rd Off to On-ramp	Basic	1,706	68	84.9%							64.1	0.1	14.2	0.8	B
136 SR-65 NB - Ferrari Ranch Rd On-ramp	Merge	1,703	68	84.7%	212	10	100.9%				62.1	0.3	14.9	0.8	B
150 SR-65 SB - Ferrari Ranch Rd Off-ramp	Diverge	2,055	49	100.7%				267	24	99.0%	63.6	0.2	18.3	0.3	B
151 SR-65 SB - Ferrari Ranch Rd Off to On-ramp	Basic	1,787	64	101.0%							63.9	0.2	15.6	0.5	B
152 SR-65 SB - Ferrari Ranch Rd WB On-ramp	Merge	1,789	62	101.1%	700	21	98.5%				61.8	0.4	15.4	0.4	B
153 SR-65 SB - Ferrari Ranch Rd EB On-ramp	Merge	2,489	66	100.4%	679	18	99.8%				61.5	0.2	16.2	0.2	B
154 SR-65 SB - Ferrari Ranch Rd to Lincoln Blvd	Basic	3,162	71	100.1%							63.9	0.2	17.9	0.3	B
156 SR-65 SB - Lincoln Blvd to Twelve Bridges Dr	Weave	3,163	73	100.1%	780	50	100.0%	872	51	100.2%	62.4	0.4	17.0	0.3	B
159 SR-65 SB - Twelve Bridges Dr Off to On-ramp	Basic	3,068	89	99.9%							63.8	0.2	16.8	0.5	B
160 SR-65 SB - Twelve Bridges Dr to Placer Pkwy	Weave	3,070	85	100.0%	874	29	92.0%	1,077	65	97.9%	62.9	0.1	17.3	0.3	B
163 SR-65 SB - Placer Pkwy Off to On-ramp	Basic	2,870	95	98.3%							63.8	0.2	15.5	0.6	B
164 SR-65 SB - Placer Pkwy WB On-ramp	Merge	2,871	95	98.3%	409	31	102.2%				62.6	0.3	18.7	0.8	B
165 SR-65 SB - Placer Pkwy to Sunset Blvd	Weave	3,283	101	98.9%	758	53	101.0%	614	47	97.4%	63.0	0.2	18.4	0.7	B
168 SR-65 SB - Sunset Blvd Off to On-ramp	Basic	3,423	99	99.5%							63.7	0.1	18.6	0.8	C
169 SR-65 SB - Sunset Blvd WB On-ramp	Merge	3,426	100	99.6%	1,011	42	106.5%				61.2	0.5	23.9	0.6	C
170 SR-65 SB - Sunset Blvd to Blue Oaks Blvd	Weave	4,435	106	101.0%	1,136	43	102.4%	873	56	98.1%	62.7	0.3	24.5	0.5	C
172 SR-65 SB - Blue Oaks Blvd Off- Ramp to HOV Lane Start	Basic	4,695	106	101.8%							63.0	0.2	26.0	0.5	C
173 SR-65 SB - HOV Lane Start to Blue Oaks Blvd WB On-ramp	Basic	4,696	108	101.9%							63.0	0.1	25.8	0.5	C
174 SR-65 SB - Blue Oaks Blvd WB On-ramp	Merge	4,697	109	101.9%	383	51	100.8%				61.6	0.2	26.9	0.6	C
175 SR-65 SB - Blue Oaks Blvd to Pleasant Grove Blvd	Weave	5,075	108	101.7%	1,401	43	99.4%	651	41	95.7%	61.5	0.8	27.6	0.5	C
178 SR-65 SB - Pleasant Grove Blvd Off to On-ramp	Basic	5,826	130	101.8%							62.7	0.2	30.5	0.7	D
179 SR-65 SB - Pleasant Grove Blvd WB On-ramp	Merge	5,826	126	101.9%	581	37	100.2%				61.4	0.4	29.9	0.7	D
180 SR-65 SB - Pleasant Grove Blvd EB On-ramp	Merge	6,410	129	101.7%	1,187	47	99.7%				57.5	3.0	29.7	1.8	D
181 SR-65 SB - Pleasant Grove Blvd to Galleria Blvd	Basic	7,594	138	101.4%							59.2	8.0	33.9	6.7	D
182 SR-65 SB - Galleria Blvd Off-ramp	Diverge	7,592	143	101.4%				1,630	84	100.6%	59.0	10.8	35.1	13.8	E
183 SR-65 SB - Galleria Blvd Off to On-ramp	Basic	5,955	140	101.4%							60.3	2.2	34.6	1.2	D
184 SR-65 SB - Galleria Blvd to I-80	Weave	5,954	144	101.4%	1,204	55	101.1%	4,469	111	102.3%	61.5	0.6	28.0	1.1	D
187 SR-65 SB - EB I-80 Connector	Basic	2,685	87	99.8%							47.6	1.7	39.1	2.6	E
188 SR-65 SB - WB I-80 Connector	Basic	3,804	99	99.8%							54.3	0.4	24.3	0.6	C

Notes: Average density reported for the analysis area only: for example, within the ramp influence area and not including the HOV lane.
Mainline volume is the upstream served volume for all lanes.

VISSIM Post-Processor
Average Results from 10 Runs
Intersection Volume and Delay

SR 65 Widening
Design Year - HOV Lane Alternative
AM Peak Hour

	Intersection	Control	Volume (vph)		Percent Served	Delay (sec/veh)		Level of Service
			Demand	Served		Average	Std. Dev.	
1	Lincoln Blvd/Sterling Pkwy	Signal	3,125	3,430	109.8%	14.7	1.3	B
2	SR-65 SB Ramps/Twelve Bridges Dr	Signal	2,655	2,880	108.5%	14.8	0.6	B
3	SR-65 NB Ramps/Twelve Bridges Dr	Signal	2,655	2,823	106.3%	21.9	2.5	C
4	SR-65 SB Ramps/Sunset Blvd	Signal	3,735	4,073	109.1%	32.4	10.6	C
5	SR-65 NB Ramps/Sunset Blvd	Signal	4,055	4,439	109.5%	12.3	1.0	B
6	SR-65 SB Ramps-Washington Blvd/Blue Oaks Blvd	Signal	5,560	5,816	104.6%	56.5	7.9	E
7	SR-65 NB Ramps/Blue Oaks Blvd	Signal	3,535	3,778	106.9%	16.9	0.8	B
8	SR-65 SB Ramps/Pleasant Grove Blvd	Signal	4,585	4,715	102.8%	8.6	0.9	A
9	SR-65 NB Ramps/Pleasant Grove Blvd	Signal	3,550	3,572	100.6%	15.7	0.9	B
10	Stanford Ranch Rd/Five Star Blvd	Signal	2,755	2,863	103.9%	27.2	2.8	C
11	SR-65 NB Ramps/Stanford Ranch Rd	Signal	3,115	3,243	104.1%	11.0	0.6	B
12	SR-65 SB Ramps/Galleria Blvd	Signal	3,490	3,596	103.0%	18.6	3.5	B
13	Galleria Blvd/Antelope Creek Dr	Signal	2,701	2,794	103.4%	9.6	1.6	A
14	Galleria Blvd/Roseville Pkwy	Signal	5,336	5,735	107.5%	46.9	5.8	D
15	Creekside Ridge Dr/Roseville Pkwy	Signal	3,470	3,685	106.2%	8.4	2.7	A
16	Taylor Rd/East Roseville Pkwy	Signal	4,880	5,261	107.8%	70.0	11.6	E
17	North Sunrise Ave/East Roseville Pkwy	Signal	4,810	5,175	107.6%	32.7	3.6	C
18	Wills Rd/Atlantic St	Signal	2,295	2,473	107.8%	22.7	2.6	C
19	I-80 WB Ramps/Atlantic St	Signal	3,830	4,073	106.3%	10.9	2.1	B
20	Taylor Rd-I-80 EB Ramps/Eureka Rd	Signal	5,400	5,658	104.8%	30.2	2.5	C
21	North Sunrise Ave/Eureka Rd	Signal	5,110	5,380	105.3%	40.6	3.9	D
22	Harding Blvd/Wills Rd	Signal	2,145	2,294	106.9%	16.1	2.2	B
23	Harding Blvd/Douglas Blvd	Signal	2,710	2,954	109.0%	26.4	3.5	C
24	I-80 WB Ramps/Douglas Blvd	Signal	3,935	4,177	106.2%	20.9	5.8	C

Network Summary	
Total Demand Volume (veh/hr)	89,437
Total Volume Served (veh/hr)	94,888
Percent Served	106.1%

- Notes: 1. Volume is measured for the entire peak hour.
2. Delay is measured for the peak 15 minutes in the peak hour.

**VISSIM Post-Processor
Average Results from 10 Runs
Intersection Volume and Delay**

**SR 65 Widening
Design Year - HOV Lane Alternative
AM Peak Hour**

	Intersection	Control	Volume (vph)		Percent Served	Delay (sec/veh)		Level of Service
			Demand	Served		Average	Std. Dev.	
25	I-80 EB Ramps/Douglas Blvd	Signal	4,239	4,533	106.9%	27.6	13.6	C
26	North Sunrise Ave/Douglas Blvd	Signal	4,580	4,833	105.5%	53.5	21.2	D
27	Pacific St/Woodside Dr	Signal	2,283	2,448	107.3%	7.6	1.1	A
28	Pacific St/Sunset Blvd	Signal	3,514	3,654	104.0%	25.8	1.5	C
29	Granite Dr/Rocklin Rd	Signal	2,974	2,986	100.4%	28.5	2.4	C
30	I-80 WB Ramps/Rocklin Rd	Signal	3,078	3,107	101.0%	22.6	1.2	C
31	I-80 EB Ramps/Rocklin Rd	Signal	3,240	3,415	105.4%	29.8	16.0	C
32	Aguilar Rd/Rocklin Rd	Signal	2,315	2,513	108.6%	9.8	0.8	A
33	Lincoln Blvd/SR-65 NB Off-Ramp	Signal	2,761	3,179	115.1%	9.6	0.8	A
34	Lincoln Blvd/SR-65 SB On-Ramp	Signal	2,030	2,302	113.4%	21.8	3.5	C
35	SR-65 SB Ramps/Placer Pkwy	Signal	3,851	4,401	114.3%	24.1	7.0	C
36	SR-65 NB Ramps/Whitney Ranch Pkwy	Signal	3,586	3,946	110.0%	16.0	5.7	B
40	Galleria Blvd/Berry St	Signal	2,005	2,139	106.7%	10.2	1.7	B

Network Summary	
Total Demand Volume (veh/hr)	40,455
Total Volume Served (veh/hr)	43,456
Percent Served	107.4%

- Notes: 1. Volume is measured for the entire peak hour.
2. Delay is measured for the peak 15 minutes in the peak hour.

VISSIM Post-Processor
Average Results from 10 Runs
Intersection Volume and Delay

SR 65 Widening
Design Year - HOV Lane Alternative
PM Peak Hour

	Intersection	Control	Volume (vph)		Percent Served	Delay (sec/veh)		Level of Service
			Demand	Served		Average	Std. Dev.	
1	Lincoln Blvd/Sterling Pkwy	Signal	3,670	3,666	99.9%	22.7	1.2	C
2	SR-65 SB Ramps/Twelve Bridges Dr	Signal	2,655	2,588	97.5%	26.8	13.3	C
3	SR-65 NB Ramps/Twelve Bridges Dr	Signal	2,870	2,839	98.9%	20.2	2.0	C
4	SR-65 SB Ramps/Sunset Blvd	Signal	4,950	5,092	102.9%	9.9	0.8	A
5	SR-65 NB Ramps/Sunset Blvd	Signal	4,750	4,919	103.6%	15.5	3.6	B
6	SR-65 SB Ramps-Washington Blvd/Blue Oaks Blvd	Signal	7,155	7,248	101.3%	140.1	24.3	F
7	SR-65 NB Ramps/Blue Oaks Blvd	Signal	4,665	4,794	102.8%	45.0	36.3	D
8	SR-65 SB Ramps/Pleasant Grove Blvd	Signal	6,285	6,291	100.1%	9.2	0.7	A
9	SR-65 NB Ramps/Pleasant Grove Blvd	Signal	5,450	5,470	100.4%	14.8	0.9	B
10	Stanford Ranch Rd/Five Star Blvd	Signal	4,390	4,355	99.2%	82.0	24.7	F
11	SR-65 NB Ramps/Stanford Ranch Rd	Signal	5,570	5,566	99.9%	36.4	41.0	D
12	SR-65 SB Ramps/Galleria Blvd	Signal	5,925	5,963	100.6%	25.1	22.1	C
13	Galleria Blvd/Antelope Creek Dr	Signal	4,490	4,468	99.5%	28.2	2.3	C
14	Galleria Blvd/Roseville Pkwy	Signal	8,005	7,644	95.5%	93.3	18.0	F
15	Creekside Ridge Dr/Roseville Pkwy	Signal	4,655	4,407	94.7%	50.4	7.5	D
16	Taylor Rd/East Roseville Pkwy	Signal	6,710	6,460	96.3%	51.5	6.5	D
17	North Sunrise Ave/East Roseville Pkwy	Signal	6,325	6,361	100.6%	70.3	69.5	E
18	Wills Rd/Atlantic St	Signal	3,210	3,303	102.9%	24.1	2.6	C
19	I-80 WB Ramps/Atlantic St	Signal	4,860	4,942	101.7%	13.3	2.1	B
20	Taylor Rd-I-80 EB Ramps/Eureka Rd	Signal	6,575	6,688	101.7%	75.0	15.4	E
21	North Sunrise Ave/Eureka Rd	Signal	6,790	7,077	104.2%	93.8	25.7	F
22	Harding Blvd/Wills Rd	Signal	2,915	2,991	102.6%	16.5	1.5	B
23	Harding Blvd/Douglas Blvd	Signal	3,910	3,831	98.0%	91.1	12.9	F
24	I-80 WB Ramps/Douglas Blvd	Signal	4,705	4,429	94.1%	27.5	19.9	C

Network Summary	
Total Demand Volume (veh/hr)	121,485
Total Volume Served (veh/hr)	121,392
Percent Served	99.9%

- Notes: 1. Volume is measured for the entire peak hour.
2. Delay is measured for the peak 15 minutes in the peak hour.

VISSIM Post-Processor
Average Results from 10 Runs
Intersection Volume and Delay

SR 65 Widening
Design Year - HOV Lane Alternative
PM Peak Hour

	Intersection	Control	Volume (vph)		Percent Served	Delay (sec/veh)		Level of Service
			Demand	Served		Average	Std. Dev.	
25	I-80 EB Ramps/Douglas Blvd	Signal	5,445	4,985	91.6%	37.3	29.2	D
26	North Sunrise Ave/Douglas Blvd	Signal	6,275	5,566	88.7%	254.2	27.1	F
27	Pacific St/Woodside Dr	Signal	3,350	3,349	100.0%	9.8	1.7	A
28	Pacific St/Sunset Blvd	Signal	5,105	5,108	100.1%	32.5	1.4	C
29	Granite Dr/Rocklin Rd	Signal	3,990	4,126	103.4%	94.8	27.0	F
30	I-80 WB Ramps/Rocklin Rd	Signal	3,850	3,949	102.6%	67.5	15.4	E
31	I-80 EB Ramps/Rocklin Rd	Signal	3,825	3,874	101.3%	20.6	2.1	C
32	Aguilar Rd/Rocklin Rd	Signal	3,010	3,051	101.3%	31.5	11.7	C
33	Lincoln Blvd/SR-65 NB Off-Ramp	Signal	3,240	3,254	100.4%	12.2	1.2	B
34	Lincoln Blvd/SR-65 SB On-Ramp	Signal	1,600	1,606	100.4%	17.0	1.1	B
35	SR-65 SB Ramps/Placer Pkwy	Signal	4,860	4,933	101.5%	18.5	1.8	B
36	SR-65 NB Ramps/Whitney Ranch Pkwy	Signal	4,630	4,711	101.7%	21.8	2.2	C
40	Galleria Blvd/Berry St	Signal	2,930	2,960	101.0%	12.0	1.2	B

Network Summary	
Total Demand Volume (veh/hr)	52,110
Total Volume Served (veh/hr)	51,472
Percent Served	98.8%

Notes: 1. Volume is measured for the entire peak hour.
2. Delay is measured for the peak 15 minutes in the peak hour.

Intersection 2

SR-65 SB Ramps/Twelve Bridges Dr

Signalized

Direction	Movement	Storage (ft)	Average Queue (ft)		Maximum Queue (ft)		Exceeds Storage?
			Average	Std. Dev.	Average	Std. Dev.	
SB	Left Turn	440	41	13	230	39	NO
	Through						
	Right Turn	1,500	36	14	226	39	NO

Intersection 3

SR-65 NB Ramps/Twelve Bridges Dr

Signalized

Direction	Movement	Storage (ft)	Average Queue (ft)		Maximum Queue (ft)		Exceeds Storage?
			Average	Std. Dev.	Average	Std. Dev.	
NB	Left Turn	700	25	23	177	35	NO
	Through						
	Right Turn	1,500	25	23	177	35	NO

Intersection 4

SR-65 SB Ramps/Sunset Blvd

Signalized

Direction	Movement	Storage (ft)	Average Queue (ft)		Maximum Queue (ft)		Exceeds Storage?
			Average	Std. Dev.	Average	Std. Dev.	
SB	Left Turn	360	67	6	260	38	NO
	Through						
	Right Turn	1,330	69	6	263	38	NO

Intersection 5

SR-65 NB Ramps/Sunset Blvd

Signalized

Direction	Movement	Storage (ft)	Average Queue (ft)		Maximum Queue (ft)		Exceeds Storage?
			Average	Std. Dev.	Average	Std. Dev.	
NB	Left Turn	1,400	52	3	224	45	NO
	Through						
	Right Turn	1,400	27	3	172	39	NO

Note: The "Average Queue" is calculated on a time-step basis so that queues when the approach is green (zero length) are included in the average.

Intersection 6

SR-65 SB Ramps-Washington Blvd/Blue Oaks Blvd

Signalized

Direction	Movement	Storage (ft)	Average Queue (ft)		Maximum Queue (ft)		Exceeds Storage?
			Average	Std. Dev.	Average	Std. Dev.	
SB	Left Turn	200	39	9	199	113	NO
	Through	2,260	219	150	1,420	333	NO
	Right Turn	200	79	117	1,231	421	MAX

Intersection 7

SR-65 NB Ramps/Blue Oaks Blvd

Signalized

Direction	Movement	Storage (ft)	Average Queue (ft)		Maximum Queue (ft)		Exceeds Storage?
			Average	Std. Dev.	Average	Std. Dev.	
NB	Left Turn	400	50	22	318	37	NO
	Through						
	Right Turn	1,100	49	22	317	37	NO

Intersection 8

SR-65 SB Ramps/Pleasant Grove Blvd

Signalized

Direction	Movement	Storage (ft)	Average Queue (ft)		Maximum Queue (ft)		Exceeds Storage?
			Average	Std. Dev.	Average	Std. Dev.	
SB	Left Turn	430	33	4	190	31	NO
	Through						
	Right Turn	1,130	36	4	192	31	NO

Intersection 9

SR-65 NB Ramps/Pleasant Grove Blvd

Signalized

Direction	Movement	Storage (ft)	Average Queue (ft)		Maximum Queue (ft)		Exceeds Storage?
			Average	Std. Dev.	Average	Std. Dev.	
NB	Left Turn	1,420	47	8	196	23	NO
	Through						
	Right Turn	1,420	46	8	196	23	NO

Note: The "Average Queue" is calculated on a time-step basis so that queues when the approach is green (zero length) are included in the average.

VISSIM Post-Processor
 Average Results from 10 Runs
 Queue Length

SR 65 Widening
 Design Year - HOV Lane Alternative
 AM Peak Hour

Intersection 11

SR-65 NB Ramps/Stanford Ranch Rd

Signalized

Direction	Movement	Storage (ft)	Average Queue (ft)		Maximum Queue (ft)		Exceeds Storage?
			Average	Std. Dev.	Average	Std. Dev.	
EB	Left Turn						
	Through						
	Right Turn	1,800	0	0	7	15	NO
WB	Left Turn						
	Through						
	Right Turn	1,170	31	3	176	20	NO

Intersection 12

SR-65 SB Ramps/Galleria Blvd

Signalized

Direction	Movement	Storage (ft)	Average Queue (ft)		Maximum Queue (ft)		Exceeds Storage?
			Average	Std. Dev.	Average	Std. Dev.	
EB	Left Turn						
	Through						
	Right Turn	1,130	66	5	362	72	NO
WB	Left Turn						
	Through						
	Right Turn	1,780	0	0	43	28	NO

Intersection 19

I-80 WB Ramps/Atlantic St

Signalized

Direction	Movement	Storage (ft)	Average Queue (ft)		Maximum Queue (ft)		Exceeds Storage?
			Average	Std. Dev.	Average	Std. Dev.	
NB	Left Turn						
	Through						
	Right Turn	1,150	0	0	40	128	NO
SB	Left Turn						
	Through						
	Right Turn	1,430	0	0	12	21	NO

Note: The "Average Queue" is calculated on a time-step basis so that queues when the approach is green (zero length) are included in the average.

Intersection 20

Taylor Rd-I-80 EB Ramps/Eureka Rd

Signalized

Direction	Movement	Storage (ft)	Average Queue (ft)		Maximum Queue (ft)		Exceeds Storage?
			Average	Std. Dev.	Average	Std. Dev.	
NB	Left Turn	180	137	71	693	576	MAX
	Through	1,700	104	44	610	489	NO
	Right Turn	1,700	58	68	616	763	NO
SB	Left Turn	550	31	5	103	27	NO
	Through						
	Right Turn	550	34	4	176	57	NO
EB	Left Turn	1,120	36	7	132	18	NO
	Through	1,120	110	35	722	62	NO
	Right Turn	810	13	11	320	52	NO
WB	Left Turn						
	Through	1,370	90	25	587	72	NO
	Right Turn	280	1	0	38	25	NO

Intersection 24

I-80 WB Ramps/Douglas Blvd

Signalized

Direction	Movement	Storage (ft)	Average Queue (ft)		Maximum Queue (ft)		Exceeds Storage?
			Average	Std. Dev.	Average	Std. Dev.	
SB	Left Turn	1,530	80	80	392	89	NO
	Through	1,530	80	80	392	89	NO
	Right Turn	730	80	80	392	89	NO

Note: The "Average Queue" is calculated on a time-step basis so that queues when the approach is green (zero length) are included in the average.

VISSIM Post-Processor
 Average Results from 10 Runs
 Queue Length

SR 65 Widening
 Design Year - HOV Lane Alternative
 AM Peak Hour

Intersection 25

I-80 EB Ramps/Douglas Blvd

Signalized

Direction	Movement	Storage (ft)	Average Queue (ft)		Maximum Queue (ft)		Exceeds Storage?
			Average	Std. Dev.	Average	Std. Dev.	
NB	Left Turn						
	Through						
	Right Turn	1,400	0	0	48	114	NO
SB	Left Turn						
	Through						
	Right Turn	1,250	15	2	99	20	NO

Intersection 30

I-80 WB Ramps/Rocklin Rd

Signalized

Direction	Movement	Storage (ft)	Average Queue (ft)		Maximum Queue (ft)		Exceeds Storage?
			Average	Std. Dev.	Average	Std. Dev.	
SB	Left Turn	700	21	2	136	61	NO
	Through						
	Right Turn	1,230	29	4	156	61	NO

Intersection 31

I-80 EB Ramps/Rocklin Rd

Signalized

Direction	Movement	Storage (ft)	Average Queue (ft)		Maximum Queue (ft)		Exceeds Storage?
			Average	Std. Dev.	Average	Std. Dev.	
NB	Left Turn	1,080	59	5	286	47	NO
	Through						
	Right Turn	1,080	48	12	302	47	NO

Note: The "Average Queue" is calculated on a time-step basis so that queues when the approach is green (zero length) are included in the average.

Intersection 33

Lincoln Blvd/SR-65 NB Off-Ramp

Signalized

Direction	Movement	Storage (ft)	Average Queue (ft)		Maximum Queue (ft)		Exceeds Storage?
			Average	Std. Dev.	Average	Std. Dev.	
WB	Left Turn	1,940	0	0	0	0	NO
	Through						
	Right Turn	1,940	25	8	178	44	NO

Intersection 35

SR-65 SB Ramps/Placer Pkwy

Signalized

Direction	Movement	Storage (ft)	Average Queue (ft)		Maximum Queue (ft)		Exceeds Storage?
			Average	Std. Dev.	Average	Std. Dev.	
SB	Left Turn	1,650	172	150	971	253	NO
	Through						
	Right Turn	1,650	173	150	972	253	NO

Intersection 36

SR-65 NB Ramps/Whitney Ranch Pkwy

Signalized

Direction	Movement	Storage (ft)	Average Queue (ft)		Maximum Queue (ft)		Exceeds Storage?
			Average	Std. Dev.	Average	Std. Dev.	
NB	Left Turn	1,620	61	7	283	35	NO
	Through						
	Right Turn	1,620	61	7	283	35	NO

Note: The "Average Queue" is calculated on a time-step basis so that queues when the approach is green (zero length) are included in the average.

Intersection 2

SR-65 SB Ramps/Twelve Bridges Dr

Signalized

Direction	Movement	Storage (ft)	Average Queue (ft)		Maximum Queue (ft)		Exceeds Storage?
			Average	Std. Dev.	Average	Std. Dev.	
SB	Left Turn	440	52	5	211	33	NO
	Through						
	Right Turn	1,500	48	6	207	33	NO

Intersection 3

SR-65 NB Ramps/Twelve Bridges Dr

Signalized

Direction	Movement	Storage (ft)	Average Queue (ft)		Maximum Queue (ft)		Exceeds Storage?
			Average	Std. Dev.	Average	Std. Dev.	
NB	Left Turn	700	26	3	103	18	NO
	Through						
	Right Turn	1,500	26	3	103	18	NO

Intersection 4

SR-65 SB Ramps/Sunset Blvd

Signalized

Direction	Movement	Storage (ft)	Average Queue (ft)		Maximum Queue (ft)		Exceeds Storage?
			Average	Std. Dev.	Average	Std. Dev.	
SB	Left Turn	360	59	3	200	34	NO
	Through						
	Right Turn	1,330	61	3	202	34	NO

Intersection 5

SR-65 NB Ramps/Sunset Blvd

Signalized

Direction	Movement	Storage (ft)	Average Queue (ft)		Maximum Queue (ft)		Exceeds Storage?
			Average	Std. Dev.	Average	Std. Dev.	
NB	Left Turn	1,400	63	1	243	41	NO
	Through						
	Right Turn	1,400	16	4	139	67	NO

Note: The "Average Queue" is calculated on a time-step basis so that queues when the approach is green (zero length) are included in the average.

Intersection 6

SR-65 SB Ramps-Washington Blvd/Blue Oaks Blvd

Signalized

Direction	Movement	Storage (ft)	Average Queue (ft)		Maximum Queue (ft)		Exceeds Storage?
			Average	Std. Dev.	Average	Std. Dev.	
SB	Left Turn	200	99	37	496	401	MAX
	Through	2,260	145	86	880	313	NO
	Right Turn	200	28	37	600	313	MAX

Intersection 7

SR-65 NB Ramps/Blue Oaks Blvd

Signalized

Direction	Movement	Storage (ft)	Average Queue (ft)		Maximum Queue (ft)		Exceeds Storage?
			Average	Std. Dev.	Average	Std. Dev.	
NB	Left Turn	400	49	7	236	50	NO
	Through						
	Right Turn	1,100	49	7	236	50	NO

Intersection 8

SR-65 SB Ramps/Pleasant Grove Blvd

Signalized

Direction	Movement	Storage (ft)	Average Queue (ft)		Maximum Queue (ft)		Exceeds Storage?
			Average	Std. Dev.	Average	Std. Dev.	
SB	Left Turn	430	32	5	137	28	NO
	Through						
	Right Turn	1,130	35	5	139	28	NO

Intersection 9

SR-65 NB Ramps/Pleasant Grove Blvd

Signalized

Direction	Movement	Storage (ft)	Average Queue (ft)		Maximum Queue (ft)		Exceeds Storage?
			Average	Std. Dev.	Average	Std. Dev.	
NB	Left Turn	1,420	52	2	214	42	NO
	Through						
	Right Turn	1,420	52	2	214	42	NO

Note: The "Average Queue" is calculated on a time-step basis so that queues when the approach is green (zero length) are included in the average.

Intersection 11

SR-65 NB Ramps/Stanford Ranch Rd

Signalized

Direction	Movement	Storage (ft)	Average Queue (ft)		Maximum Queue (ft)		Exceeds Storage?
			Average	Std. Dev.	Average	Std. Dev.	
EB	Left Turn						
	Through						
	Right Turn	1,800	0	0	24	18	NO
WB	Left Turn						
	Through						
	Right Turn	1,170	145	85	471	487	NO

Intersection 12

SR-65 SB Ramps/Galleria Blvd

Signalized

Direction	Movement	Storage (ft)	Average Queue (ft)		Maximum Queue (ft)		Exceeds Storage?
			Average	Std. Dev.	Average	Std. Dev.	
EB	Left Turn						
	Through						
	Right Turn	1,130	80	4	386	87	NO
WB	Left Turn						
	Through						
	Right Turn	1,780	78	81	320	476	NO

Intersection 19

I-80 WB Ramps/Atlantic St

Signalized

Direction	Movement	Storage (ft)	Average Queue (ft)		Maximum Queue (ft)		Exceeds Storage?
			Average	Std. Dev.	Average	Std. Dev.	
NB	Left Turn						
	Through						
	Right Turn	1,150	5	5	227	392	NO
SB	Left Turn						
	Through						
	Right Turn	1,430	0	0	40	44	NO

Note: The "Average Queue" is calculated on a time-step basis so that queues when the approach is green (zero length) are included in the average.

VISSIM Post-Processor
 Average Results from 10 Runs
 Queue Length

SR 65 Widening
 Design Year - HOV Lane Alternative
 PM Peak Hour

Intersection 20

Taylor Rd-I-80 EB Ramps/Eureka Rd

Signalized

Direction	Movement	Storage (ft)	Average Queue (ft)		Maximum Queue (ft)		Exceeds Storage?
			Average	Std. Dev.	Average	Std. Dev.	
NB	Left Turn	180	80	4	339	146	MAX
	Through	1,700	27	9	158	43	NO
	Right Turn	1,700	1	1	71	156	NO
SB	Left Turn	550	31	13	123	17	NO
	Through						
	Right Turn	550	104	54	580	126	MAX
EB	Left Turn	1,120	56	8	198	48	NO
	Through	1,120	202	25	783	50	NO
	Right Turn	810	38	9	370	47	NO
WB	Left Turn						
	Through	1,370	654	190	1,456	119	MAX
	Right Turn	280	16	17	296	364	MAX

Intersection 24

I-80 WB Ramps/Douglas Blvd

Signalized

Direction	Movement	Storage (ft)	Average Queue (ft)		Maximum Queue (ft)		Exceeds Storage?
			Average	Std. Dev.	Average	Std. Dev.	
SB	Left Turn	1,530	158	166	509	416	NO
	Through	1,530	158	166	509	416	NO
	Right Turn	730	159	166	509	416	NO

Note: The "Average Queue" is calculated on a time-step basis so that queues when the approach is green (zero length) are included in the average.

VISSIM Post-Processor
 Average Results from 10 Runs
 Queue Length

SR 65 Widening
 Design Year - HOV Lane Alternative
 PM Peak Hour

Intersection 25

I-80 EB Ramps/Douglas Blvd

Signalized

Direction	Movement	Storage (ft)	Average Queue (ft)		Maximum Queue (ft)		Exceeds Storage?
			Average	Std. Dev.	Average	Std. Dev.	
NB	Left Turn						
	Through						
	Right Turn	1,400	176	269	1,128	737	NO
SB	Left Turn						
	Through						
	Right Turn	1,250	22	2	171	112	NO

Intersection 30

I-80 WB Ramps/Rocklin Rd

Signalized

Direction	Movement	Storage (ft)	Average Queue (ft)		Maximum Queue (ft)		Exceeds Storage?
			Average	Std. Dev.	Average	Std. Dev.	
SB	Left Turn	700	87	80	418	165	NO
	Through						
	Right Turn	1,230	101	82	437	165	NO

Intersection 31

I-80 EB Ramps/Rocklin Rd

Signalized

Direction	Movement	Storage (ft)	Average Queue (ft)		Maximum Queue (ft)		Exceeds Storage?
			Average	Std. Dev.	Average	Std. Dev.	
NB	Left Turn	1,080	76	6	300	66	NO
	Through						
	Right Turn	1,080	59	5	310	67	NO

Note: The "Average Queue" is calculated on a time-step basis so that queues when the approach is green (zero length) are included in the average.

Intersection 33

Lincoln Blvd/SR-65 NB Off-Ramp

Signalized

Direction	Movement	Storage (ft)	Average Queue (ft)		Maximum Queue (ft)		Exceeds Storage?
			Average	Std. Dev.	Average	Std. Dev.	
WB	Left Turn	1,940	0	0	0	0	NO
	Through						
	Right Turn	1,940	82	3	402	62	NO

Intersection 35

SR-65 SB Ramps/Placer Pkwy

Signalized

Direction	Movement	Storage (ft)	Average Queue (ft)		Maximum Queue (ft)		Exceeds Storage?
			Average	Std. Dev.	Average	Std. Dev.	
SB	Left Turn	1,650	82	9	373	70	NO
	Through						
	Right Turn	1,650	83	9	374	70	NO

Intersection 36

SR-65 NB Ramps/Whitney Ranch Pkwy

Signalized

Direction	Movement	Storage (ft)	Average Queue (ft)		Maximum Queue (ft)		Exceeds Storage?
			Average	Std. Dev.	Average	Std. Dev.	
NB	Left Turn	1,620	127	23	480	88	NO
	Through						
	Right Turn	1,620	127	23	480	88	NO

Note: The "Average Queue" is calculated on a time-step basis so that queues when the approach is green (zero length) are included in the average.

SR 65 Capacity and Operational Improvements

**Vissim Model Results – Design Year
Alternative 2 (General Purpose Lane)**

VISSIM Post-Processor
Average Values from 10 Runs
Network Statistics

SR 65 Widening
Design Year - GP Lane Alternative
AM Peak Period

Network Performance	Vehicle Types	Average	Std. Dev.
Number of Vehicles Served	All Vehicles	207,465	65
Travel Distance [mi]	All Vehicles	950,657	1,683
Travel Time [h]	All Vehicles	21,965	78.4
Average Speed [mph]	All Vehicles	43.3	0.1
Total Delay [h]	All Vehicles	5,623	69.4
Average Delay per Vehicle [s]	All Vehicles	95	1.2
VHD/VMT [min/mile]	All Vehicles	0.35	0.00
Number of Vehicles Served	HOV	34,600	49
Travel Distance [mi]	HOV	164,213	803
Travel Time [h]	HOV	3,575	17
Average Speed [mph]	HOV	45.9	0.1
Total Delay [h]	HOV	775	9
Average Delay per Vehicle [s]	HOV	79	1
VHD/VMT [min/mile]	HOV	0.28	0.00
Number of Vehicles Served	Truck	7,555	20
Travel Distance [mi]	Truck	43,490	383
Travel Time [h]	Truck	970	9
Average Speed [mph]	Truck	44.8	0
Total Delay [h]	Truck	231	5
Average Delay per Vehicle [s]	Truck	107	2
VHD/VMT [min/mile]	Truck	0.32	0.01

Performance Measure	Vehicle Types		
	HOV	Truck	All
Vehicles Served	34,600	7,560	207,470
Demand Volume	35,900	8,200	210,070
Percent Demand Served	96.4%	92.2%	98.8%
Vehicle Miles of Travel	164,210	43,490	950,660
Person Miles of Travel	344,850	45,660	1,133,470
Vehicle Hours of Travel	3,580	970	21,960
Vehicle Hours of Delay	780	230	5,620
VHD % of VHT	21.8%	23.7%	25.6%
Average Delay per Vehicle (min)	1.35	1.83	1.63
Person Hours of Delay	1,640	240	6,490
Average Travel Speed	45.9	44.8	43.3

VISSIM Post-Processor
Average Values from 10 Runs
Peak Hour Travel Time

SR 65 Widening
Design Year - GP Lane Alternative
AM Peak Period

Mode	Description	Distance (ft)	Volume (vehicles)		Travel Time (min.:sec.)		Speed (mph)
			Average	Std. Dev.	Average	Std. Dev.	Average
SOV	SR-65 at Blue Oaks to I-80 at Antelope	43,090	1,091	16	08:37	00:10	22.7
	I-80 at Auburn to SR-65 at Blue Oaks	32,847	1,867	16	06:25	00:02	23.3
	I-80: Sierra College to Antelope	45,844	1,213	14	08:25	00:05	24.7
	I-80: Auburn to Sierra College	36,738	799	12	06:39	00:02	25.1
	SR-65: I-80 to Sunset	43,099	1,343	23	04:13	00:01	46.4
	SR-65: Sunset to Ferrari Ranch	45,832	416	9	03:31	00:00	59.4
	SR-65: Ferrari Ranch to Sunset	36,734	1,362	12	03:37	00:01	46.3
	SR-65: Sunset to I-80	32,852	1,832	19	04:16	00:05	35.0
HOV	SR-65 at Blue Oaks to I-80 at Antelope	43,090	301	8	08:29	00:06	46.4
	I-80 at Auburn to SR-65 at Blue Oaks	32,847	295	8	06:16	00:02	59.4
	I-80: Sierra College to Antelope	45,844	412	7	08:19	00:02	46.3
	I-80: Auburn to Sierra College	36,738	159	5	06:33	00:02	35.0
	SR-65: I-80 to Sunset	43,099	94	4	04:11	00:02	23.1
	SR-65: Sunset to Ferrari Ranch	45,832	53	3	03:30	00:02	23.8
	SR-65: Ferrari Ranch to Sunset	36,734	241	7	03:36	00:01	25.1
	SR-65: Sunset to I-80	32,852	501	10	04:14	00:06	25.5

VISSIM Post-Processor
Average Values from 10 Runs
Network Statistics

SR 65 Widening
Design Year - General Purpose Lane Alternative
PM Peak Period

Network Performance	Vehicle Types	Average	Std. Dev.
Number of Vehicles Served	All Vehicles	300,817	277
Travel Distance [mi]	All Vehicles	1,166,400	1,721
Travel Time [h]	All Vehicles	30,922	354.6
Average Speed [mph]	All Vehicles	37.7	0.4
Total Delay [h]	All Vehicles	10,428	343.5
Average Delay per Vehicle [s]	All Vehicles	123	4.1
VHD/VMT [min/mile]	All Vehicles	0.54	0.02
Number of Vehicles Served	HOV	53,306	89
Travel Distance [mi]	HOV	212,655	607
Travel Time [h]	HOV	5,269	55
Average Speed [mph]	HOV	40.4	0.3
Total Delay [h]	HOV	1,558	49
Average Delay per Vehicle [s]	HOV	103	3
VHD/VMT [min/mile]	HOV	0.44	0.01
Number of Vehicles Served	Truck	8,051	23
Travel Distance [mi]	Truck	40,271	346
Travel Time [h]	Truck	988	16
Average Speed [mph]	Truck	40.8	0
Total Delay [h]	Truck	294	12
Average Delay per Vehicle [s]	Truck	129	5
VHD/VMT [min/mile]	Truck	0.44	0.02

Performance Measure	Vehicle Types		
	HOV	Truck	All
Vehicles Served	53,310	8,050	300,820
Demand Volume	54,550	8,640	301,760
Percent Demand Served	97.7%	93.2%	99.7%
Vehicle Miles of Travel	212,650	40,270	1,166,400
Person Miles of Travel	446,570	42,280	1,402,330
Vehicle Hours of Travel	5,270	990	30,920
Vehicle Hours of Delay	1,560	290	10,430
VHD % of VHT	29.6%	29.3%	33.7%
Average Delay per Vehicle (min)	1.76	2.16	2.08
Person Hours of Delay	3,280	300	12,160
Average Travel Speed	40.4	40.8	37.7

VISSIM Post-Processor
Average Values from 10 Runs
Peak Hour Travel Time

SR 65 Widening
Design Year - General Purpose Lane Alternative
PM Peak Period

Mode	Description	Distance (ft)	Volume (vehicles)		Travel Time (min.:sec.)		Speed (mph)
			Average	Std. Dev.	Average	Std. Dev.	Average
SOV	SR-65 at Blue Oaks to I-80 at Antelope	43,091	924	12	08:24	00:03	23.3
	I-80 at Auburn to SR-65 at Blue Oaks	32,846	1,706	14	06:32	00:05	22.9
	I-80: Sierra College to Antelope	45,844	632	9	08:22	00:02	24.9
	I-80: Auburn to Sierra College	36,738	906	16	06:44	00:05	24.8
	SR-65: I-80 to Sunset	43,100	2,080	21	04:19	00:02	45.4
	SR-65: Sunset to Ferrari Ranch	45,833	623	11	03:34	00:01	58.4
	SR-65: Ferrari Ranch to Sunset	36,734	941	11	03:31	00:00	47.6
	SR-65: Sunset to I-80	32,851	1,385	19	04:07	00:02	36.2
HOV	SR-65 at Blue Oaks to I-80 at Antelope	43,091	212	6	08:19	00:03	45.4
	I-80 at Auburn to SR-65 at Blue Oaks	32,846	596	9	06:20	00:02	58.4
	I-80: Sierra College to Antelope	45,844	201	6	08:15	00:02	47.6
	I-80: Auburn to Sierra College	36,738	315	8	06:38	00:02	36.2
	SR-65: I-80 to Sunset	43,100	89	4	04:17	00:02	23.6
	SR-65: Sunset to Ferrari Ranch	45,833	128	5	03:34	00:01	23.5
	SR-65: Ferrari Ranch to Sunset	36,734	187	5	03:31	00:01	25.2
	SR-65: Sunset to I-80	32,851	282	8	04:06	00:02	25.2

VISSIM Post-Processor
Average Results from 10 Runs
Freeway Operations Summary

SR 65 Widening
Design Year - GP Lane Alternative
AM Peak Hour

Location	Facility Type	Mainline Volume (vph)			On-ramp Volume (vph)			Off-ramp Volume (vph)			Speed (mph)		Density (vplpm)		LOS
		Avg.	St. Dev.	%	Avg.	St. Dev.	%	Avg.	St. Dev.	%	Avg.	St. Dev.	Avg.	St. Dev.	
1 I-80 EB - Auburn Blvd On-ramp	Merge	7,491	44	110.2%	1,242	18	109.9%				62.0	0.5	29.7	0.3	D
2 I-80 EB - Auburn Blvd to Douglas Blvd	Basic	8,726	89	110.0%							61.4	0.5	32.2	0.4	D
3 I-80 EB - Douglas Blvd EB Off-ramp	Diverge	8,714	117	109.9%				1,383	51	108.0%	61.0	2.9	28.8	1.8	D
4 I-80 EB - Douglas Blvd WB Off-ramp	Diverge	7,327	133	110.2%				355	27	110.9%	62.5	1.1	24.2	0.6	C
5 I-80 EB - Douglas Blvd Off to On-ramp	Basic	6,969	128	110.1%							63.0	0.3	24.9	0.3	C
6 I-80 EB - Douglas Blvd to Eureka Rd	Weave	6,968	127	110.1%	1,186	29	97.2%	1,764	71	104.4%	62.5	0.3	23.4	0.3	C
7 I-80 EB CD - Eureka Rd to Taylor Rd/SR-65	Weave	613	39	102.2%	1,268	65	105.7%	876	39	103.0%	61.6	1.2	14.8	0.7	B
8 I-80 EB - Eureka Rd to SR-65	Basic	6,388	105	109.0%							62.2	0.2	27.2	0.4	D
9 I-80 EB - HOV Connector Off-ramp	Diverge	6,386	109	109.0%				586	43	108.4%	60.2	0.7	27.2	0.6	C
10 I-80 EB - SR-65 Off-ramp	Diverge	5,804	98	109.1%				3,365	101	108.6%	63.3	0.4	22.2	0.3	C
11 I-80 EB - SR-65 Off-ramp to Eureka Rd On-ramp	Basic	2,440	65	109.9%							64.0	0.2	13.5	0.5	B
17 I-80 EB - Eureka Rd On-ramp	Merge	2,442	72	110.0%	578	29	103.2%				63.0	0.2	14.1	0.7	B
18 I-80 EB - Eureka Rd On-ramp to SR-65 On-ramp	Basic	3,021	84	108.7%							63.8	0.2	15.3	0.6	B
19 I-80 EB - SR-65 On-ramp	Merge	3,021	85	108.7%	2,084	77	109.1%				60.7	0.6	27.7	0.6	C
20 I-80 EB - SR-65 to Rocklin Rd	Basic	5,104	112	108.8%							63.4	0.1	23.5	0.4	C
22 I-80 EB - Rocklin Rd Off-ramp	Diverge	5,118	112	109.1%				1,780	74	107.9%	63.3	0.6	22.1	0.4	C
23 I-80 EB - Rocklin Rd Off to On-ramp	Basic	3,349	102	110.2%							63.4	0.5	19.4	0.7	C
24 I-80 EB - Rocklin Rd On-ramp	Merge	3,351	104	110.2%	182	3	95.5%				61.8	0.3	19.3	0.6	B
25 I-80 EB - Rocklin Rd to Sierra College Blvd	Basic	3,535	112	109.5%							63.4	0.3	19.7	0.7	C
26 I-80 EB - Sierra College Blvd Off-ramp	Diverge	3,537	113	109.5%				659	48	109.9%	62.5	1.0	20.8	0.7	C
27 I-80 EB - Sierra College Blvd Off to On-ramp	Basic	2,882	100	109.6%							63.7	0.4	16.8	0.6	B
28 I-80 EB - Sierra College Blvd SB On-ramp	Merge	2,883	98	109.6%	139	5	92.5%				62.8	0.3	15.6	0.6	B
29 I-80 EB - Sierra College Blvd NB On-ramp	Merge	3,021	96	108.7%	523	19	106.8%				62.0	0.2	17.6	0.7	B
38 I-80 WB - Sierra College Blvd Off-ramp	Diverge	5,378	27	105.9%				1,115	57	107.2%	56.0	2.1	28.3	1.0	D
39 I-80 WB - Sierra College Blvd Off to On-ramp	Basic	4,259	68	105.4%							62.0	0.6	23.8	0.3	C
40 I-80 WB - Sierra College Blvd NB On-ramp	Merge	4,259	68	105.4%	50	4	82.8%				63.3	0.2	21.0	0.5	C
41 I-80 WB - Sierra College Blvd SB On-ramp	Merge	4,305	70	105.0%	335	13	101.5%				61.6	0.5	22.4	0.6	C
42 I-80 WB - Sierra College Blvd to Rocklin Rd	Basic	4,636	71	104.7%							62.6	0.3	25.4	0.5	C
43 I-80 WB - Rocklin Rd Off-ramp	Diverge	4,635	75	104.6%				292	31	104.2%	61.7	0.6	26.0	0.9	C
44 I-80 WB - Rocklin Rd Off to On-ramp	Basic	4,338	89	104.5%							63.2	0.2	23.6	0.6	C
45 I-80 WB - Rocklin Rd On-ramp	Merge	4,337	91	104.5%	976	49	98.6%				61.0	0.7	24.7	0.7	C
46 I-80 WB - Rocklin Rd to HOV Lane Start	Basic	5,307	115	103.2%							61.8	0.7	27.3	0.8	D
47 I-80 WB - HOV Lane Start to SR-65	Basic	5,305	129	103.2%							62.5	0.4	22.1	0.4	C
48 I-80 WB - SR-65 Off-ramp	Diverge	5,303	130	103.2%				1,700	92	103.7%	63.5	0.3	20.4	0.3	C
49 I-80 WB - SR-65 Off to On-ramp	Basic	3,598	127	102.8%							63.8	0.1	17.9	0.3	B
60 I-80 WB - SR-65 to Atlantic St	Weave	3,593	119	102.7%	5,765	164	105.6%	490	41	102.1%	58.8	0.6	23.8	0.6	C
62 I-80 WB - Atlantic St EB Off-ramp	Diverge	8,805	199	103.8%				1,297	68	103.7%	60.1	1.6	29.6	1.6	D
63 I-80 WB - Atlantic St EB Off to On-ramp	Basic	7,502	170	103.8%							62.3	0.6	26.5	1.0	D
64 I-80 WB - Atlantic St On-ramp	Merge	7,501	169	103.8%	885	37	106.6%				59.9	1.5	35.8	1.1	E
65 I-80 WB - Douglas Blvd Off-ramp	Diverge	8,383	175	104.0%				1,167	61	98.9%	61.2	0.4	32.0	0.7	D
66 I-80 WB - Douglas Blvd Off to On-ramp	Basic	7,213	172	104.8%							63.1	0.2	26.7	0.5	D
67 I-80 WB - Douglas Blvd WB On-ramp	Merge	7,213	170	104.8%	952	58	105.7%				61.0	0.4	27.2	0.7	C
68 I-80 WB - Douglas Blvd EB On-ramp	Merge	8,167	173	105.0%	460	43	109.4%				61.3	0.7	31.3	0.9	D
69 I-80 WB - Douglas Blvd to Riverside Ave	Basic	8,627	133	105.2%							62.0	0.4	31.5	0.7	D
70 I-80 WB - Riverside Ave Off-ramp	Diverge	8,637	167	105.3%				1,061	70	100.1%	62.6	0.1	32.8	0.5	D
71 I-80 WB - Riverside Ave Off to On-ramp	Basic	7,575	165	106.1%							63.0	0.1	27.1	0.6	D
72 I-80 WB - Riverside Ave NB On-ramp	Merge	7,578	164	106.1%	208	9	83.2%				62.9	0.2	26.1	0.6	C
73 I-80 WB - Riverside Ave SB On-ramp	Merge	7,787	166	105.4%	772	9	100.2%				62.5	0.3	32.2	0.9	D
74 I-80 WB - Riverside Ave to Antelope Rd	Basic	8,567	172	105.0%							61.6	0.3	32.1	0.7	D
75 I-80 WB - Antelope Rd Off-ramp	Diverge	8,572	167	105.0%				460	40	88.5%	59.1	5.9	35.6	4.9	E
76 I-80 WB - Antelope Rd Off to On-ramp	Basic	8,127	151	106.4%							54.8	9.3	36.6	10.3	E
77 I-80 WB - Antelope Rd WB On-ramp	Merge	8,148	164	106.7%	552	2	104.1%				43.9	13.4	53.0	20.3	F
78 I-80 WB - Antelope Rd to Truck Scales	Weave	8,748	183	107.1%	443	16	88.6%	93	19	84.8%	35.9	7.1	58.9	10.5	F
79 I-80 WB - Truck Scales Off to On-ramp	Basic	9,245	163	108.0%							31.8	3.0	77.3	7.2	F
80 I-80 WB - Truck Scales On-ramp	Merge	9,295	173	108.6%	94	19	85.5%				27.1	1.0	87.9	3.8	F
81 I-80 WB - Truck Scales to Elkhorn Blvd	Basic	9,471	169	109.2%							39.7	1.0	58.6	1.4	F
82 I-80 WB - Elkhorn Blvd Off-ramp	Diverge	9,479	168	109.3%				1,134	66	110.1%	55.3	2.6	34.4	1.4	D
83 I-80 WB - Elkhorn Blvd Off to On-ramp	Basic	8,367	193	109.5%							50.9	15.4	46.5	22.9	F
84 I-80 WB - Elkhorn Blvd WB On-ramp	Merge	8,388	184	109.8%	753	7	95.3%				46.5	16.7	53.8	28.6	F
85 I-80 WB - Elkhorn Blvd EB On-ramp	Merge	9,174	199	108.8%	810	18	98.8%				47.2	15.5	55.6	19.3	F

Notes: Average density reported for the analysis area only: for example, within the ramp influence area and not including the HOV lane.
Mainline volume is the upstream served volume for all lanes.

VISSIM Post-Processor
Average Results from 10 Runs
Freeway Operations Summary

SR 65 Widening
Design Year - GP Lane Alternative
AM Peak Hour

Location	Facility Type	Mainline Volume (vph)			On-ramp Volume (vph)			Off-ramp Volume (vph)			Speed (mph)		Density (vplpm)		LOS
		Avg.	St. Dev.	%	Avg.	St. Dev.	%	Avg.	St. Dev.	%	Avg.	St. Dev.	Avg.	St. Dev.	
100 SR-65 NB - EB I-80 Connector	Basic	3,363	106	108.5%							62.4	0.3	28.6	1.0	D
101 SR-65 NB - Eureka Rd On-ramp	Merge	3,364	104	108.5%	1,007	69	105.9%				48.7	0.2	32.4	1.1	D
102 SR-65 NB - WB I-80 Connector	Basic	1,700	89	103.7%							53.1	0.1	18.1	0.9	C
103 SR-65 NB - I-80 to Stanford Ranch Rd	Weave	4,367	121	107.8%	2,286	98	104.9%	836	63	103.2%	59.5	0.6	27.7	0.8	C
106 SR-65 NB - Stanford Ranch Rd Off to On-ramp	Basic	5,819	123	107.4%							62.6	0.1	30.4	0.8	D
107 SR-65 NB - Stanford Ranch Rd to Pleasant Grove Blvd	Weave	5,822	123	107.4%	754	36	104.7%	1,054	57	98.5%	61.3	1.2	29.9	1.1	D
110 SR-65 NB - Pleasant Grove Blvd Off to On-ramp	Basic	5,536	142	109.2%							56.7	3.1	32.2	1.5	D
111 SR-65 NB - Pleasant Grove Blvd On-ramp	Merge	5,539	143	109.2%	282	27	97.4%				61.0	1.3	31.1	0.9	D
112 SR-65 NB - Blue Oaks Blvd Off-ramp	Diverge	5,821	140	108.6%				2,341	78	111.5%	62.8	0.4	27.5	0.7	C
114 SR-65 NB - Blue Oaks Blvd Off to On-ramp	Basic	3,481	120	106.8%							63.6	0.3	20.0	1.0	C
115 SR-65 NB - Blue Oaks Blvd On-ramp	Merge	3,479	121	106.7%	626	41	100.9%				62.8	0.2	17.8	0.5	B
116 SR-65 NB - Blue Oaks Blvd to Sunset Blvd	Basic	4,104	122	105.8%							63.6	0.2	19.2	0.5	C
118 SR-65 NB - Sunset Blvd Off-ramp	Diverge	4,103	123	105.8%				1,449	70	108.1%	63.8	0.2	19.5	0.4	B
119 SR-65 NB - Sunset Blvd Off to On-ramp	Basic	2,659	108	104.7%							64.0	0.1	14.6	0.4	B
120 SR-65 NB - Sunset Blvd EB On-ramp	Merge	2,659	105	104.7%	159	23	99.3%				63.5	0.3	15.2	0.4	B
121 SR-65 NB - Sunset Blvd to Whitney Ranch Pkwy	Weave	2,816	105	104.3%	292	19	108.3%	789	61	97.4%	63.8	0.1	14.2	0.3	B
124 SR-65 NB - Whitney Ranch Pkwy Off to On-ramp	Basic	2,317	84	107.3%							64.0	0.1	13.3	0.4	B
125 SR-65 NB - Whitney Ranch Pkwy EB On-ramp	Merge	2,317	86	107.3%	522	26	106.6%				62.2	0.4	15.9	0.6	B
126 SR-65 NB - Whitney Ranch Pkwy to Twelve Bridges Dr	Weave	2,837	95	107.0%	467	16	108.5%	672	54	89.6%	63.6	0.2	15.5	0.4	B
129 SR-65 NB - Twelve Bridges Dr Off to On-ramp	Basic	2,640	85	113.3%							63.8	0.1	16.3	0.4	B
130 SR-65 NB - Twelve Bridges Dr to Lincoln Blvd	Weave	2,641	87	113.3%	942	36	107.1%	861	51	113.3%	63.2	0.3	17.2	0.5	B
133 SR-65 NB - Lincoln Blvd to Ferrari Ranch Rd	Basic	2,719	94	111.0%							63.2	0.3	21.5	0.9	C
134 SR-65 NB - Ferrari Ranch Rd Off-ramp	Diverge	2,720	94	111.0%				1,186	76	105.0%	63.7	0.2	18.4	0.7	B
135 SR-65 NB - Ferrari Ranch Rd Off to On-ramp	Basic	1,541	68	116.8%							64.0	0.2	15.1	0.5	B
136 SR-65 NB - Ferrari Ranch Rd On-ramp	Merge	1,543	69	116.9%	181	5	106.2%				61.9	0.7	15.6	0.5	B
150 SR-65 SB - Ferrari Ranch Rd Off-ramp	Diverge	2,145	44	114.7%				143	20	102.0%	62.7	0.3	27.2	0.4	C
151 SR-65 SB - Ferrari Ranch Rd Off to On-ramp	Basic	2,003	49	115.8%							63.0	0.2	25.8	0.4	C
152 SR-65 SB - Ferrari Ranch Rd WB On-ramp	Merge	2,004	55	115.9%	1,162	20	104.7%				60.5	0.4	25.7	0.4	C
153 SR-65 SB - Ferrari Ranch Rd EB On-ramp	Merge	3,167	55	111.5%	1,044	26	92.4%				58.1	1.7	29.3	1.0	D
154 SR-65 SB - Ferrari Ranch Rd to Lincoln Blvd	Basic	4,217	75	106.2%							62.7	0.3	30.9	0.5	D
156 SR-65 SB - Lincoln Blvd to Twelve Bridges Dr	Weave	4,219	73	106.3%	1,237	69	107.6%	948	50	108.9%	55.2	2.7	32.8	2.0	D
159 SR-65 SB - Twelve Bridges Dr Off to On-ramp	Basic	4,509	112	106.1%							61.7	0.8	29.9	0.5	D
160 SR-65 SB - Twelve Bridges Dr to Placer Pkwy	Weave	4,508	116	106.1%	1,212	52	113.2%	1,119	77	110.8%	61.0	0.5	29.1	0.3	D
163 SR-65 SB - Placer Pkwy Off to On-ramp	Basic	4,601	109	106.7%							62.8	0.1	28.1	0.5	D
164 SR-65 SB - Placer Pkwy WB On-ramp	Merge	4,601	111	106.7%	413	30	108.6%				60.7	1.4	31.8	1.0	D
165 SR-65 SB - Placer Pkwy to Sunset Blvd	Weave	5,017	126	107.0%	635	28	111.4%	843	57	108.1%	60.6	0.5	29.3	0.7	D
168 SR-65 SB - Sunset Blvd Off to On-ramp	Basic	4,805	106	107.3%							62.3	1.0	29.3	1.0	D
169 SR-65 SB - Sunset Blvd WB On-ramp	Merge	4,805	113	107.3%	767	27	112.8%				57.7	6.8	34.4	5.3	D
170 SR-65 SB - Sunset Blvd to Blue Oaks Blvd	Weave	5,576	117	108.1%	543	17	98.6%	1,115	54	109.4%	61.9	0.4	28.8	0.7	D
173 SR-65 SB - Blue Oaks Blvd Off to On-ramp	Basic	4,996	126	106.5%							62.4	0.2	29.4	0.7	D
174 SR-65 SB - Blue Oaks Blvd WB On-ramp	Merge	4,996	121	106.5%	578	33	109.1%				58.8	2.2	31.9	1.5	D
175 SR-65 SB - Blue Oaks Blvd WB to EB On-ramp	Basic	5,579	117	106.9%							62.2	0.3	32.0	0.7	D
176 SR-65 SB - Blue Oaks Blvd EB On-ramp	Merge	5,579	116	106.9%	1,375	53	102.6%				60.8	0.4	31.5	0.8	D
177 SR-65 SB - Pleasant Grove Blvd Off-ramp	Diverge	6,957	120	106.0%				863	55	110.6%	59.4	2.8	32.3	2.1	D
178 SR-65 SB - Pleasant Grove Blvd Off to On-ramp	Basic	6,096	111	105.5%							58.3	6.0	29.6	5.1	D
179 SR-65 SB - Pleasant Grove Blvd WB On-ramp	Merge	6,094	105	105.4%	765	45	103.4%				42.4	10.3	46.3	11.1	F
180 SR-65 SB - Pleasant Grove Blvd EB On-ramp	Merge	6,860	130	105.2%	839	43	103.6%				43.0	10.1	46.1	11.6	F
181 SR-65 SB - Pleasant Grove Blvd to Galleria Blvd	Basic	7,701	171	105.1%							58.2	1.4	36.4	1.2	E
182 SR-65 SB - Galleria Blvd Off-ramp	Diverge	7,700	169	105.0%				1,389	62	102.9%	60.3	2.7	33.2	1.7	D
183 SR-65 SB - Galleria Blvd Off to On-ramp	Basic	6,308	155	105.5%							60.0	1.8	36.0	1.1	E
184 SR-65 SB - Galleria Blvd to I-80	Weave	6,307	151	105.5%	731	33	101.6%	4,971	152	103.8%	60.7	1.2	29.2	0.8	D
187 SR-65 SB - EB I-80 Connector	Basic	2,080	77	108.9%							51.1	1.1	29.8	1.2	D
188 SR-65 SB - WB I-80 Connector	Basic	4,091	139	100.5%							54.0	0.8	27.8	1.5	D

Notes: Average density reported for the analysis area only: for example, within the ramp influence area and not including the HOV lane.
Mainline volume is the upstream served volume for all lanes.

VISSIM Post-Processor
Average Results from 10 Runs
Freeway Operations Summary

SR 65 Widening
Design Year - General Purpose Lane Alternative
PM Peak Hour

Location	Facility Type	Mainline Volume (vph)			On-ramp Volume (vph)			Off-ramp Volume (vph)			Speed (mph)		Density (vplpm)		LOS
		Avg.	St. Dev.	%	Avg.	St. Dev.	%	Avg.	St. Dev.	%	Avg.	St. Dev.	Avg.	St. Dev.	
1 I-80 EB - Auburn Blvd On-ramp	Merge	8,072	52	102.0%	1,043	10	99.3%				61.4	1.2	30.5	0.8	D
2 I-80 EB - Auburn Blvd to Douglas Blvd	Basic	9,095	65	101.5%							58.5	6.3	35.6	6.1	E
3 I-80 EB - Douglas Blvd EB Off-ramp	Diverge	9,075	100	101.3%				1,146	86	99.6%	54.6	8.7	41.7	18.3	E
4 I-80 EB - Douglas Blvd WB Off-ramp	Diverge	7,920	111	101.4%				387	41	99.3%	62.1	0.8	26.7	0.7	C
5 I-80 EB - Douglas Blvd Off to On-ramp	Basic	7,532	124	101.5%							62.8	0.3	27.1	0.4	D
6 I-80 EB - Douglas Blvd to Eureka Rd	Weave	7,533	140	101.5%	1,751	46	92.6%	1,748	68	101.6%	62.0	0.4	26.6	0.4	C
7 I-80 EB CD - Eureka Rd to Taylor Rd/SR-65	Weave	1,072	53	104.0%	1,572	88	97.6%	1,303	49	101.8%	60.3	1.0	20.7	0.5	C
8 I-80 EB - Eureka Rd to SR-65	Basic	7,537	153	99.3%							60.0	2.3	32.2	1.3	D
9 I-80 EB - HOV Connector Off-ramp	Diverge	7,533	141	99.3%				1,070	63	97.3%	54.3	4.6	34.9	3.8	D
10 I-80 EB - SR-65 Off-ramp	Diverge	6,461	130	99.6%				3,701	104	101.7%	61.2	1.2	25.2	0.8	C
11 I-80 EB - SR-65 Off-ramp to Eureka Rd On-ramp	Basic	2,755	102	96.7%							63.9	0.2	16.1	0.5	B
17 I-80 EB - Eureka Rd On-ramp	Merge	2,752	111	96.6%	707	43	102.4%				63.3	0.2	15.3	0.7	B
18 I-80 EB - Eureka Rd On-ramp to SR-65 On-ramp	Basic	3,455	120	97.6%							63.7	0.1	17.0	0.7	B
19 I-80 EB - SR-65 On-ramp	Merge	3,455	117	97.6%	2,672	94	99.3%				58.2	1.0	32.3	0.9	D
20 I-80 EB - SR-65 to Rocklin Rd	Basic	6,127	137	98.3%							62.9	0.3	27.0	0.4	D
22 I-80 EB - Rocklin Rd Off-ramp	Diverge	6,111	142	98.1%				1,678	81	99.3%	62.9	0.4	26.4	0.5	C
23 I-80 EB - Rocklin Rd Off to On-ramp	Basic	4,431	123	97.6%							62.9	0.4	26.2	0.6	D
24 I-80 EB - Rocklin Rd On-ramp	Merge	4,427	114	97.5%	261	25	100.2%				59.0	1.3	26.3	0.9	C
25 I-80 EB - Rocklin Rd to Sierra College Blvd	Basic	4,683	113	97.6%							62.7	0.3	27.0	0.6	D
26 I-80 EB - Sierra College Blvd Off-ramp	Diverge	4,684	114	97.6%				551	39	87.4%	59.7	2.3	28.9	1.3	D
27 I-80 EB - Sierra College Blvd Off to On-ramp	Basic	4,121	115	98.8%							62.6	0.4	23.5	0.7	C
28 I-80 EB - Sierra College Blvd SB On-ramp	Merge	4,121	117	98.8%	324	8	95.3%				59.7	0.9	22.8	1.0	C
29 I-80 EB - Sierra College Blvd NB On-ramp	Merge	4,445	112	98.6%	884	18	102.7%				57.0	2.4	28.9	1.9	D
38 I-80 WB - Sierra College Blvd Off-ramp	Diverge	4,080	23	106.0%				760	43	102.7%	59.6	0.8	22.2	0.5	C
39 I-80 WB - Sierra College Blvd Off to On-ramp	Basic	3,313	58	106.5%							63.1	0.4	20.5	0.4	C
40 I-80 WB - Sierra College Blvd NB On-ramp	Merge	3,314	60	106.6%	403	10	100.6%				61.9	0.5	19.5	0.6	B
41 I-80 WB - Sierra College Blvd SB On-ramp	Merge	3,717	63	105.9%	438	9	97.4%				62.1	0.5	21.7	0.7	C
42 I-80 WB - Sierra College Blvd to Rocklin Rd	Basic	4,153	64	104.9%							62.9	0.2	23.9	0.8	C
43 I-80 WB - Rocklin Rd Off-ramp	Diverge	4,151	63	104.8%				302	31	104.2%	62.3	0.6	24.7	0.9	C
44 I-80 WB - Rocklin Rd Off to On-ramp	Basic	3,847	68	104.8%							63.3	0.1	22.3	0.6	C
45 I-80 WB - Rocklin Rd On-ramp	Merge	3,847	70	104.8%	1,645	46	103.5%				57.9	0.9	28.8	0.6	D
46 I-80 WB - Rocklin Rd to HOV Lane Start	Basic	5,489	84	104.4%							57.1	3.8	33.4	2.8	D
47 I-80 WB - HOV Lane Start to SR-65	Basic	5,482	88	104.2%							59.9	0.8	23.6	0.3	C
48 I-80 WB - SR-65 Off-ramp	Diverge	5,479	87	104.2%				2,349	69	102.6%	63.7	0.2	21.3	0.4	C
49 I-80 WB - SR-65 Off to On-ramp	Basic	3,129	83	105.3%							63.8	0.1	18.1	0.5	C
60 I-80 WB - SR-65 to Atlantic St	Weave	3,127	82	105.3%	5,159	128	98.6%	518	47	97.7%	59.1	0.6	23.9	0.5	C
62 I-80 WB - Atlantic St EB Off-ramp	Diverge	7,874	163	102.7%				1,315	73	102.0%	59.3	2.7	29.7	4.5	D
63 I-80 WB - Atlantic St EB Off to On-ramp	Basic	6,561	149	102.8%							62.8	0.4	25.0	0.5	C
64 I-80 WB - Atlantic St On-ramp	Merge	6,560	148	102.8%	1,257	59	103.9%				57.0	3.5	38.0	2.7	E
65 I-80 WB - Douglas Blvd Off-ramp	Diverge	7,812	169	102.9%				1,229	63	102.4%	59.4	2.9	32.2	2.7	D
66 I-80 WB - Douglas Blvd Off to On-ramp	Basic	6,583	166	103.0%							63.1	0.4	26.2	0.7	D
67 I-80 WB - Douglas Blvd WB On-ramp	Merge	6,583	163	103.0%	1,208	65	89.4%				58.6	2.3	28.2	1.9	D
68 I-80 WB - Douglas Blvd EB On-ramp	Merge	7,796	171	100.7%	752	39	101.6%				58.8	4.5	35.2	4.1	E
69 I-80 WB - Douglas Blvd to Riverside Ave	Basic	8,548	133	100.8%							61.0	0.4	33.7	0.8	D
70 I-80 WB - Riverside Ave Off-ramp	Diverge	8,542	178	100.7%				1,311	77	103.2%	62.4	0.6	34.5	1.1	D
71 I-80 WB - Riverside Ave Off to On-ramp	Basic	7,226	177	100.2%							63.0	0.3	27.5	0.8	D
72 I-80 WB - Riverside Ave NB On-ramp	Merge	7,221	173	100.1%	200	0	100.0%				63.2	0.1	24.6	0.8	C
73 I-80 WB - Riverside Ave SB On-ramp	Merge	7,416	168	100.1%	526	8	99.3%				60.1	1.2	29.4	0.6	D
74 I-80 WB - Riverside Ave to Antelope Rd	Basic	7,948	156	100.1%							61.5	0.4	30.6	0.7	D
75 I-80 WB - Antelope Rd Off-ramp	Diverge	7,947	156	100.1%				1,147	59	100.6%	61.5	1.1	31.7	0.8	D
76 I-80 WB - Antelope Rd Off to On-ramp	Basic	6,799	154	100.0%							62.7	0.4	26.4	0.4	D
77 I-80 WB - Antelope Rd WB On-ramp	Merge	6,800	157	100.0%	341	4	97.5%				60.7	0.8	24.3	1.0	C
78 I-80 WB - Antelope Rd to Truck Scales	Weave	7,138	161	99.8%	528	13	99.6%	78	16	70.9%	62.0	0.2	25.9	0.5	C
79 I-80 WB - Truck Scales Off to On-ramp	Basic	7,585	154	100.2%							62.7	0.1	28.6	0.5	D
80 I-80 WB - Truck Scales On-ramp	Merge	7,584	150	100.2%	78	14	71.0%				62.1	0.6	29.0	0.7	D
81 I-80 WB - Truck Scales to Elkhorn Blvd	Basic	7,661	138	99.7%							60.0	1.6	31.2	0.9	D
82 I-80 WB - Elkhorn Blvd Off-ramp	Diverge	7,663	134	99.8%				1,222	58	97.8%	60.9	1.6	28.2	1.0	D
83 I-80 WB - Elkhorn Blvd Off to On-ramp	Basic	6,440	118	100.2%							62.3	1.0	25.4	0.5	C
84 I-80 WB - Elkhorn Blvd WB On-ramp	Merge	6,442	123	100.2%	898	5	99.8%				55.7	1.4	28.0	1.1	C
85 I-80 WB - Elkhorn Blvd EB On-ramp	Merge	7,345	127	100.2%	581	10	100.1%				61.6	0.6	29.5	0.6	D

Notes: Average density reported for the analysis area only: for example, within the ramp influence area and not including the HOV lanes.
Mainline volume is the upstream served volume for all lanes.

VISSIM Post-Processor
Average Results from 10 Runs
Freeway Operations Summary

SR 65 Widening
Design Year - General Purpose Lane Alternative
PM Peak Hour

	Location	Facility Type	Mainline Volume (vph)			On-ramp Volume (vph)			Off-ramp Volume (vph)			Speed (mph)		Density (vplpm)		LOS
			Avg.	St. Dev.	%	Avg.	St. Dev.	%	Avg.	St. Dev.	%	Avg.	St. Dev.	Avg.	St. Dev.	
100	SR-65 NB - EB I-80 Connector	Basic	3,702	103	101.7%							61.8	0.8	31.7	0.9	D
101	SR-65 NB - Eureka Rd On-ramp	Merge	3,701	105	101.7%	1,337	80	96.9%				48.4	0.1	36.0	0.8	E
102	SR-65 NB - WB I-80 Connector	Basic	2,348	71	102.5%							52.1	0.3	24.1	0.7	C
103	SR-65 NB - I-80 to Stanford Ranch Rd	Weave	5,041	144	100.4%	3,418	79	100.8%	1,440	73	100.0%	56.4	1.4	32.5	1.3	D
106	SR-65 NB - Stanford Ranch Rd Off to On-ramp	Basic	7,018	143	101.7%							62.5	0.2	32.6	0.6	D
107	SR-65 NB - Stanford Ranch Rd to Pleasant Grove Blvd	Weave	7,021	146	100.7%	1,433	60	100.9%	1,597	69	101.1%	59.1	1.9	34.4	1.4	D
110	SR-65 NB - Pleasant Grove Blvd Off to On-ramp	Basic	6,858	144	100.7%							58.0	3.3	34.4	1.7	D
111	SR-65 NB - Pleasant Grove Blvd On-ramp	Merge	6,861	143	100.7%	548	30	99.7%				59.0	2.7	34.7	2.1	D
112	SR-65 NB - Blue Oaks Blvd Off-ramp	Diverge	7,416	157	100.8%				2,551	88	98.9%	62.2	0.4	31.9	0.4	D
114	SR-65 NB - Blue Oaks Blvd Off to On-ramp	Basic	4,865	120	101.8%							63.0	0.3	26.8	0.6	D
115	SR-65 NB - Blue Oaks Blvd On-ramp	Merge	4,866	122	101.8%	1,030	64	103.0%				61.9	0.4	24.4	0.5	C
116	SR-65 NB - Blue Oaks Blvd to Sunset Blvd	Basic	5,891	141	101.9%							62.7	0.3	25.9	0.6	C
118	SR-65 NB - Sunset Blvd Off-ramp	Diverge	5,888	151	101.9%				1,285	71	102.8%	63.1	0.1	26.1	0.6	C
119	SR-65 NB - Sunset Blvd Off to On-ramp	Basic	4,597	148	101.5%							63.0	0.1	25.0	0.7	C
120	SR-65 NB - Sunset Blvd EB On-ramp	Merge	4,594	146	101.4%	430	27	102.4%				61.1	0.9	27.2	0.9	C
121	SR-65 NB - Sunset Blvd to Whitney Ranch Pkwy	Weave	5,027	130	101.6%	522	45	106.5%	1,196	63	102.2%	61.9	0.7	25.8	0.8	C
124	SR-65 NB - Whitney Ranch Pkwy Off to On-ramp	Basic	4,348	128	101.8%							63.1	0.2	24.6	0.6	C
125	SR-65 NB - Whitney Ranch Pkwy EB On-ramp	Merge	4,346	131	101.8%	430	35	99.9%				62.3	0.8	26.2	0.8	C
126	SR-65 NB - Whitney Ranch Pkwy to Twelve Bridges Dr	Weave	4,769	119	101.5%	702	38	103.3%	1,101	58	101.9%	62.6	0.3	24.1	0.6	C
129	SR-65 NB - Twelve Bridges Dr Off to On-ramp	Basic	4,353	126	101.2%							62.9	0.1	24.7	0.7	C
130	SR-65 NB - Twelve Bridges Dr to Lincoln Blvd	Weave	4,350	115	101.2%	991	53	96.2%	1,446	78	101.8%	62.4	0.4	23.6	0.6	C
133	SR-65 NB - Lincoln Blvd to Ferrari Ranch Rd	Basic	3,892	106	99.5%							61.5	1.1	28.3	0.9	D
134	SR-65 NB - Ferrari Ranch Rd Off-ramp	Diverge	3,889	110	99.5%				2,018	85	98.9%	62.9	0.2	23.8	0.7	C
135	SR-65 NB - Ferrari Ranch Rd Off to On-ramp	Basic	1,865	89	99.7%							64.0	0.2	15.3	0.9	B
136	SR-65 NB - Ferrari Ranch Rd On-ramp	Merge	1,865	86	99.7%	212	11	100.7%				61.6	0.9	16.0	0.9	B
150	SR-65 SB - Ferrari Ranch Rd Off-ramp	Diverge	2,071	56	100.5%				264	26	97.9%	63.6	0.1	18.4	0.4	B
151	SR-65 SB - Ferrari Ranch Rd Off to On-ramp	Basic	1,806	63	100.9%							64.0	0.1	15.6	0.5	B
152	SR-65 SB - Ferrari Ranch Rd WB On-ramp	Merge	1,806	62	100.9%	697	17	98.1%				62.0	0.2	15.5	0.4	B
153	SR-65 SB - Ferrari Ranch Rd EB On-ramp	Merge	2,503	62	100.1%	668	19	98.2%				61.6	0.2	16.2	0.4	B
154	SR-65 SB - Ferrari Ranch Rd to Lincoln Blvd	Basic	3,170	68	99.7%							64.0	0.1	18.0	0.3	B
156	SR-65 SB - Lincoln Blvd to Twelve Bridges Dr	Weave	3,173	71	99.8%	762	50	99.0%	869	51	99.9%	62.2	0.7	17.2	0.3	B
159	SR-65 SB - Twelve Bridges Dr Off to On-ramp	Basic	3,067	76	99.6%							63.6	0.6	17.0	0.4	B
160	SR-65 SB - Twelve Bridges Dr to Placer Pkwy	Weave	3,070	79	99.7%	876	36	93.2%	1,067	63	97.0%	61.0	1.0	21.7	0.9	C
163	SR-65 SB - Placer Pkwy Off to On-ramp	Basic	2,876	100	98.5%							63.8	0.2	15.5	0.7	B
164	SR-65 SB - Placer Pkwy WB On-ramp	Merge	2,877	101	98.5%	413	32	103.1%				62.6	0.3	18.6	0.8	B
165	SR-65 SB - Placer Pkwy to Sunset Blvd	Weave	3,292	102	99.1%	759	57	101.2%	626	44	97.8%	62.8	0.1	18.7	0.7	B
168	SR-65 SB - Sunset Blvd Off to On-ramp	Basic	3,425	111	99.8%							63.5	0.1	18.7	0.7	C
169	SR-65 SB - Sunset Blvd WB On-ramp	Merge	3,425	110	99.9%	1,016	42	105.8%				60.7	0.5	24.0	0.5	C
170	SR-65 SB - Sunset Blvd to Blue Oaks Blvd	Weave	4,439	117	101.1%	1,134	39	101.2%	877	60	98.6%	62.6	0.2	24.7	0.6	C
173	SR-65 SB - Blue Oaks Blvd Off to On-ramp	Basic	4,685	117	101.4%							62.9	0.1	26.2	0.7	D
174	SR-65 SB - Blue Oaks Blvd WB On-ramp	Merge	4,684	116	101.4%	375	23	98.8%				61.5	0.2	27.5	0.8	C
175	SR-65 SB - Blue Oaks Blvd WB to EB On-ramp	Basic	5,055	116	101.1%							62.9	0.2	27.5	0.7	D
176	SR-65 SB - Blue Oaks Blvd EB On-ramp	Merge	5,056	118	101.1%	1,414	41	98.9%				61.7	0.2	28.2	0.3	D
177	SR-65 SB - Pleasant Grove Blvd Off-ramp	Diverge	6,474	120	100.7%				626	43	96.3%	59.9	2.6	29.2	1.3	D
178	SR-65 SB - Pleasant Grove Blvd Off to On-ramp	Basic	5,857	99	101.3%							62.4	0.9	24.6	0.6	C
179	SR-65 SB - Pleasant Grove Blvd WB On-ramp	Merge	5,855	103	101.3%	652	45	101.8%				59.7	1.3	30.3	1.0	D
180	SR-65 SB - Pleasant Grove Blvd EB On-ramp	Merge	6,508	117	101.4%	1,198	52	99.9%				53.1	6.1	33.5	4.6	D
181	SR-65 SB - Pleasant Grove Blvd to Galleria Blvd	Basic	7,705	109	101.1%							60.6	0.5	33.5	0.5	D
182	SR-65 SB - Galleria Blvd Off-ramp	Diverge	7,705	108	101.1%				1,650	70	100.6%	62.4	0.3	31.7	0.4	D
183	SR-65 SB - Galleria Blvd Off to On-ramp	Basic	6,051	121	101.2%							61.3	0.6	34.4	0.7	D
184	SR-65 SB - Galleria Blvd to I-80	Weave	6,054	115	101.2%	1,185	58	96.3%	4,563	115	101.0%	60.5	1.2	28.3	0.8	D
187	SR-65 SB - EB I-80 Connector	Basic	2,674	86	99.4%							47.6	0.9	38.6	1.3	E
188	SR-65 SB - WB I-80 Connector	Basic	3,921	112	98.5%							54.2	0.6	25.1	0.8	C

Notes: Average density reported for the analysis area only: for example, within the ramp influence area and not including the HOV lane.
Mainline volume is the upstream served volume for all lanes.

VISSIM Post-Processor
Average Results from 10 Runs
Intersection Volume and Delay

SR 65 Widening
Design Year - GP Lane Alternative
AM Peak Hour

	Intersection	Control	Volume (vph)		Percent Served	Delay (sec/veh)		Level of Service
			Demand	Served		Average	Std. Dev.	
1	Lincoln Blvd/Sterling Pkwy	Signal	2,990	3,296	110.2%	14.4	0.9	B
2	SR-65 SB Ramps/Twelve Bridges Dr	Signal	2,660	2,892	108.7%	15.8	1.1	B
3	SR-65 NB Ramps/Twelve Bridges Dr	Signal	2,655	2,819	106.2%	23.3	4.0	C
4	SR-65 SB Ramps/Sunset Blvd	Signal	3,730	4,082	109.4%	27.0	9.2	C
5	SR-65 NB Ramps/Sunset Blvd	Signal	4,005	4,412	110.2%	12.2	1.4	B
6	SR-65 SB Ramps-Washington Blvd/Blue Oaks Blvd	Signal	5,480	5,743	104.8%	59.1	8.8	E
7	SR-65 NB Ramps/Blue Oaks Blvd	Signal	3,515	3,762	107.0%	15.6	1.7	B
8	SR-65 SB Ramps/Pleasant Grove Blvd	Signal	4,615	4,763	103.2%	7.6	0.6	A
9	SR-65 NB Ramps/Pleasant Grove Blvd	Signal	3,620	3,653	100.9%	16.3	0.9	B
10	Stanford Ranch Rd/Five Star Blvd	Signal	2,755	2,874	104.3%	25.9	1.5	C
11	SR-65 NB Ramps/Stanford Ranch Rd	Signal	3,145	3,308	105.2%	11.7	1.1	B
12	SR-65 SB Ramps/Galleria Blvd	Signal	3,545	3,692	104.1%	17.2	0.6	B
13	Galleria Blvd/Antelope Creek Dr	Signal	2,805	2,890	103.0%	9.8	1.4	A
14	Galleria Blvd/Roseville Pkwy	Signal	5,326	5,725	107.5%	45.2	2.8	D
15	Creekside Ridge Dr/Roseville Pkwy	Signal	3,355	3,632	108.2%	8.2	2.2	A
16	Taylor Rd/East Roseville Pkwy	Signal	4,825	5,212	108.0%	65.8	15.6	E
17	North Sunrise Ave/East Roseville Pkwy	Signal	4,785	5,164	107.9%	34.9	3.3	C
18	Wills Rd/Atlantic St	Signal	2,265	2,445	108.0%	21.1	2.7	C
19	I-80 WB Ramps/Atlantic St	Signal	3,790	4,024	106.2%	14.3	4.1	B
20	Taylor Rd-I-80 EB Ramps/Eureka Rd	Signal	5,375	5,648	105.1%	30.0	5.3	C
21	North Sunrise Ave/Eureka Rd	Signal	5,125	5,417	105.7%	40.7	5.0	D
22	Harding Blvd/Wills Rd	Signal	2,135	2,248	105.3%	14.8	2.5	B
23	Harding Blvd/Douglas Blvd	Signal	2,720	2,974	109.3%	28.1	5.2	C
24	I-80 WB Ramps/Douglas Blvd	Signal	3,955	4,224	106.8%	18.7	3.5	B

Network Summary	
Total Demand Volume (veh/hr)	89,176
Total Volume Served (veh/hr)	94,897
Percent Served	106.4%

- Notes: 1. Volume is measured for the entire peak hour.
2. Delay is measured for the peak 15 minutes in the peak hour.

VISSIM Post-Processor
Average Results from 10 Runs
Intersection Volume and Delay

SR 65 Widening
Design Year - GP Lane Alternative
AM Peak Hour

	Intersection	Control	Volume (vph)		Percent Served	Delay (sec/veh)		Level of Service
			Demand	Served		Average	Std. Dev.	
25	I-80 EB Ramps/Douglas Blvd	Signal	4,270	4,582	107.3%	24.0	10.9	C
26	North Sunrise Ave/Douglas Blvd	Signal	4,595	4,871	106.0%	44.3	20.5	D
27	Pacific St/Woodside Dr	Signal	2,230	2,459	110.3%	7.7	0.6	A
28	Pacific St/Sunset Blvd	Signal	3,305	3,641	110.2%	25.6	1.5	C
29	Granite Dr/Rocklin Rd	Signal	2,885	3,013	104.4%	27.5	1.1	C
30	I-80 WB Ramps/Rocklin Rd	Signal	3,000	3,139	104.6%	23.5	1.9	C
31	I-80 EB Ramps/Rocklin Rd	Signal	3,195	3,446	107.9%	26.2	4.6	C
32	Aguilar Rd/Rocklin Rd	Signal	2,305	2,512	109.0%	9.6	1.2	A
33	Lincoln Blvd/SR-65 NB Off-Ramp	Signal	2,755	3,043	110.5%	9.4	1.2	A
34	Lincoln Blvd/SR-65 SB On-Ramp	Signal	1,995	2,177	109.1%	20.1	2.5	C
35	SR-65 SB Ramps/Placer Pkwy	Signal	4,010	4,395	109.6%	20.0	5.7	B
36	SR-65 NB Ramps/Whitney Ranch Pkwy	Signal	3,720	3,944	106.0%	14.9	3.0	B
40	Galleria Blvd/Berry St-Cattlemens Drwy	Signal	2,020	2,128	105.3%	10.1	1.8	B

Network Summary	
Total Demand Volume (veh/hr)	40,285
Total Volume Served (veh/hr)	43,351
Percent Served	107.6%

- Notes: 1. Volume is measured for the entire peak hour.
2. Delay is measured for the peak 15 minutes in the peak hour.

VISSIM Post-Processor
Average Results from 10 Runs
Intersection Volume and Delay

SR 65 Widening
Design Year - General Purpose Lane Alternative
PM Peak Hour

	Intersection	Control	Volume (vph)		Percent Served	Delay (sec/veh)		Level of Service
			Demand	Served		Average	Std. Dev.	
1	Lincoln Blvd/Sterling Pkwy	Signal	3,430	3,452	100.6%	17.2	0.9	B
2	SR-65 SB Ramps/Twelve Bridges Dr	Signal	2,655	2,582	97.3%	28.0	13.1	C
3	SR-65 NB Ramps/Twelve Bridges Dr	Signal	2,880	2,858	99.2%	19.6	1.1	B
4	SR-65 SB Ramps/Sunset Blvd	Signal	4,970	5,112	102.9%	15.0	3.8	B
5	SR-65 NB Ramps/Sunset Blvd	Signal	4,735	4,929	104.1%	11.4	0.8	B
6	SR-65 SB Ramps-Washington Blvd/Blue Oaks Blvd	Signal	7,110	7,193	101.2%	153.1	19.8	F
7	SR-65 NB Ramps/Blue Oaks Blvd	Signal	4,755	4,879	102.6%	49.2	39.8	D
8	SR-65 SB Ramps/Pleasant Grove Blvd	Signal	6,360	6,377	100.3%	8.1	0.6	A
9	SR-65 NB Ramps/Pleasant Grove Blvd	Signal	5,380	5,412	100.6%	13.8	0.6	B
10	Stanford Ranch Rd/Five Star Blvd	Signal	4,355	4,337	99.6%	56.7	12.2	E
11	SR-65 NB Ramps/Stanford Ranch Rd	Signal	5,590	5,609	100.3%	18.6	1.7	B
12	SR-65 SB Ramps/Galleria Blvd	Signal	6,015	5,993	99.6%	19.0	2.0	B
13	Galleria Blvd/Antelope Creek Dr	Signal	4,590	4,476	97.5%	29.4	2.0	C
14	Galleria Blvd/Roseville Pkwy	Signal	8,000	7,662	95.8%	82.4	10.6	F
15	Creekside Ridge Dr/Roseville Pkwy	Signal	4,575	4,398	96.1%	46.5	13.4	D
16	Taylor Rd/East Roseville Pkwy	Signal	6,690	6,501	97.2%	51.8	11.8	D
17	North Sunrise Ave/East Roseville Pkwy	Signal	6,330	6,369	100.6%	56.5	33.3	E
18	Wills Rd/Atlantic St	Signal	3,215	3,293	102.4%	24.8	3.1	C
19	I-80 WB Ramps/Atlantic St	Signal	4,830	4,974	103.0%	23.7	9.8	C
20	Taylor Rd-I-80 EB Ramps/Eureka Rd	Signal	6,580	6,704	101.9%	80.9	17.7	F
21	North Sunrise Ave/Eureka Rd	Signal	6,855	7,077	103.2%	103.3	26.0	F
22	Harding Blvd/Wills Rd	Signal	2,915	3,006	103.1%	16.0	1.6	B
23	Harding Blvd/Douglas Blvd	Signal	3,920	3,878	98.9%	96.2	7.4	F
24	I-80 WB Ramps/Douglas Blvd	Signal	4,715	4,553	96.6%	32.9	14.1	C

Network Summary	
Total Demand Volume (veh/hr)	121,450
Total Volume Served (veh/hr)	121,624
Percent Served	100.1%

- Notes: 1. Volume is measured for the entire peak hour.
2. Delay is measured for the peak 15 minutes in the peak hour.

VISSIM Post-Processor
Average Results from 10 Runs
Intersection Volume and Delay

SR 65 Widening
Design Year - General Purpose Lane Alternative
PM Peak Hour

	Intersection	Control	Volume (vph)		Percent Served	Delay (sec/veh)		Level of Service
			Demand	Served		Average	Std. Dev.	
25	I-80 EB Ramps/Douglas Blvd	Signal	5,445	5,078	93.3%	37.2	25.8	D
26	North Sunrise Ave/Douglas Blvd	Signal	6,285	5,738	91.3%	241.3	10.3	F
27	Pacific St/Woodside Dr	Signal	3,360	3,365	100.2%	10.8	1.2	B
28	Pacific St/Sunset Blvd	Signal	5,090	5,118	100.5%	36.7	3.7	D
29	Granite Dr/Rocklin Rd	Signal	3,970	4,134	104.1%	83.5	20.0	F
30	I-80 WB Ramps/Rocklin Rd	Signal	3,865	3,986	103.1%	62.5	15.3	E
31	I-80 EB Ramps/Rocklin Rd	Signal	3,830	3,893	101.6%	19.9	2.1	B
32	Aguilar Rd/Rocklin Rd	Signal	2,995	3,057	102.1%	31.3	7.6	C
33	Lincoln Blvd/SR-65 NB Off-Ramp	Signal	3,000	3,032	101.1%	10.4	0.4	B
34	Lincoln Blvd/SR-65 SB On-Ramp	Signal	1,580	1,588	100.5%	17.1	1.7	B
35	SR-65 SB Ramps/Placer Pkwy	Signal	4,870	4,935	101.3%	22.2	1.1	C
36	SR-65 NB Ramps/Whitney Ranch Pkwy	Signal	4,625	4,703	101.7%	21.4	2.8	C
40	Galleria Blvd/Berry St	Signal	2,940	3,001	102.1%	12.6	1.0	B

Network Summary	
Total Demand Volume (veh/hr)	51,855
Total Volume Served (veh/hr)	51,627
Percent Served	99.6%

- Notes: 1. Volume is measured for the entire peak hour.
2. Delay is measured for the peak 15 minutes in the peak hour.

Intersection 2

SR-65 SB Ramps/Twelve Bridges Dr

Signalized

Direction	Movement	Storage (ft)	Average Queue (ft)		Maximum Queue (ft)		Exceeds Storage?
			Average	Std. Dev.	Average	Std. Dev.	
SB	Left Turn	440	45	18	258	34	NO
	Through						
	Right Turn	1,500	39	20	253	34	NO

Intersection 3

SR-65 NB Ramps/Twelve Bridges Dr

Signalized

Direction	Movement	Storage (ft)	Average Queue (ft)		Maximum Queue (ft)		Exceeds Storage?
			Average	Std. Dev.	Average	Std. Dev.	
NB	Left Turn	700	20	18	157	32	NO
	Through						
	Right Turn	1,500	20	18	157	32	NO

Intersection 4

SR-65 SB Ramps/Sunset Blvd

Signalized

Direction	Movement	Storage (ft)	Average Queue (ft)		Maximum Queue (ft)		Exceeds Storage?
			Average	Std. Dev.	Average	Std. Dev.	
SB	Left Turn	360	68	8	261	24	NO
	Through						
	Right Turn	1,330	70	8	263	24	NO

Intersection 5

SR-65 NB Ramps/Sunset Blvd

Signalized

Direction	Movement	Storage (ft)	Average Queue (ft)		Maximum Queue (ft)		Exceeds Storage?
			Average	Std. Dev.	Average	Std. Dev.	
NB	Left Turn	1,400	55	5	228	32	NO
	Through						
	Right Turn	1,400	24	5	150	18	NO

Note: The "Average Queue" is calculated on a time-step basis so that queues when the approach is green (zero length) are included in the average.

Intersection 6

SR-65 SB Ramps-Washington Blvd/Blue Oaks Blvd

Signalized

Direction	Movement	Storage (ft)	Average Queue (ft)		Maximum Queue (ft)		Exceeds Storage?
			Average	Std. Dev.	Average	Std. Dev.	
SB	Left Turn	200	41	9	208	174	MAX
	Through	2,260	175	73	952	350	NO
	Right Turn	200	43	53	699	416	MAX

Intersection 7

SR-65 NB Ramps/Blue Oaks Blvd

Signalized

Direction	Movement	Storage (ft)	Average Queue (ft)		Maximum Queue (ft)		Exceeds Storage?
			Average	Std. Dev.	Average	Std. Dev.	
NB	Left Turn	400	52	19	284	48	NO
	Through						
	Right Turn	1,100	51	19	283	48	NO

Intersection 8

SR-65 SB Ramps/Pleasant Grove Blvd

Signalized

Direction	Movement	Storage (ft)	Average Queue (ft)		Maximum Queue (ft)		Exceeds Storage?
			Average	Std. Dev.	Average	Std. Dev.	
SB	Left Turn	430	31	5	158	23	NO
	Through						
	Right Turn	1,130	33	5	160	23	NO

Intersection 9

SR-65 NB Ramps/Pleasant Grove Blvd

Signalized

Direction	Movement	Storage (ft)	Average Queue (ft)		Maximum Queue (ft)		Exceeds Storage?
			Average	Std. Dev.	Average	Std. Dev.	
NB	Left Turn	1,420	48	10	194	23	NO
	Through						
	Right Turn	1,420	47	10	193	23	NO

Note: The "Average Queue" is calculated on a time-step basis so that queues when the approach is green (zero length) are included in the average.

VISSIM Post-Processor
 Average Results from 10 Runs
 Queue Length

SR 65 Widening
 Design Year - GP Lane Alternative
 AM Peak Hour

Intersection 11

SR-65 NB Ramps/Stanford Ranch Rd

Signalized

Direction	Movement	Storage (ft)	Average Queue (ft)		Maximum Queue (ft)		Exceeds Storage?
			Average	Std. Dev.	Average	Std. Dev.	
EB	Left Turn						
	Through						
	Right Turn	1,800	0	0	13	11	NO
WB	Left Turn						
	Through						
	Right Turn	1,170	30	4	179	54	NO

Intersection 12

SR-65 SB Ramps/Galleria Blvd

Signalized

Direction	Movement	Storage (ft)	Average Queue (ft)		Maximum Queue (ft)		Exceeds Storage?
			Average	Std. Dev.	Average	Std. Dev.	
EB	Left Turn						
	Through						
	Right Turn	1,130	67	8	380	64	NO
WB	Left Turn						
	Through						
	Right Turn	1,780	0	0	39	13	NO

Intersection 19

I-80 WB Ramps/Atlantic St

Signalized

Direction	Movement	Storage (ft)	Average Queue (ft)		Maximum Queue (ft)		Exceeds Storage?
			Average	Std. Dev.	Average	Std. Dev.	
NB	Left Turn						
	Through						
	Right Turn	1,150	1	1	72	228	NO
SB	Left Turn						
	Through						
	Right Turn	1,430	0	0	0	0	NO

Note: The "Average Queue" is calculated on a time-step basis so that queues when the approach is green (zero length) are included in the average.

VISSIM Post-Processor
 Average Results from 10 Runs
 Queue Length

SR 65 Widening
 Design Year - GP Lane Alternative
 AM Peak Hour

Intersection 20

Taylor Rd-I-80 EB Ramps/Eureka Rd

Signalized

Direction	Movement	Storage (ft)	Average Queue (ft)		Maximum Queue (ft)		Exceeds Storage?
			Average	Std. Dev.	Average	Std. Dev.	
NB	Left Turn	180	86	15	473	444	MAX
	Through	1,700	76	26	488	289	NO
	Right Turn	1,700	10	11	396	503	NO
SB	Left Turn	550	27	3	98	24	NO
	Through						
	Right Turn	550	36	2	183	40	NO
EB	Left Turn	1,120	36	3	127	23	NO
	Through	1,120	121	26	739	100	NO
	Right Turn	810	14	9	325	101	NO
WB	Left Turn						
	Through	1,370	98	20	632	126	NO
	Right Turn	280	0	0	29	12	NO

Intersection 24

I-80 WB Ramps/Douglas Blvd

Signalized

Direction	Movement	Storage (ft)	Average Queue (ft)		Maximum Queue (ft)		Exceeds Storage?
			Average	Std. Dev.	Average	Std. Dev.	
SB	Left Turn	1,530	90	92	429	131	NO
	Through	1,530	90	92	429	131	NO
	Right Turn	730	90	92	429	131	NO

Note: The "Average Queue" is calculated on a time-step basis so that queues when the approach is green (zero length) are included in the average.

VISSIM Post-Processor
 Average Results from 10 Runs
 Queue Length

SR 65 Widening
 Design Year - GP Lane Alternative
 AM Peak Hour

Intersection 25

I-80 EB Ramps/Douglas Blvd

Signalized

Direction	Movement	Storage (ft)	Average Queue (ft)		Maximum Queue (ft)		Exceeds Storage?
			Average	Std. Dev.	Average	Std. Dev.	
NB	Left Turn						
	Through						
	Right Turn	1,400	0	0	18	34	NO
SB	Left Turn						
	Through						
	Right Turn	1,250	13	3	103	24	NO

Intersection 30

I-80 WB Ramps/Rocklin Rd

Signalized

Direction	Movement	Storage (ft)	Average Queue (ft)		Maximum Queue (ft)		Exceeds Storage?
			Average	Std. Dev.	Average	Std. Dev.	
SB	Left Turn	700	25	5	165	70	NO
	Through						
	Right Turn	1,230	34	7	185	70	NO

Intersection 31

I-80 EB Ramps/Rocklin Rd

Signalized

Direction	Movement	Storage (ft)	Average Queue (ft)		Maximum Queue (ft)		Exceeds Storage?
			Average	Std. Dev.	Average	Std. Dev.	
NB	Left Turn	1,080	60	5	269	45	NO
	Through						
	Right Turn	1,080	49	7	280	31	NO

Note: The "Average Queue" is calculated on a time-step basis so that queues when the approach is green (zero length) are included in the average.

Intersection 33

Lincoln Blvd/SR-65 NB Off-Ramp

Signalized

Direction	Movement	Storage (ft)	Average Queue (ft)		Maximum Queue (ft)		Exceeds Storage?
			Average	Std. Dev.	Average	Std. Dev.	
WB	Left Turn	1,940	0	0	0	0	NO
	Through						
	Right Turn	1,940	24	7	157	30	NO

Intersection 35

SR-65 SB Ramps/Placer Pkwy

Signalized

Direction	Movement	Storage (ft)	Average Queue (ft)		Maximum Queue (ft)		Exceeds Storage?
			Average	Std. Dev.	Average	Std. Dev.	
SB	Left Turn	1,650	149	108	824	441	NO
	Through						
	Right Turn	1,650	150	108	825	441	NO

Intersection 36

SR-65 NB Ramps/Whitney Ranch Pkwy

Signalized

Direction	Movement	Storage (ft)	Average Queue (ft)		Maximum Queue (ft)		Exceeds Storage?
			Average	Std. Dev.	Average	Std. Dev.	
NB	Left Turn	1,620	63	11	319	51	NO
	Through						
	Right Turn	1,620	63	11	319	51	NO

Note: The "Average Queue" is calculated on a time-step basis so that queues when the approach is green (zero length) are included in the average.

Intersection 2

SR-65 SB Ramps/Twelve Bridges Dr

Signalized

Direction	Movement	Storage (ft)	Average Queue (ft)		Maximum Queue (ft)		Exceeds Storage?
			Average	Std. Dev.	Average	Std. Dev.	
SB	Left Turn	440	52	6	217	38	NO
	Through						
	Right Turn	1,500	47	7	212	38	NO

Intersection 3

SR-65 NB Ramps/Twelve Bridges Dr

Signalized

Direction	Movement	Storage (ft)	Average Queue (ft)		Maximum Queue (ft)		Exceeds Storage?
			Average	Std. Dev.	Average	Std. Dev.	
NB	Left Turn	700	25	2	97	21	NO
	Through						
	Right Turn	1,500	25	2	97	21	NO

Intersection 4

SR-65 SB Ramps/Sunset Blvd

Signalized

Direction	Movement	Storage (ft)	Average Queue (ft)		Maximum Queue (ft)		Exceeds Storage?
			Average	Std. Dev.	Average	Std. Dev.	
SB	Left Turn	360	61	1	199	24	NO
	Through						
	Right Turn	1,330	63	1	201	24	NO

Intersection 5

SR-65 NB Ramps/Sunset Blvd

Signalized

Direction	Movement	Storage (ft)	Average Queue (ft)		Maximum Queue (ft)		Exceeds Storage?
			Average	Std. Dev.	Average	Std. Dev.	
NB	Left Turn	1,400	63	2	237	37	NO
	Through						
	Right Turn	1,400	18	3	140	24	NO

Note: The "Average Queue" is calculated on a time-step basis so that queues when the approach is green (zero length) are included in the average.

Intersection 6

SR-65 SB Ramps-Washington Blvd/Blue Oaks Blvd

Signalized

Direction	Movement	Storage (ft)	Average Queue (ft)		Maximum Queue (ft)		Exceeds Storage?
			Average	Std. Dev.	Average	Std. Dev.	
SB	Left Turn	200	83	29	528	382	MAX
	Through	2,260	140	76	846	302	NO
	Right Turn	200	22	33	565	302	MAX

Intersection 7

SR-65 NB Ramps/Blue Oaks Blvd

Signalized

Direction	Movement	Storage (ft)	Average Queue (ft)		Maximum Queue (ft)		Exceeds Storage?
			Average	Std. Dev.	Average	Std. Dev.	
NB	Left Turn	400	61	6	272	54	NO
	Through						
	Right Turn	1,100	61	6	272	54	NO

Intersection 8

SR-65 SB Ramps/Pleasant Grove Blvd

Signalized

Direction	Movement	Storage (ft)	Average Queue (ft)		Maximum Queue (ft)		Exceeds Storage?
			Average	Std. Dev.	Average	Std. Dev.	
SB	Left Turn	430	30	4	134	16	NO
	Through						
	Right Turn	1,130	32	4	137	16	NO

Intersection 9

SR-65 NB Ramps/Pleasant Grove Blvd

Signalized

Direction	Movement	Storage (ft)	Average Queue (ft)		Maximum Queue (ft)		Exceeds Storage?
			Average	Std. Dev.	Average	Std. Dev.	
NB	Left Turn	1,420	51	0	194	21	NO
	Through						
	Right Turn	1,420	50	0	193	21	NO

Note: The "Average Queue" is calculated on a time-step basis so that queues when the approach is green (zero length) are included in the average.

Intersection 11

SR-65 NB Ramps/Stanford Ranch Rd

Signalized

Direction	Movement	Storage (ft)	Average Queue (ft)		Maximum Queue (ft)		Exceeds Storage?
			Average	Std. Dev.	Average	Std. Dev.	
EB	Left Turn						
	Through						
	Right Turn	1,800	0	0	25	27	NO
WB	Left Turn						
	Through						
	Right Turn	1,170	56	4	303	33	NO

Intersection 12

SR-65 SB Ramps/Galleria Blvd

Signalized

Direction	Movement	Storage (ft)	Average Queue (ft)		Maximum Queue (ft)		Exceeds Storage?
			Average	Std. Dev.	Average	Std. Dev.	
EB	Left Turn						
	Through						
	Right Turn	1,130	81	3	388	65	NO
WB	Left Turn						
	Through						
	Right Turn	1,780	6	3	166	55	NO

Intersection 19

I-80 WB Ramps/Atlantic St

Signalized

Direction	Movement	Storage (ft)	Average Queue (ft)		Maximum Queue (ft)		Exceeds Storage?
			Average	Std. Dev.	Average	Std. Dev.	
NB	Left Turn						
	Through						
	Right Turn	1,150	21	37	398	687	NO
SB	Left Turn						
	Through						
	Right Turn	1,430	0	0	0	0	NO

Note: The "Average Queue" is calculated on a time-step basis so that queues when the approach is green (zero length) are included in the average.

Intersection 20

Taylor Rd-I-80 EB Ramps/Eureka Rd

Signalized

Direction	Movement	Storage (ft)	Average Queue (ft)		Maximum Queue (ft)		Exceeds Storage?
			Average	Std. Dev.	Average	Std. Dev.	
NB	Left Turn	180	82	10	387	210	MAX
	Through	1,700	26	11	163	30	NO
	Right Turn	1,700	1	1	113	191	NO
SB	Left Turn	550	32	12	124	21	NO
	Through						
	Right Turn	550	140	83	671	89	MAX
EB	Left Turn	1,120	56	4	197	40	NO
	Through	1,120	232	27	803	101	NO
	Right Turn	810	52	14	386	101	NO
WB	Left Turn						
	Through	1,370	657	246	1,502	39	MAX
	Right Turn	280	13	15	281	282	MAX

Intersection 24

I-80 WB Ramps/Douglas Blvd

Signalized

Direction	Movement	Storage (ft)	Average Queue (ft)		Maximum Queue (ft)		Exceeds Storage?
			Average	Std. Dev.	Average	Std. Dev.	
SB	Left Turn	1,530	145	156	548	402	NO
	Through	1,530	145	156	548	402	NO
	Right Turn	730	146	157	548	402	NO

Note: The "Average Queue" is calculated on a time-step basis so that queues when the approach is green (zero length) are included in the average.

Intersection 25

I-80 EB Ramps/Douglas Blvd

Signalized

Direction	Movement	Storage (ft)	Average Queue (ft)		Maximum Queue (ft)		Exceeds Storage?
			Average	Std. Dev.	Average	Std. Dev.	
NB	Left Turn						
	Through						
	Right Turn	1,400	167	274	1,156	799	NO
SB	Left Turn						
	Through						
	Right Turn	1,250	31	10	208	172	NO

Intersection 30

I-80 WB Ramps/Rocklin Rd

Signalized

Direction	Movement	Storage (ft)	Average Queue (ft)		Maximum Queue (ft)		Exceeds Storage?
			Average	Std. Dev.	Average	Std. Dev.	
SB	Left Turn	700	75	66	335	211	NO
	Through						
	Right Turn	1,230	88	68	355	211	NO

Intersection 31

I-80 EB Ramps/Rocklin Rd

Signalized

Direction	Movement	Storage (ft)	Average Queue (ft)		Maximum Queue (ft)		Exceeds Storage?
			Average	Std. Dev.	Average	Std. Dev.	
NB	Left Turn	1,080	74	9	288	44	NO
	Through						
	Right Turn	1,080	56	4	288	33	NO

Note: The "Average Queue" is calculated on a time-step basis so that queues when the approach is green (zero length) are included in the average.

Intersection 33

Lincoln Blvd/SR-65 NB Off-Ramp

Signalized

Direction	Movement	Storage (ft)	Average Queue (ft)		Maximum Queue (ft)		Exceeds Storage?
			Average	Std. Dev.	Average	Std. Dev.	
WB	Left Turn	1,940	0	0	0	0	NO
	Through						
	Right Turn	1,940	74	4	356	91	NO

Intersection 35

SR-65 SB Ramps/Placer Pkwy

Signalized

Direction	Movement	Storage (ft)	Average Queue (ft)		Maximum Queue (ft)		Exceeds Storage?
			Average	Std. Dev.	Average	Std. Dev.	
SB	Left Turn	1,650	67	6	344	33	NO
	Through						
	Right Turn	1,650	68	6	345	33	NO

Intersection 36

SR-65 NB Ramps/Whitney Ranch Pkwy

Signalized

Direction	Movement	Storage (ft)	Average Queue (ft)		Maximum Queue (ft)		Exceeds Storage?
			Average	Std. Dev.	Average	Std. Dev.	
NB	Left Turn	1,620	127	26	494	89	NO
	Through						
	Right Turn	1,620	127	26	494	89	NO

Note: The "Average Queue" is calculated on a time-step basis so that queues when the approach is green (zero length) are included in the average.

SR 65 Capacity and Operational Improvements

**Vissim Model Results – Design Year
Alternative 3 (No Build)**

VISSIM Post-Processor
Average Values from 10 Runs
Network Statistics

SR 65 Widening
Design Year - No Build
AM Peak Period

Network Performance	Vehicle Types	Average	Std. Dev.
Number of Vehicles Served	All Vehicles	208,799	146
Travel Distance [mi]	All Vehicles	917,290	1,551
Travel Time [h]	All Vehicles	22,142	179.1
Average Speed [mph]	All Vehicles	41.4	0.4
Total Delay [h]	All Vehicles	6,325	185.5
Average Delay per Vehicle [s]	All Vehicles	106	3.1
VHD/VMT [min/mile]	All Vehicles	0.41	0.01
Number of Vehicles Served	HOV	34,742	49
Travel Distance [mi]	HOV	159,556	600
Travel Time [h]	HOV	3,611	32
Average Speed [mph]	HOV	44.2	0.4
Total Delay [h]	HOV	885	29
Average Delay per Vehicle [s]	HOV	90	3
VHD/VMT [min/mile]	HOV	0.33	0.01
Number of Vehicles Served	Truck	7,619	19
Travel Distance [mi]	Truck	42,426	480
Travel Time [h]	Truck	987	16
Average Speed [mph]	Truck	43.0	1
Total Delay [h]	Truck	264	13
Average Delay per Vehicle [s]	Truck	121	6
VHD/VMT [min/mile]	Truck	0.37	0.02

Performance Measure	Vehicle Types		
	HOV	Truck	All
Vehicles Served	34,740	7,620	208,800
Demand Volume	35,960	8,270	211,350
Percent Demand Served	96.6%	92.1%	98.8%
Vehicle Miles of Travel	159,560	42,430	917,290
Person Miles of Travel	335,070	44,550	1,094,920
Vehicle Hours of Travel	3,610	990	22,140
Vehicle Hours of Delay	890	260	6,330
VHD % of VHT	24.7%	26.3%	28.6%
Average Delay per Vehicle (min)	1.54	2.05	1.82
Person Hours of Delay	1,870	270	7,320
Average Travel Speed	44.2	43.0	41.4

VISSIM Post-Processor
Average Values from 10 Runs
Peak Hour Travel Time

SR 65 Widening
Design Year - No Build
AM Peak Period

Mode	Description	Distance (ft)	Volume (vehicles)		Travel Time (min.:sec.)		Speed (mph)
			Average	Std. Dev.	Average	Std. Dev.	Average
SOV	SR-65 at Blue Oaks to I-80 at Antelope	43,094	579	11	09:41	00:17	20.2
	I-80 at Auburn to SR-65 at Blue Oaks	32,831	1661	16	06:29	00:04	23.0
	I-80: Sierra College to Antelope	45,844	1227	15	08:22	00:03	24.9
	I-80: Auburn to Sierra College	36,738	805	13	06:41	00:02	25.0
	SR-65: I-80 to Sunset	43,104	1259	19	04:16	00:04	45.8
	SR-65: Sunset to Ferrari Ranch	45,833	402	7	03:31	00:00	59.3
	SR-65: Ferrari Ranch to Sunset	36,734	1292	15	03:36	00:05	46.4
	SR-65: Sunset to I-80	32,846	1663	16	07:35	00:52	19.7
HOV	SR-65 at Blue Oaks to I-80 at Antelope	43,094	240	8	09:37	00:17	45.8
	I-80 at Auburn to SR-65 at Blue Oaks	32,831	266	8	06:15	00:02	59.3
	I-80: Sierra College to Antelope	45,844	411	8	08:16	00:02	46.4
	I-80: Auburn to Sierra College	36,738	156	5	06:32	00:02	19.7
	SR-65: I-80 to Sunset	43,104	78	4	04:11	00:03	20.4
	SR-65: Sunset to Ferrari Ranch	45,833	51	3	03:31	00:01	23.9
	SR-65: Ferrari Ranch to Sunset	36,734	197	7	03:36	00:05	25.2
	SR-65: Sunset to I-80	32,846	441	11	07:26	00:55	25.5

VISSIM Post-Processor
Average Values from 10 Runs
Network Statistics

SR 65 Widening
Design Year - No Build
PM Peak Period

Network Performance	Vehicle Types	Average	Std. Dev.
Number of Vehicles Served	All Vehicles	302,584	315
Travel Distance [mi]	All Vehicles	1,106,394	1,394
Travel Time [h]	All Vehicles	32,921	479.3
Average Speed [mph]	All Vehicles	33.6	0.5
Total Delay [h]	All Vehicles	13,378	475.7
Average Delay per Vehicle [s]	All Vehicles	156	5.6
VHD/VMT [min/mile]	All Vehicles	0.73	0.03
Number of Vehicles Served	HOV	52,957	168
Travel Distance [mi]	HOV	200,204	642
Travel Time [h]	HOV	5,368	56
Average Speed [mph]	HOV	37.3	0.4
Total Delay [h]	HOV	1,860	51
Average Delay per Vehicle [s]	HOV	124	3
VHD/VMT [min/mile]	HOV	0.56	0.02
Number of Vehicles Served	Truck	8,062	29
Travel Distance [mi]	Truck	38,340	320
Travel Time [h]	Truck	1,085	30
Average Speed [mph]	Truck	35.4	1
Total Delay [h]	Truck	422	26
Average Delay per Vehicle [s]	Truck	184	11
VHD/VMT [min/mile]	Truck	0.66	0.04

Performance Measure	Vehicle Types		
	HOV	Truck	All
Vehicles Served	52,960	8,060	302,580
Demand Volume	54,620	8,720	305,210
Percent Demand Served	97.0%	92.4%	99.1%
Vehicle Miles of Travel	200,200	38,340	1,106,390
Person Miles of Travel	420,430	40,260	1,328,540
Vehicle Hours of Travel	5,370	1,080	32,920
Vehicle Hours of Delay	1,860	420	13,380
VHD % of VHT	34.6%	38.9%	40.6%
Average Delay per Vehicle (min)	2.11	3.13	2.65
Person Hours of Delay	3,910	440	15,450
Average Travel Speed	37.3	35.4	33.6

VISSIM Post-Processor
Average Values from 10 Runs
Peak Hour Travel Time

SR 65 Widening
Design Year - No Build
PM Peak Period

Mode	Description	Distance (ft)	Volume (vehicles)		Travel Time (min.:sec.)		Speed (mph)
			Average	Std. Dev.	Average	Std. Dev.	Average
SOV	SR-65 at Blue Oaks to I-80 at Antelope	43,094	844	16	09:18	00:45	21.0
	I-80 at Auburn to SR-65 at Blue Oaks	32,825	1,511	13	11:47	01:43	12.7
	I-80: Sierra College to Antelope	45,844	636	9	08:21	00:02	25.0
	I-80: Auburn to Sierra College	36,738	908	14	07:19	00:37	22.8
	SR-65: I-80 to Sunset	43,104	1,590	26	07:34	00:44	25.9
	SR-65: Sunset to Ferrari Ranch	45,833	463	11	03:33	00:01	58.8
	SR-65: Ferrari Ranch to Sunset	36,734	798	12	03:30	00:00	47.6
	SR-65: Sunset to I-80	32,840	1,256	15	05:15	01:10	28.4
HOV	SR-65 at Blue Oaks to I-80 at Antelope	43,094	126	5	09:11	00:42	25.9
	I-80 at Auburn to SR-65 at Blue Oaks	32,825	451	10	06:34	00:07	58.8
	I-80: Sierra College to Antelope	45,844	202	6	08:14	00:03	47.6
	I-80: Auburn to Sierra College	36,738	320	8	06:44	00:09	28.4
	SR-65: I-80 to Sunset	43,104	52	4	06:02	00:40	21.3
	SR-65: Sunset to Ferrari Ranch	45,833	102	5	03:32	00:01	22.7
	SR-65: Ferrari Ranch to Sunset	36,734	175	7	03:31	00:01	25.3
	SR-65: Sunset to I-80	32,840	247	7	05:13	01:11	24.8

VISSIM Post-Processor
Average Results from 10 Runs
Freeway Operations Summary

SR 65 Widening
Design Year - No Build
AM Peak Hour

Location	Facility Type	Mainline Volume (vph)			On-ramp Volume (vph)			Off-ramp Volume (vph)			Speed (mph)		Density (vplpm)		LOS		
		Avg.	St. Dev.	%	Avg.	St. Dev.	%	Avg.	St. Dev.	%	Avg.	St. Dev.	Avg.	St. Dev.			
1 I-80 EB - Auburn Blvd On-ramp	Merge	7,466	44	110.3%	1,238	24	110.5%				60.8	1.5	33.5	1.1	D		
2 I-80 EB - Auburn Blvd to Douglas Blvd	Basic	8,698	74	110.2%							52.9	4.2	42.0	4.1	E		
3 I-80 EB - Douglas Blvd EB Off-ramp	Diverge	8,690	91	110.1%				1,382	48	108.0%	59.1	3.7	31.3	3.3	D		
4 I-80 EB - Douglas Blvd WB Off-ramp	Diverge	7,307	101	110.5%				385	36	113.3%	62.0	1.0	25.6	1.1	C		
5 I-80 EB - Douglas Blvd Off to On-ramp	Basic	6,919	111	110.3%							62.6	0.4	27.8	0.4	D		
6 I-80 EB - Douglas Blvd to Eureka Rd	Weave	6,918	118	110.3%	1,134	26	94.5%	1,841	81	105.2%	62.4	0.2	26.6	0.3	C		
7 I-80 EB CD - Eureka Rd to Taylor Rd/SR-65	Weave	644	48	109.1%	1,220	69	105.2%	925	52	105.1%	61.9	1.1	15.2	1.0	B		
8 I-80 EB - Eureka Rd to SR-65	Basic	6,215	106	108.7%							61.9	0.3	29.2	0.5	D		
9 I-80 EB - HOV Connector Off-ramp	Diverge	6,215	101	108.6%				534	41	106.8%	59.0	1.5	29.7	1.2	D		
10 I-80 EB - SR-65 Off-ramp	Diverge	5,678	113	108.8%				3,231	94	108.1%	62.9	0.6	23.9	0.5	C		
11 I-80 EB - SR-65 Off-ramp to Eureka Rd On-ramp	Basic	2,446	68	109.7%							63.9	0.2	14.7	0.5	B		
17 I-80 EB - Eureka Rd On-ramp	Merge	2,450	68	109.9%	619	43	104.9%				62.6	0.6	15.5	0.6	B		
18 I-80 EB - Eureka Rd On-ramp to SR-65 On-ramp	Basic	3,070	88	108.9%							63.7	0.2	16.9	0.6	B		
19 I-80 EB - SR-65 On-ramp	Merge	3,069	90	108.8%	1,841	76	104.0%				61.2	0.3	26.3	0.5	C		
20 I-80 EB - SR-65 to Rocklin Rd	Basic	4,910	116	107.0%							63.1	0.2	24.0	0.5	C		
22 I-80 EB - Rocklin Rd Off-ramp	Diverge	4,918	101	107.1%				1,749	73	108.0%	63.4	0.1	22.9	0.3	C		
23 I-80 EB - Rocklin Rd Off to On-ramp	Basic	3,182	105	107.1%							63.6	0.2	20.2	0.5	C		
24 I-80 EB - Rocklin Rd On-ramp	Merge	3,185	101	107.2%	249	5	99.6%				60.1	0.7	20.6	0.6	C		
25 I-80 EB - Rocklin Rd to Sierra College Blvd	Basic	3,440	106	106.8%							63.2	0.3	21.3	0.6	C		
26 I-80 EB - Sierra College Blvd Off-ramp	Diverge	3,442	107	106.9%				624	46	107.5%	62.2	0.7	22.6	0.6	C		
27 I-80 EB - Sierra College Blvd Off to On-ramp	Basic	2,823	91	106.9%							63.4	0.3	18.6	0.6	C		
28 I-80 EB - Sierra College Blvd SB On-ramp	Merge	2,825	88	107.0%	139	6	92.7%				62.7	0.2	17.3	0.6	B		
29 I-80 EB - Sierra College Blvd NB On-ramp	Merge	2,966	91	106.3%	489	22	101.8%				61.9	0.4	19.3	0.6	B		
38 I-80 WB - Sierra College Blvd Off-ramp	Diverge	5,377	22	105.8%						1,116	57	107.3%	52.8	2.1	32.5	1.2	D
39 I-80 WB - Sierra College Blvd Off to On-ramp	Basic	4,258	68	105.4%							61.1	0.7	26.0	0.2	C		
40 I-80 WB - Sierra College Blvd NB On-ramp	Merge	4,258	70	105.4%	50	3	82.8%				62.9	0.2	22.9	0.5	C		
41 I-80 WB - Sierra College Blvd SB On-ramp	Merge	4,307	83	105.0%	320	14	103.1%				60.8	1.3	24.8	1.0	C		
42 I-80 WB - Sierra College Blvd to Rocklin Rd	Basic	4,619	86	104.7%							62.2	0.4	27.4	0.5	D		
43 I-80 WB - Rocklin Rd Off-ramp	Diverge	4,618	82	104.7%				297	33	102.4%	60.8	0.5	28.1	0.6	D		
44 I-80 WB - Rocklin Rd Off to On-ramp	Basic	4,316	90	104.8%							63.0	0.2	25.6	0.4	C		
45 I-80 WB - Rocklin Rd On-ramp	Merge	4,316	91	104.7%	967	50	99.7%				60.5	1.0	27.0	0.8	C		
46 I-80 WB - Rocklin Rd to HOV Lane Start	Basic	5,273	118	103.6%							60.9	0.8	30.0	0.8	D		
47 I-80 WB - HOV Lane Start to SR-65	Basic	5,270	124	103.5%							62.1	0.5	24.4	0.7	C		
48 I-80 WB - SR-65 Off-ramp	Diverge	5,269	126	103.5%				1,608	97	103.1%	63.4	0.3	22.5	0.8	C		
49 I-80 WB - SR-65 Off to On-ramp	Basic	3,654	121	103.5%							63.6	0.1	20.3	0.8	C		
60 I-80 WB - SR-65 to Atlantic St	Weave	3,650	126	103.4%	5,275	135	100.5%	477	45	101.5%	58.8	0.8	24.8	0.6	C		
62 I-80 WB - Atlantic St EB Off-ramp	Diverge	8,403	162	101.1%				1,237	65	100.6%	57.2	4.6	31.2	3.0	D		
63 I-80 WB - Atlantic St EB Off to On-ramp	Basic	7,164	166	101.2%							62.2	0.5	27.3	0.4	D		
64 I-80 WB - Atlantic St On-ramp	Merge	7,161	159	101.1%	903	31	105.0%				57.6	2.1	38.1	1.3	E		
65 I-80 WB - Douglas Blvd Off-ramp	Diverge	8,058	142	101.5%				1,075	62	96.0%	59.0	2.8	33.6	1.8	D		
66 I-80 WB - Douglas Blvd Off to On-ramp	Basic	6,982	147	102.4%							62.7	0.7	28.0	0.5	D		
67 I-80 WB - Douglas Blvd WB On-ramp	Merge	6,985	143	102.4%	937	49	105.3%				59.5	2.5	30.2	1.8	D		
68 I-80 WB - Douglas Blvd EB On-ramp	Merge	7,921	141	102.7%	459	40	109.3%				59.3	1.5	35.2	1.3	E		
69 I-80 WB - Douglas Blvd to Riverside Ave	Basic	8,381	130	103.1%							61.6	0.5	33.8	0.6	D		
70 I-80 WB - Riverside Ave Off-ramp	Diverge	8,383	140	103.1%				1,040	73	98.1%	62.1	0.6	34.4	0.7	D		
71 I-80 WB - Riverside Ave Off to On-ramp	Basic	7,341	150	103.8%							62.6	0.3	29.4	0.5	D		
72 I-80 WB - Riverside Ave NB On-ramp	Merge	7,342	153	103.8%	213	6	85.2%				63.0	0.2	27.2	0.9	C		
73 I-80 WB - Riverside Ave SB On-ramp	Merge	7,553	155	103.2%	778	14	94.8%				62.6	0.2	32.7	1.1	D		
74 I-80 WB - Riverside Ave to Antelope Rd	Basic	8,344	150	102.5%							61.4	0.3	33.7	0.8	D		
75 I-80 WB - Antelope Rd Off-ramp	Diverge	8,354	146	102.6%				464	29	89.1%	57.0	5.3	37.0	3.4	E		
76 I-80 WB - Antelope Rd Off to On-ramp	Basic	7,932	128	104.1%							47.1	13.0	45.9	14.7	F		
77 I-80 WB - Antelope Rd WB On-ramp	Merge	7,955	143	104.4%	521	14	98.2%				34.5	11.2	70.2	21.2	F		
78 I-80 WB - Antelope Rd to Truck Scales	Weave	8,530	189	104.7%	444	13	88.9%	91	17	82.4%	32.7	7.3	70.3	11.7	F		
79 I-80 WB - Truck Scales Off to On-ramp	Basic	9,026	193	105.7%							31.7	2.8	77.8	7.4	F		
80 I-80 WB - Truck Scales On-ramp	Merge	9,075	231	106.3%	92	15	83.5%				31.2	1.1	86.6	3.4	F		
81 I-80 WB - Truck Scales to Elkhorn Blvd	Basic	9,248	227	106.9%							39.2	1.5	59.5	2.2	F		
82 I-80 WB - Elkhorn Blvd Off-ramp	Diverge	9,256	224	107.0%				1,087	63	105.5%	52.5	6.3	36.6	4.6	E		
83 I-80 WB - Elkhorn Blvd Off to On-ramp	Basic	8,207	213	107.7%							46.6	16.7	54.0	26.6	F		
84 I-80 WB - Elkhorn Blvd WB On-ramp	Merge	8,232	220	108.0%	742	11	93.9%				42.9	16.8	60.9	29.8	F		
85 I-80 WB - Elkhorn Blvd EB On-ramp	Merge	9,008	254	107.1%	810	18	98.8%				45.1	14.2	57.5	19.7	F		

Notes: Average density reported for the analysis area only: for example, within the ramp influence area and not including the HOV lane.
Mainline volume is the upstream served volume for all lanes.

	Location	Facility Type	Mainline Volume (vph)			On-ramp Volume (vph)			Off-ramp Volume (vph)			Speed (mph)		Density (vplpm)		LOS
			Avg.	St. Dev.	%	Avg.	St. Dev.	%	Avg.	St. Dev.	%	Avg.	St. Dev.	Avg.	St. Dev.	
100	SR-65 NB - EB I-80 Connector	Basic	3,231	95	108.1%							62.5	0.3	28.0	1.0	D
101	SR-65 NB - Eureka Rd On-ramp	Merge	3,230	95	108.0%	941	58	105.7%				48.8	0.2	31.2	0.9	D
102	SR-65 NB - WB I-80 Connector	Basic	1,609	91	103.2%							53.1	0.3	17.6	0.9	B
103	SR-65 NB - I-80 to Stanford Ranch Rd	Weave	4,164	94	107.3%	2,142	93	104.0%	1,074	64	104.3%	59.9	0.4	25.8	0.8	C
106	SR-65 NB - Stanford Ranch Rd Off to On-ramp	Basic	5,235	109	106.6%							58.8	8.0	29.1	6.1	D
107	SR-65 NB - Stanford Ranch Rd On-ramp	Merge	5,240	110	106.7%	519	26	98.0%				51.2	7.4	40.1	6.2	E
109	SR-65 NB - Pleasant Grove Blvd Off-ramp	Diverge	5,762	128	105.9%				1,141	59	100.1%	55.5	2.9	39.5	3.3	E
110	SR-65 NB - Pleasant Grove Blvd Off to On-ramp	Basic	4,623	112	107.5%							61.8	1.9	30.0	1.2	D
111	SR-65 NB - Pleasant Grove Blvd to Blue Oaks Blvd	Weave	4,625	117	107.6%	278	29	95.7%	1,821	85	110.4%	63.1	0.3	23.1	0.5	C
114	SR-65 NB - Blue Oaks Blvd Off to On-ramp	Basic	3,078	111	104.7%							63.9	0.2	17.2	0.7	B
115	SR-65 NB - Blue Oaks Blvd On-ramp	Merge	3,078	111	104.7%	483	31	100.7%				62.2	0.3	19.4	0.7	B
116	SR-65 NB - Blue Oaks Blvd to Sunset Blvd	Basic	3,562	133	104.1%							63.1	0.3	20.9	0.8	C
118	SR-65 NB - Sunset Blvd Off-ramp	Diverge	3,563	135	104.2%				1,168	58	104.3%	63.8	0.2	18.7	0.6	B
119	SR-65 NB - Sunset Blvd Off to On-ramp	Basic	2,397	96	104.2%							64.0	0.2	13.8	0.7	B
120	SR-65 NB - Sunset Blvd EB On-ramp	Merge	2,398	91	104.3%	161	20	94.4%				63.4	0.3	13.9	0.6	B
121	SR-65 NB - Sunset Blvd to Whitney Ranch Pkwy	Weave	2,559	83	103.6%	456	19	108.6%	680	43	93.1%	63.7	0.2	13.7	0.4	B
124	SR-65 NB - Whitney Ranch Pkwy Off to On-ramp	Basic	2,335	76	108.1%							64.0	0.1	13.6	0.4	B
125	SR-65 NB - Whitney Ranch Pkwy EB On-ramp	Merge	2,337	79	108.2%	497	26	105.8%				62.1	0.3	16.3	0.4	B
126	SR-65 NB - Whitney Ranch Pkwy WB On-ramp	Merge	2,834	84	107.8%	465	26	110.8%				63.4	0.1	18.6	0.4	B
127	SR-65 NB - Whitney Ranch Pkwy to Twelve Bridges Dr	Basic	3,298	91	108.1%							63.5	0.1	19.1	0.5	C
128	SR-65 NB - Twelve Bridges Dr Off-ramp	Diverge	3,300	89	108.2%				701	50	96.1%	62.7	0.4	23.1	0.8	C
129	SR-65 NB - Twelve Bridges Dr Off to On-ramp	Basic	2,602	84	112.1%							63.7	0.3	15.8	0.3	B
130	SR-65 NB - Twelve Bridges Dr to Lincoln Blvd	Weave	2,602	87	112.2%	942	53	107.0%	824	58	114.5%	63.3	0.2	17.2	0.4	B
133	SR-65 NB - Lincoln Blvd to Ferrari Ranch Rd	Basic	2,720	83	109.7%							63.1	0.4	21.6	0.6	C
134	SR-65 NB - Ferrari Ranch Rd Off-ramp	Diverge	2,721	83	109.7%				1,186	51	104.9%	63.6	0.2	18.5	0.5	B
135	SR-65 NB - Ferrari Ranch Rd Off to On-ramp	Basic	1,540	78	114.1%							64.1	0.2	14.6	0.5	B
136	SR-65 NB - Ferrari Ranch Rd On-ramp	Merge	1,542	76	114.2%	181	5	106.2%				61.8	0.6	15.3	0.5	B
150	SR-65 SB - Ferrari Ranch Rd Off-ramp	Diverge	2,183	40	112.5%				146	23	104.3%	62.9	0.3	27.3	0.5	C
151	SR-65 SB - Ferrari Ranch Rd Off to On-ramp	Basic	2,035	48	113.1%							63.0	0.2	25.7	0.7	C
152	SR-65 SB - Ferrari Ranch Rd WB On-ramp	Merge	2,036	48	113.1%	1,023	22	106.6%				61.1	0.2	24.9	0.5	C
153	SR-65 SB - Ferrari Ranch Rd EB On-ramp	Merge	3,057	55	110.8%	1,020	25	93.5%				58.3	2.3	28.5	1.3	D
154	SR-65 SB - Ferrari Ranch Rd to Lincoln Blvd	Basic	4,081	64	106.0%							62.9	0.1	30.0	0.5	D
156	SR-65 SB - Lincoln Blvd to Twelve Bridges Dr	Weave	4,081	63	106.0%	887	67	108.2%	1,012	60	108.8%	59.5	1.3	28.1	0.8	D
159	SR-65 SB - Twelve Bridges Dr Off to On-ramp	Basic	3,953	97	105.7%							62.7	0.5	26.1	0.4	D
160	SR-65 SB - Twelve Bridges Dr On-ramp	Merge	3,953	96	105.7%	639	32	116.2%				60.7	1.6	29.2	1.0	D
161	SR-65 SB - Twelve Bridges Dr to Placer Pkwy	Basic	4,594	121	107.1%							62.4	0.2	29.6	0.5	D
162	SR-65 SB - Placer Pkwy Off-ramp	Diverge	4,592	116	107.0%				841	57	109.2%	61.2	1.7	29.1	0.6	D
163	SR-65 SB - Placer Pkwy Off to On-ramp	Basic	3,750	104	106.5%							62.4	0.5	23.3	0.7	C
164	SR-65 SB - Placer Pkwy WB On-ramp	Merge	3,750	102	106.5%	332	28	103.8%				62.4	0.6	25.4	0.6	C
165	SR-65 SB - Placer Pkwy to Sunset Blvd	Weave	4,079	101	106.2%	641	30	112.5%	853	52	106.6%	61.7	0.2	23.9	0.4	C
168	SR-65 SB - Sunset Blvd Off to On-ramp	Basic	3,862	90	107.0%							47.4	22.5	38.6	34.5	E
169	SR-65 SB - Sunset Blvd WB On-ramp	Merge	3,852	102	106.7%	114	16	103.7%				33.6	23.6	74.0	53.9	F
170	SR-65 SB - Sunset Blvd EB On-ramp	Merge	3,923	143	105.5%	349	15	97.0%				19.6	15.3	97.0	29.9	F
171	SR-65 SB - Sunset Blvd to Blue Oaks Blvd	Basic	4,188	179	102.6%							16.5	8.6	101.7	22.2	F
172	SR-65 SB - Blue Oaks Blvd Off-ramp	Diverge	4,168	174	102.1%				601	63	103.6%	15.3	2.5	97.3	8.6	F
173	SR-65 SB - Blue Oaks Blvd Off-ramp to Lane Drop	Basic	3,494	137	99.8%							14.1	1.4	113.7	4.7	F
174	SR-65 SB - Lane Drop to Blue Oaks Blvd WB On-ramp	Basic	3,469	149	99.1%							14.4	1.5	113.9	5.4	F
175	SR-65 SB - Blue Oaks Blvd WB On-ramp	Merge	3,461	150	98.9%	390	15	100.1%				15.7	1.9	106.9	5.7	F
176	SR-65 SB - Blue Oaks Blvd to Pleasant Grove Blvd	Weave	3,803	172	97.8%	1,272	75	102.6%	599	51	98.3%	24.3	3.0	79.1	6.1	F
178	SR-65 SB - Pleasant Grove Blvd Off to On-ramp	Basic	4,426	126	97.9%							30.2	3.4	73.7	5.6	F
179	SR-65 SB - Pleasant Grove Blvd WB On-ramp	Merge	4,420	127	97.8%	1,081	36	102.0%				24.8	2.3	78.8	4.7	F
180	SR-65 SB - Pleasant Grove Blvd EB On-ramp	Merge	5,464	106	97.9%	857	51	103.2%				28.1	0.6	81.6	2.3	F
181	SR-65 SB - Pleasant Grove Blvd to Galleria Blvd	Basic	6,288	110	98.1%							55.7	1.3	36.9	1.3	E
182	SR-65 SB - Galleria Blvd Off-ramp	Diverge	6,288	109	98.1%				1,074	58	92.6%	60.0	0.6	34.2	0.9	D
183	SR-65 SB - Galleria Blvd Off to On-ramp	Basic	5,218	121	99.4%							62.3	0.3	28.3	0.7	D
184	SR-65 SB - Galleria Blvd to I-80	Weave	5,220	105	99.4%	1,120	53	101.8%	4,511	130	98.5%	61.6	0.9	24.4	0.4	C
187	SR-65 SB - EB I-80 Connector	Basic	1,833	77	103.6%							52.5	0.8	25.4	1.1	C
188	SR-65 SB - WB I-80 Connector	Basic	3,674	106	94.9%							54.7	0.5	23.6	0.6	C

Notes: Average density reported for the analysis area only: for example, within the ramp influence area and not including the HOV lane.
 Mainline volume is the upstream served volume for all lanes.

VISSIM Post-Processor
 Average Results from 10 Runs
 Freeway Operations Summary

SR 65 Widening
 Design Year - No Build
 PM Peak Hour

Location	Facility Type	Mainline Volume (vph)			On-ramp Volume (vph)			Off-ramp Volume (vph)			Speed (mph)		Density (vplpm)		LOS
		Avg.	St. Dev.	%	Avg.	St. Dev.	%	Avg.	St. Dev.	%	Avg.	St. Dev.	Avg.	St. Dev.	
1 I-80 EB - Auburn Blvd On-ramp	Merge	8,054	46	102.0%	995	18	101.6%				61.5	1.2	29.9	0.8	D
2 I-80 EB - Auburn Blvd to Douglas Blvd	Basic	9,038	74	101.8%							58.8	5.4	35.1	4.6	E
3 I-80 EB - Douglas Blvd EB Off-ramp	Diverge	9,021	108	101.6%				1,141	76	99.2%	53.7	8.0	41.8	16.6	E
4 I-80 EB - Douglas Blvd WB Off-ramp	Diverge	7,858	118	101.7%				388	46	97.0%	62.3	0.6	26.1	0.7	C
5 I-80 EB - Douglas Blvd Off to On-ramp	Basic	7,470	120	101.9%							61.3	4.7	27.2	3.1	D
6 I-80 EB - Douglas Blvd to Eureka Rd	Weave	7,463	138	101.8%	1,722	47	91.6%	1,770	88	101.2%	52.5	14.1	41.5	23.0	E
7 I-80 EB CD - Eureka Rd to Taylor Rd/SR-65	Weave	1,148	61	103.4%	1,417	74	93.2%	1,424	78	98.9%	19.7	15.9	87.9	29.6	F
8 I-80 EB - Eureka Rd to SR-65	Basic	7,306	186	97.9%							40.4	18.3	65.0	33.5	F
9 I-80 EB - HOV Connector Off-ramp	Diverge	7,272	197	97.5%				978	52	96.8%	36.2	12.3	61.8	20.5	F
10 I-80 EB - SR-65 Off-ramp	Diverge	6,261	220	97.1%				3,506	140	97.7%	61.3	10.5	57.8	17.6	F
11 I-80 EB - SR-65 Off-ramp to Eureka Rd On-ramp	Basic	2,724	141	95.2%							63.6	0.2	17.0	0.7	B
17 I-80 EB - Eureka Rd On-ramp	Merge	2,720	142	95.1%	740	52	98.7%				62.5	0.7	15.3	0.6	B
18 I-80 EB - Eureka Rd On-ramp to SR-65 On-ramp	Basic	3,456	145	95.7%							63.8	0.2	17.1	0.4	B
19 I-80 EB - SR-65 On-ramp	Merge	3,456	148	95.7%	2,485	135	95.9%				60.1	0.8	28.2	0.8	D
20 I-80 EB - SR-65 to Rocklin Rd	Basic	5,940	198	95.8%							62.6	0.4	26.2	0.8	D
22 I-80 EB - Rocklin Rd Off-ramp	Diverge	5,934	199	95.7%				1,634	88	96.7%	63.2	0.1	25.2	0.7	C
23 I-80 EB - Rocklin Rd Off to On-ramp	Basic	4,290	166	95.1%							63.2	0.2	25.0	1.0	C
24 I-80 EB - Rocklin Rd On-ramp	Merge	4,285	175	95.0%	267	26	102.5%				59.0	1.5	25.3	1.6	C
25 I-80 EB - Rocklin Rd to Sierra College Blvd	Basic	4,548	166	95.4%							62.9	0.3	25.8	1.1	C
26 I-80 EB - Sierra College Blvd Off-ramp	Diverge	4,549	169	95.4%				553	57	86.3%	60.2	2.1	27.6	1.9	C
27 I-80 EB - Sierra College Blvd Off to On-ramp	Basic	3,995	140	96.7%							63.3	0.2	22.6	0.5	C
28 I-80 EB - Sierra College Blvd SB On-ramp	Merge	3,993	139	96.7%	325	8	95.4%				59.8	1.0	21.7	1.0	C
29 I-80 EB - Sierra College Blvd NB On-ramp	Merge	4,315	144	96.5%	889	20	102.1%				59.2	0.7	26.8	1.0	C
38 I-80 WB - Sierra College Blvd Off-ramp	Diverge	4,075	25	105.9%				764	45	104.7%	59.9	0.6	22.0	0.4	C
39 I-80 WB - Sierra College Blvd Off to On-ramp	Basic	3,308	55	106.0%							63.1	0.5	20.4	0.6	C
40 I-80 WB - Sierra College Blvd NB On-ramp	Merge	3,309	58	106.1%	386	10	101.6%				61.9	0.5	19.4	0.4	B
41 I-80 WB - Sierra College Blvd SB On-ramp	Merge	3,697	59	105.6%	385	10	101.3%				62.5	0.2	21.4	0.4	C
42 I-80 WB - Sierra College Blvd to Rocklin Rd	Basic	4,079	62	105.1%							62.9	0.2	23.7	0.6	C
43 I-80 WB - Rocklin Rd Off-ramp	Diverge	4,079	62	105.1%				312	41	107.7%	62.0	0.5	24.6	0.7	C
44 I-80 WB - Rocklin Rd Off to On-ramp	Basic	3,765	81	104.9%							63.3	0.1	22.0	0.6	C
45 I-80 WB - Rocklin Rd On-ramp	Merge	3,764	85	104.8%	1,559	73	103.9%				58.4	1.4	27.6	0.8	C
46 I-80 WB - Rocklin Rd to HOV Lane Start	Basic	5,317	123	104.4%							60.2	0.9	30.3	0.6	D
47 I-80 WB - HOV Lane Start to SR-65	Basic	5,307	125	104.3%							61.9	0.6	23.2	0.6	C
48 I-80 WB - SR-65 Off-ramp	Diverge	5,306	123	104.2%				2,066	88	102.8%	63.7	0.2	21.3	0.5	C
49 I-80 WB - SR-65 Off to On-ramp	Basic	3,240	97	105.2%							63.8	0.1	18.4	0.6	C
60 I-80 WB - SR-65 to Atlantic St	Weave	3,242	95	105.3%	4,970	100	99.2%	579	45	101.5%	59.3	1.6	23.7	1.2	C
62 I-80 WB - Atlantic St EB Off-ramp	Diverge	7,703	157	102.4%				1,094	55	98.6%	59.5	4.8	29.8	6.9	D
63 I-80 WB - Atlantic St EB Off to On-ramp	Basic	6,609	140	103.1%							62.7	0.4	25.3	0.7	C
64 I-80 WB - Atlantic St On-ramp	Merge	6,610	146	103.1%	1,253	54	98.6%				56.1	3.2	38.9	2.5	E
65 I-80 WB - Douglas Blvd Off-ramp	Diverge	7,861	157	102.4%				1,177	71	102.3%	60.9	0.7	31.6	0.9	D
66 I-80 WB - Douglas Blvd Off to On-ramp	Basic	6,684	140	102.4%							63.1	0.3	26.5	0.4	D
67 I-80 WB - Douglas Blvd WB On-ramp	Merge	6,684	143	102.4%	1,197	48	88.7%				57.8	2.4	28.8	1.5	D
68 I-80 WB - Douglas Blvd EB On-ramp	Merge	7,883	162	100.0%	726	43	99.5%				57.9	3.9	35.7	3.0	E
69 I-80 WB - Douglas Blvd to Riverside Ave	Basic	8,609	135	100.0%							61.2	0.5	33.3	0.7	D
70 I-80 WB - Riverside Ave Off-ramp	Diverge	8,613	156	100.0%				1,260	61	100.8%	61.5	1.5	34.8	1.4	D
71 I-80 WB - Riverside Ave Off to On-ramp	Basic	7,358	138	100.0%							62.6	0.4	27.8	0.4	D
72 I-80 WB - Riverside Ave NB On-ramp	Merge	7,356	136	99.9%	200	0	100.0%				62.6	0.2	31.6	0.7	D
73 I-80 WB - Riverside Ave SB On-ramp	Merge	7,551	133	99.9%	553	5	98.7%				59.2	2.2	34.4	0.8	D
74 I-80 WB - Riverside Ave to Antelope Rd	Basic	8,095	144	99.7%							60.7	1.1	32.0	1.1	D
75 I-80 WB - Antelope Rd Off-ramp	Diverge	8,095	141	99.7%				1,168	75	99.8%	62.1	0.6	32.9	0.5	D
76 I-80 WB - Antelope Rd Off to On-ramp	Basic	6,936	141	99.8%							63.0	0.4	26.9	0.5	D
77 I-80 WB - Antelope Rd WB On-ramp	Merge	6,935	140	99.8%	341	3	97.5%				61.1	0.7	24.8	0.5	C
78 I-80 WB - Antelope Rd to Truck Scales	Weave	7,278	139	99.7%	528	16	99.5%	76	14	69.1%	61.9	0.5	27.5	0.6	C
79 I-80 WB - Truck Scales Off to On-ramp	Basic	7,729	148	100.1%							62.8	0.1	28.8	0.3	D
80 I-80 WB - Truck Scales On-ramp	Merge	7,722	148	100.0%	77	18	70.0%				62.4	0.3	29.0	0.5	D
81 I-80 WB - Truck Scales to Elkhorn Blvd	Basic	7,797	157	99.6%							60.8	1.4	31.0	0.8	D
82 I-80 WB - Elkhorn Blvd Off-ramp	Diverge	7,794	157	99.5%				1,220	68	97.6%	61.3	0.9	28.2	0.5	D
83 I-80 WB - Elkhorn Blvd Off to On-ramp	Basic	6,579	130	100.0%							62.5	0.8	25.9	0.4	C
84 I-80 WB - Elkhorn Blvd WB On-ramp	Merge	6,580	133	100.0%	898	4	99.7%				56.2	1.6	28.0	1.2	C
85 I-80 WB - Elkhorn Blvd EB On-ramp	Merge	7,481	138	100.0%	582	8	100.3%				61.6	0.5	30.0	0.5	D

Notes: Average density reported for the analysis area only: for example, within the ramp influence area and not including the HOV lanes.
 Mainline volume is the upstream served volume for all lanes.

VISSIM Post-Processor
Average Results from 10 Runs
Freeway Operations Summary

SR 65 Widening
Design Year - No Build
PM Peak Hour

Location	Facility Type	Mainline Volume (vph)			On-ramp Volume (vph)			Off-ramp Volume (vph)			Speed (mph)		Density (vplpm)		LOS
		Avg.	St. Dev.	%	Avg.	St. Dev.	%	Avg.	St. Dev.	%	Avg.	St. Dev.	Avg.	St. Dev.	
100 SR-65 NB - EB I-80 Connector	Basic	3,494	143	97.3%							20.5	15.4	98.8	31.6	F
101 SR-65 NB - Eureka Rd On-ramp	Merge	3,481	148	97.0%	1,072	87	89.4%				16.7	11.1	108.0	27.6	F
102 SR-65 NB - WB I-80 Connector	Basic	2,066	90	102.8%							41.9	7.9	27.7	6.9	D
103 SR-65 NB - I-80 to Stanford Ranch Rd	Weave	4,468	236	93.3%	3,045	98	100.8%	1,572	104	92.5%	24.7	8.3	78.7	13.9	F
106 SR-65 NB - Stanford Ranch Rd Off to On-ramp	Basic	5,829	146	95.4%							24.1	1.9	109.9	14.1	F
107 SR-65 NB - Stanford Ranch Rd On-ramp	Merge	5,826	126	95.4%	960	53	97.0%				30.4	1.2	66.9	1.7	F
109 SR-65 NB - Pleasant Grove Blvd Off-ramp	Diverge	6,795	91	95.7%				1,964	69	96.3%	52.6	1.2	40.5	1.1	E
110 SR-65 NB - Pleasant Grove Blvd Off to On-ramp	Basic	4,830	89	95.5%							62.6	0.4	27.3	0.6	D
111 SR-65 NB - Pleasant Grove Blvd to Blue Oaks Blvd	Weave	4,830	90	95.4%	588	35	98.0%	1,953	69	96.7%	63.1	0.3	22.5	0.3	C
114 SR-65 NB - Blue Oaks Blvd Off to On-ramp	Basic	3,471	81	95.4%							63.6	0.2	19.1	0.4	C
115 SR-65 NB - Blue Oaks Blvd On-ramp	Merge	3,472	79	95.4%	428	44	89.1%				62.5	0.3	20.5	0.6	C
116 SR-65 NB - Blue Oaks Blvd to Sunset Blvd	Basic	3,894	113	94.5%							63.2	0.2	21.4	0.7	C
118 SR-65 NB - Sunset Blvd Off-ramp	Diverge	3,896	109	94.6%				695	49	97.8%	63.6	0.1	19.5	0.6	B
119 SR-65 NB - Sunset Blvd Off to On-ramp	Basic	3,202	106	93.9%							63.6	0.2	17.3	0.5	B
120 SR-65 NB - Sunset Blvd EB On-ramp	Merge	3,202	109	93.9%	455	37	101.2%				62.2	0.4	19.0	0.6	B
121 SR-65 NB - Sunset Blvd to Whitney Ranch Pkwy	Weave	3,660	117	94.8%	903	39	107.4%	1,058	60	97.9%	63.2	0.4	19.2	0.4	B
124 SR-65 NB - Whitney Ranch Pkwy Off to On-ramp	Basic	3,507	97	96.9%							63.6	0.1	18.8	0.3	C
125 SR-65 NB - Whitney Ranch Pkwy EB On-ramp	Merge	3,508	101	96.9%	296	22	98.5%				62.9	0.3	20.4	0.5	C
126 SR-65 NB - Whitney Ranch Pkwy WB On-ramp	Merge	3,803	95	97.0%	516	27	105.4%				63.0	0.2	22.5	0.4	C
127 SR-65 NB - Whitney Ranch Pkwy to Twelve Bridges Dr	Basic	4,317	102	97.9%							63.0	0.2	23.5	0.4	C
128 SR-65 NB - Twelve Bridges Dr Off-ramp	Diverge	4,318	106	97.9%				795	55	101.9%	61.0	3.2	27.7	1.8	C
129 SR-65 NB - Twelve Bridges Dr Off to On-ramp	Basic	3,519	89	96.9%							63.4	0.2	19.5	0.5	C
130 SR-65 NB - Twelve Bridges Dr to Lincoln Blvd	Weave	3,515	90	96.8%	1,056	50	96.0%	952	75	96.2%	62.8	0.2	20.4	0.6	C
133 SR-65 NB - Lincoln Blvd to Ferrari Ranch Rd	Basic	3,611	127	96.5%							62.4	0.4	26.1	0.9	D
134 SR-65 NB - Ferrari Ranch Rd Off-ramp	Diverge	3,612	127	96.6%				1,812	65	96.4%	63.2	0.2	21.9	0.9	C
135 SR-65 NB - Ferrari Ranch Rd Off to On-ramp	Basic	1,796	97	96.6%							64.1	0.2	14.5	0.8	B
136 SR-65 NB - Ferrari Ranch Rd On-ramp	Merge	1,799	95	96.7%	212	11	100.9%				62.0	0.5	15.2	0.7	B
150 SR-65 SB - Ferrari Ranch Rd Off-ramp	Diverge	2,063	48	99.7%				270	31	100.0%	63.6	0.5	18.5	0.3	B
151 SR-65 SB - Ferrari Ranch Rd Off to On-ramp	Basic	1,793	56	99.6%							63.9	0.3	15.8	0.4	B
152 SR-65 SB - Ferrari Ranch Rd WB On-ramp	Merge	1,793	52	99.6%	662	17	97.4%				61.9	0.3	15.5	0.3	B
153 SR-65 SB - Ferrari Ranch Rd EB On-ramp	Merge	2,456	57	99.0%	661	16	98.6%				61.5	0.2	16.1	0.3	B
154 SR-65 SB - Ferrari Ranch Rd to Lincoln Blvd	Basic	3,117	62	99.0%							63.9	0.1	17.9	0.4	B
156 SR-65 SB - Lincoln Blvd to Twelve Bridges Dr	Weave	3,121	63	99.1%	749	50	101.2%	895	52	100.6%	62.5	0.4	17.0	0.5	B
159 SR-65 SB - Twelve Bridges Dr Off to On-ramp	Basic	2,973	79	99.1%							63.8	0.1	16.4	0.4	B
160 SR-65 SB - Twelve Bridges Dr On-ramp	Merge	2,973	77	99.1%	567	40	96.2%				62.3	0.3	19.0	0.5	B
161 SR-65 SB - Twelve Bridges Dr to Placer Pkwy	Basic	3,544	77	98.7%							63.5	0.1	19.3	0.4	C
162 SR-65 SB - Placer Pkwy Off-ramp	Diverge	3,546	80	98.8%				1,032	54	98.3%	63.4	0.2	19.6	0.6	B
163 SR-65 SB - Placer Pkwy Off to On-ramp	Basic	2,512	81	98.9%							63.8	0.2	14.1	0.4	B
164 SR-65 SB - Placer Pkwy WB On-ramp	Merge	2,514	82	99.0%	392	35	103.0%				62.5	0.3	17.6	0.6	B
165 SR-65 SB - Placer Pkwy to Sunset Blvd	Weave	2,907	91	99.5%	730	55	100.1%	738	55	97.1%	63.2	0.2	16.6	0.4	B
168 SR-65 SB - Sunset Blvd Off to On-ramp	Basic	2,903	86	100.4%							63.9	0.2	16.1	0.4	B
169 SR-65 SB - Sunset Blvd WB On-ramp	Merge	2,904	88	100.5%	381	25	102.9%				63.3	0.2	17.7	0.5	B
170 SR-65 SB - Sunset Blvd EB On-ramp	Merge	3,285	85	100.8%	752	29	103.1%				62.1	1.0	25.4	0.7	C
171 SR-65 SB - Sunset Blvd to Blue Oaks Blvd	Basic	4,038	95	101.2%							59.2	8.5	28.5	6.6	D
172 SR-65 SB - Blue Oaks Blvd Off-ramp	Diverge	4,038	95	101.2%				706	44	99.5%	58.3	13.2	30.9	17.3	D
173 SR-65 SB - Blue Oaks Blvd Off-ramp to Lane Drop	Basic	3,340	101	101.8%							56.8	15.1	36.8	25.4	E
174 SR-65 SB - Lane Drop to Blue Oaks Blvd WB On-ramp	Basic	3,344	96	101.9%							50.7	19.7	42.9	30.0	E
175 SR-65 SB - Blue Oaks Blvd WB On-ramp	Merge	3,344	95	102.0%	374	41	95.8%				46.4	19.2	48.2	31.2	F
176 SR-65 SB - Blue Oaks Blvd to Pleasant Grove Blvd	Weave	3,726	112	101.5%	1,238	83	88.4%	560	53	96.6%	45.0	16.8	48.4	22.4	F
178 SR-65 SB - Pleasant Grove Blvd Off to On-ramp	Basic	4,407	123	98.2%							45.5	16.8	55.2	20.8	F
179 SR-65 SB - Pleasant Grove Blvd WB On-ramp	Merge	4,404	120	98.1%	822	46	100.3%				34.9	14.2	63.4	22.6	F
180 SR-65 SB - Pleasant Grove Blvd EB On-ramp	Merge	5,219	116	98.3%	1,123	88	94.4%				28.0	0.8	89.4	4.8	F
181 SR-65 SB - Pleasant Grove Blvd to Galleria Blvd	Basic	6,334	90	97.4%							57.5	0.9	36.5	0.7	E
182 SR-65 SB - Galleria Blvd Off-ramp	Diverge	6,334	90	97.4%				1,190	73	97.5%	60.9	0.6	34.2	0.5	D
183 SR-65 SB - Galleria Blvd Off to On-ramp	Basic	5,142	109	97.4%							62.2	0.2	29.1	0.7	D
184 SR-65 SB - Galleria Blvd to I-80	Weave	5,144	106	97.4%	1,655	41	103.5%	4,339	116	101.1%	59.9	2.8	26.0	2.2	C
187 SR-65 SB - EB I-80 Connector	Basic	2,479	117	95.7%							47.4	10.7	37.1	22.0	E
188 SR-65 SB - WB I-80 Connector	Basic	3,695	103	98.8%							54.6	0.3	23.5	0.6	C

Notes: Average density reported for the analysis area only: for example, within the ramp influence area and not including the HOV lane.
Mainline volume is the upstream served volume for all lanes.

VISSIM Post-Processor
Average Results from 10 Runs
Intersection Volume and Delay

SR 65 Widening
Design Year - No Build
AM Peak Hour

	Intersection	Control	Volume (vph)		Percent Served	Delay (sec/veh)		Level of Service
			Demand	Served		Average	Std. Dev.	
1	Lincoln Blvd/Sterling Pkwy	Signal	3,025	3,330	110.1%	15.3	1.0	B
2	SR-65 SB Ramps/Twelve Bridges Dr	Signal	2,280	2,494	109.4%	16.2	1.0	B
3	SR-65 NB Ramps/Twelve Bridges Dr	Signal	2,425	2,592	106.9%	28.7	6.2	C
4	SR-65 SB Ramps/Sunset Blvd	Signal	3,035	3,245	106.9%	16.5	5.4	B
5	SR-65 NB Ramps/Sunset Blvd	Signal	3,530	3,792	107.4%	13.6	5.3	B
6	SR-65 SB Ramps-Washington Blvd/Blue Oaks Blvd	Signal	5,325	5,504	103.4%	89.5	14.6	F
7	SR-65 NB Ramps/Blue Oaks Blvd	Signal	3,300	3,471	105.2%	16.5	25.9	B
8	SR-65 SB Ramps/Pleasant Grove Blvd	Signal	4,760	4,835	101.6%	16.9	8.7	B
9	SR-65 NB Ramps/Pleasant Grove Blvd	Signal	3,955	4,041	102.2%	14.4	0.6	B
10	Stanford Ranch Rd/Five Star Blvd	Signal	3,735	3,903	104.5%	26.3	2.2	C
11	SR-65 NB Ramps/Stanford Ranch Rd	Signal	3,950	4,102	103.9%	18.6	8.8	B
12	SR-65 SB Ramps/Galleria Blvd	Signal	3,800	3,806	100.2%	54.6	14.5	D
13	Galleria Blvd/Antelope Creek Dr	Signal	2,405	2,416	100.4%	8.4	1.1	A
14	Galleria Blvd/Roseville Pkwy	Signal	5,321	5,631	105.8%	40.7	1.5	D
15	Creekside Ridge Dr/Roseville Pkwy	Signal	3,465	3,637	105.0%	7.6	2.1	A
16	Taylor Rd/East Roseville Pkwy	Signal	4,945	5,266	106.5%	60.4	15.3	E
17	North Sunrise Ave/East Roseville Pkwy	Signal	4,865	5,182	106.5%	33.1	3.6	C
18	Wills Rd/Atlantic St	Signal	2,265	2,454	108.3%	18.8	4.6	B
19	I-80 WB Ramps/Atlantic St	Signal	3,805	4,009	105.4%	30.2	12.7	C
20	Taylor Rd-I-80 EB Ramps/Eureka Rd	Signal	5,440	5,669	104.2%	30.0	3.2	C
21	North Sunrise Ave/Eureka Rd	Signal	5,145	5,382	104.6%	40.7	4.6	D
22	Harding Blvd/Wills Rd	Signal	2,120	2,240	105.7%	14.5	2.2	B
23	Harding Blvd/Douglas Blvd	Signal	2,720	2,970	109.2%	25.6	4.1	C
24	I-80 WB Ramps/Douglas Blvd	Signal	3,880	4,128	106.4%	22.4	7.1	C

Network Summary	
Total Demand Volume (veh/hr)	89,496
Total Volume Served (veh/hr)	94,098
Percent Served	105.1%

- Notes: 1. Volume is measured for the entire peak hour.
2. Delay is measured for the peak 15 minutes in the peak hour.

VISSIM Post-Processor
Average Results from 10 Runs
Intersection Volume and Delay

SR 65 Widening
Design Year - No Build
AM Peak Hour

	Intersection	Control	Volume (vph)		Percent Served	Delay (sec/veh)		Level of Service
			Demand	Served		Average	Std. Dev.	
25	I-80 EB Ramps/Douglas Blvd	Signal	4,235	4,527	106.9%	28.5	10.0	C
26	North Sunrise Ave/Douglas Blvd	Signal	4,585	4,839	105.5%	43.0	9.8	D
27	Pacific St/Woodside Dr	Signal	2,300	2,548	110.8%	7.6	0.4	A
28	Pacific St/Sunset Blvd	Signal	3,580	3,968	110.8%	28.8	1.3	C
29	Granite Dr/Rocklin Rd	Signal	3,006	3,139	104.4%	26.1	1.7	C
30	I-80 WB Ramps/Rocklin Rd	Signal	3,105	3,247	104.6%	22.2	2.2	C
31	I-80 EB Ramps/Rocklin Rd	Signal	3,255	3,511	107.9%	40.7	11.4	D
32	Aguilar Rd/Rocklin Rd	Signal	2,310	2,516	108.9%	9.2	0.9	A
33	Lincoln Blvd/SR-65 NB Off-Ramp	Signal	2,720	3,006	110.5%	9.5	0.8	A
34	Lincoln Blvd/SR-65 SB On-Ramp	Signal	2,000	2,180	109.0%	17.4	3.3	B
35	SR-65 SB Ramps/Placer Pkwy	Signal	3,800	4,114	108.3%	18.8	3.8	B
36	SR-65 NB Ramps/Whitney Ranch Pkwy	Signal	3,545	3,714	104.8%	13.5	4.4	B
40	Galleria Blvd/Berry St	Signal	2,005	2,124	105.9%	9.9	1.3	A

Network Summary	
Total Demand Volume (veh/hr)	40,446
Total Volume Served (veh/hr)	43,432
Percent Served	107.4%

- Notes: 1. Volume is measured for the entire peak hour.
 2. Delay is measured for the peak 15 minutes in the peak hour.

VISSIM Post-Processor
Average Results from 10 Runs
Intersection Volume and Delay

SR 65 Widening
Design Year - No Build
PM Peak Hour

	Intersection	Control	Volume (vph)		Percent Served	Delay (sec/veh)		Level of Service
			Demand	Served		Average	Std. Dev.	
1	Lincoln Blvd/Sterling Pkwy	Signal	3,460	3,417	98.8%	20.4	0.8	C
2	SR-65 SB Ramps/Twelve Bridges Dr	Signal	2,305	2,302	99.9%	15.6	1.2	B
3	SR-65 NB Ramps/Twelve Bridges Dr	Signal	2,540	2,512	98.9%	21.6	1.7	C
4	SR-65 SB Ramps/Sunset Blvd	Signal	4,105	4,193	102.1%	16.6	7.6	B
5	SR-65 NB Ramps/Sunset Blvd	Signal	4,210	4,340	103.1%	13.9	1.3	B
6	SR-65 SB Ramps-Washington Blvd/Blue Oaks Blvd	Signal	7,075	6,500	91.9%	213.8	16.4	F
7	SR-65 NB Ramps/Blue Oaks Blvd	Signal	4,100	3,853	94.0%	94.3	48.8	F
8	SR-65 SB Ramps/Pleasant Grove Blvd	Signal	6,340	6,222	98.1%	29.5	28.0	C
9	SR-65 NB Ramps/Pleasant Grove Blvd	Signal	5,905	5,798	98.2%	12.9	0.8	B
10	Stanford Ranch Rd/Five Star Blvd	Signal	5,405	5,351	99.0%	85.0	18.7	F
11	SR-65 NB Ramps/Stanford Ranch Rd	Signal	6,115	6,022	98.5%	20.6	2.6	C
12	SR-65 SB Ramps/Galleria Blvd	Signal	5,930	5,924	99.9%	27.4	10.8	C
13	Galleria Blvd/Antelope Creek Dr	Signal	4,150	4,104	98.9%	27.9	2.4	C
14	Galleria Blvd/Roseville Pkwy	Signal	8,080	7,658	94.8%	92.5	21.0	F
15	Creekside Ridge Dr/Roseville Pkwy	Signal	4,685	4,388	93.7%	50.2	16.7	D
16	Taylor Rd/East Roseville Pkwy	Signal	6,855	6,554	95.6%	55.4	7.1	E
17	North Sunrise Ave/East Roseville Pkwy	Signal	6,345	6,369	100.4%	88.5	57.8	F
18	Wills Rd/Atlantic St	Signal	3,385	3,450	101.9%	30.4	8.5	C
19	I-80 WB Ramps/Atlantic St	Signal	4,900	4,909	100.2%	21.5	14.2	C
20	Taylor Rd-I-80 EB Ramps/Eureka Rd	Signal	6,575	6,473	98.5%	99.3	15.0	F
21	North Sunrise Ave/Eureka Rd	Signal	6,645	6,762	101.8%	104.2	22.9	F
22	Harding Blvd/Wills Rd	Signal	3,025	3,095	102.3%	18.5	2.2	B
23	Harding Blvd/Douglas Blvd	Signal	3,870	3,825	98.8%	68.9	7.9	E
24	I-80 WB Ramps/Douglas Blvd	Signal	4,675	4,525	96.8%	20.1	4.0	C

Network Summary	
Total Demand Volume (veh/hr)	120,680
Total Volume Served (veh/hr)	118,547
Percent Served	98.2%

- Notes: 1. Volume is measured for the entire peak hour.
2. Delay is measured for the peak 15 minutes in the peak hour.

VISSIM Post-Processor
Average Results from 10 Runs
Intersection Volume and Delay

SR 65 Widening
Design Year - No Build
PM Peak Hour

	Intersection	Control	Volume (vph)		Percent Served	Delay (sec/veh)		Level of Service
			Demand	Served		Average	Std. Dev.	
25	I-80 EB Ramps/Douglas Blvd	Signal	5,500	5,166	93.9%	39.0	26.0	D
26	North Sunrise Ave/Douglas Blvd	Signal	6,325	5,816	92.0%	238.5	8.7	F
27	Pacific St/Woodside Dr	Signal	3,510	3,526	100.5%	10.0	0.8	A
28	Pacific St/Sunset Blvd	Signal	5,485	5,516	100.6%	37.4	3.7	D
29	Granite Dr/Rocklin Rd	Signal	4,190	4,321	103.1%	101.4	9.3	F
30	I-80 WB Ramps/Rocklin Rd	Signal	3,955	4,061	102.7%	53.9	19.7	D
31	I-80 EB Ramps/Rocklin Rd	Signal	3,885	3,923	101.0%	21.4	3.9	C
32	Aguilar Rd/Rocklin Rd	Signal	3,025	3,075	101.6%	27.6	6.4	C
33	Lincoln Blvd/SR-65 NB Off-Ramp	Signal	2,930	2,894	98.8%	7.8	1.0	A
34	Lincoln Blvd/SR-65 SB On-Ramp	Signal	1,940	1,949	100.5%	14.8	1.6	B
35	SR-65 SB Ramps/Placer Pkwy	Signal	4,765	4,830	101.4%	24.4	2.6	C
36	SR-65 NB Ramps/Whitney Ranch Pkwy	Signal	4,270	4,277	100.2%	23.7	5.2	C
40	Galleria Blvd/Berry St	Signal	2,960	3,009	101.6%	10.8	1.2	B

Network Summary	
Total Demand Volume (veh/hr)	52,740
Total Volume Served (veh/hr)	52,364
Percent Served	99.3%

- Notes: 1. Volume is measured for the entire peak hour.
- 2. Delay is measured for the peak 15 minutes in the peak hour.

SR 65 Capacity and Operational Improvements

**Vissim Model Results – Construction Year
Alternative 1 (Carpool Lane)**

VISSIM Post-Processor
Average Values from 10 Runs
Network Statistics

SR 65 Widening
Construction Year - HOV Lane Alternative
AM Peak Period

Network Performance	Vehicle Types	Average	Std. Dev.
Number of Vehicles Served	All Vehicles	167,492	95
Travel Distance [mi]	All Vehicles	799,522	1,334
Travel Time [h]	All Vehicles	18,061	156.4
Average Speed [mph]	All Vehicles	44.3	0.4
Total Delay [h]	All Vehicles	4,351	150.8
Average Delay per Vehicle [s]	All Vehicles	91	3.1
VHD/VMT [min/mile]	All Vehicles	0.33	0.01
Number of Vehicles Served	HOV	32,238	42
Travel Distance [mi]	HOV	164,736	723
Travel Time [h]	HOV	3,525	28
Average Speed [mph]	HOV	46.7	0.4
Total Delay [h]	HOV	727	26
Average Delay per Vehicle [s]	HOV	79	3
VHD/VMT [min/mile]	HOV	0.26	0.01
Number of Vehicles Served	Truck	7,508	15
Travel Distance [mi]	Truck	38,847	354
Travel Time [h]	Truck	902	9
Average Speed [mph]	Truck	43.1	1
Total Delay [h]	Truck	231	10
Average Delay per Vehicle [s]	Truck	108	5
VHD/VMT [min/mile]	Truck	0.36	0.02

Performance Measure	Vehicle Types		
	HOV	Truck	All
Vehicles Served	32,240	7,510	167,490
Demand Volume	33,420	8,100	169,440
Percent Demand Served	96.5%	92.7%	98.8%
Vehicle Miles of Travel	164,740	38,850	799,520
Person Miles of Travel	345,950	40,790	982,670
Vehicle Hours of Travel	3,520	900	18,060
Vehicle Hours of Delay	730	230	4,350
VHD % of VHT	20.7%	25.6%	24.1%
Average Delay per Vehicle (min)	1.36	1.84	1.56
Person Hours of Delay	1,530	240	5,160
Average Travel Speed	46.7	43.1	44.3

VISSIM Post-Processor
Average Values from 10 Runs
Peak Hour Travel Time

SR 65 Widening
Construction Year - HOV Lane Alternative
AM Peak Period

Mode	Description	Distance (ft)	Volume (vehicles)		Travel Time (min.:sec.)		Speed (mph)
			Average	Std. Dev.	Average	Std. Dev.	Average
SOV	SR-65 at Blue Oaks to I-80 at Antelope	43,097	835	13	08:51	00:21	22.1
	I-80 at Auburn to SR-65 at Blue Oaks	30,585	1,593	16	06:41	00:05	20.8
	I-80: Sierra College to Antelope	45,827	1,130	12	08:38	00:15	24.1
	I-80: Auburn to Sierra College	36,777	684	11	06:38	00:02	25.2
	SR-65: I-80 to Sunset	43,107	653	12	04:17	00:00	45.8
	SR-65: Sunset to Ferrari Ranch	45,816	175	6	03:31	00:01	59.3
	SR-65: Ferrari Ranch to Sunset	36,773	1,045	11	03:44	00:06	44.8
	SR-65: Sunset to I-80	30,586	1,266	15	04:25	00:09	31.4
HOV	SR-65 at Blue Oaks to I-80 at Antelope	43,097	386	8	08:33	00:13	45.8
	I-80 at Auburn to SR-65 at Blue Oaks	30,585	425	9	06:37	00:04	59.3
	I-80: Sierra College to Antelope	45,827	499	7	08:18	00:05	44.8
	I-80: Auburn to Sierra College	36,777	227	5	06:33	00:01	31.4
	SR-65: I-80 to Sunset	43,107	162	6	04:17	00:01	22.9
	SR-65: Sunset to Ferrari Ranch	45,816	33	3	03:31	00:03	21.0
	SR-65: Ferrari Ranch to Sunset	36,773	122	3	03:43	00:06	25.1
	SR-65: Sunset to I-80	30,586	403	11	04:21	00:08	25.5

VISSIM Post-Processor
Average Values from 10 Runs
Network Statistics

SR 65 Widening
Construction Year - HOV Lane Alternative
PM Peak Period

Network Performance	Vehicle Types	Average	Std. Dev.
Number of Vehicles Served	All Vehicles	231,395	372
Travel Distance [mi]	All Vehicles	924,671	1,366
Travel Time [h]	All Vehicles	27,208	152.8
Average Speed [mph]	All Vehicles	34.0	0.2
Total Delay [h]	All Vehicles	10,937	160.1
Average Delay per Vehicle [s]	All Vehicles	166	2.6
VHD/VMT [min/mile]	All Vehicles	0.71	0.01
Number of Vehicles Served	HOV	45,782	104
Travel Distance [mi]	HOV	199,634	531
Travel Time [h]	HOV	5,111	24
Average Speed [mph]	HOV	39.1	0.2
Total Delay [h]	HOV	1,642	25
Average Delay per Vehicle [s]	HOV	127	2
VHD/VMT [min/mile]	HOV	0.49	0.01
Number of Vehicles Served	Truck	8,906	20
Travel Distance [mi]	Truck	36,993	431
Travel Time [h]	Truck	1,196	23
Average Speed [mph]	Truck	30.9	0
Total Delay [h]	Truck	539	17
Average Delay per Vehicle [s]	Truck	212	6
VHD/VMT [min/mile]	Truck	0.87	0.02

Performance Measure	Vehicle Types		
	HOV	Truck	All
Vehicles Served	45,780	8,910	231,400
Demand Volume	46,980	9,680	233,230
Percent Demand Served	97.4%	92.0%	99.2%
Vehicle Miles of Travel	199,630	36,990	924,670
Person Miles of Travel	419,230	38,840	1,146,120
Vehicle Hours of Travel	5,110	1,200	27,210
Vehicle Hours of Delay	1,640	540	10,940
VHD % of VHT	32.1%	45.0%	40.2%
Average Delay per Vehicle (min)	2.15	3.64	2.84
Person Hours of Delay	3,440	570	12,770
Average Travel Speed	39.1	30.9	34.0

VISSIM Post-Processor
Average Values from 10 Runs
Peak Hour Travel Time

SR 65 Widening
Construction Year - HOV Lane Alternative
PM Peak Period

Mode	Description	Distance (ft)	Volume (vehicles)		Travel Time (min.:sec.)		Speed (mph)
			Average	Std. Dev.	Average	Std. Dev.	Average
SOV	SR-65 at Blue Oaks to I-80 at Antelope	43,101	663	13	08:18	00:02	23.6
	I-80 at Auburn to SR-65 at Blue Oaks	30,589	1,217	18	20:03	00:54	6.9
	I-80: Sierra College to Antelope	45,827	502	8	08:16	00:01	25.2
	I-80: Auburn to Sierra College	36,777	685	13	19:47	01:02	8.5
	SR-65: I-80 to Sunset	43,110	1,216	18	04:22	00:05	44.8
	SR-65: Sunset to Ferrari Ranch	45,816	296	9	03:34	00:00	58.4
	SR-65: Ferrari Ranch to Sunset	36,773	688	12	03:31	00:00	47.5
	SR-65: Sunset to I-80	30,590	836	9	04:12	00:01	33.1
HOV	SR-65 at Blue Oaks to I-80 at Antelope	43,101	272	8	08:12	00:02	44.8
	I-80 at Auburn to SR-65 at Blue Oaks	30,589	722	12	09:23	00:29	58.4
	I-80: Sierra College to Antelope	45,827	199	5	08:09	00:02	47.5
	I-80: Auburn to Sierra College	36,777	290	7	08:32	00:36	33.1
	SR-65: I-80 to Sunset	43,110	448	12	04:22	00:05	23.9
	SR-65: Sunset to Ferrari Ranch	45,816	65	4	03:34	00:01	14.8
	SR-65: Ferrari Ranch to Sunset	36,773	101	5	03:30	00:01	25.6
	SR-65: Sunset to I-80	30,590	212	7	04:09	00:01	19.6

Location	Facility Type	Mainline Volume (vph)			On-ramp Volume (vph)			Off-ramp Volume (vph)			Speed (mph)		Density (vplpm)		LOS
		Avg.	St. Dev.	%	Avg.	St. Dev.	%	Avg.	St. Dev.	%	Avg.	St. Dev.	Avg.	St. Dev.	
1 I-80 EB - Auburn Blvd On-ramp	Merge	7,230	34	110.2%	1,023	17	110.0%				62.1	0.4	28.6	0.2	D
2 I-80 EB - Auburn Blvd to Douglas Blvd	Basic	8,244	48	110.1%							59.5	1.8	34.3	1.2	D
3 I-80 EB - Douglas Blvd Slip Off	Diverge	8,238	66	110.0%				1,401	74	107.8%	59.8	2.6	29.9	1.7	D
4 I-80 EB - Douglas Blvd WB Off-ramp	Diverge	6,828	162	110.3%				502	45	106.8%	62.2	1.0	23.3	1.2	C
5 I-80 EB - Douglas Blvd Off to On-ramp	Basic	6,324	158	110.6%							63.1	0.2	24.8	0.8	C
6 I-80 EB - Douglas Blvd On-ramp	Merge	6,323	149	110.5%	849	21	93.3%				62.1	0.8	28.2	1.2	D
7 I-80 EB - Eureka Rd Off-ramp	Diverge	7,173	135	108.2%				1,359	63	107.0%	60.8	2.3	30.2	2.7	D
8 I-80 EB - Eureka Rd Off to On-ramp	Basic	5,809	130	108.4%							62.8	0.5	24.7	0.5	C
9 I-80 EB - Eureka Rd EB On-ramp	Merge	5,809	135	108.4%	186	9	97.7%				63.1	0.1	22.9	0.7	C
10 I-80 EB - Eureka Rd to Taylor Rd	Weave	5,998	141	108.1%	444	38	103.3%	377	34	107.6%	62.5	0.3	25.1	0.5	C
11 I-80 EB - Taylor Rd to SR 65	Basic	6,066	143	107.7%							59.5	2.3	31.3	1.6	D
17 I-80 EB - SR 65 Off-ramp	Diverge	6,068	139	107.8%				3,214	117	108.2%	59.0	5.1	33.2	5.5	D
18 I-80 EB - SR 65 Off to On-ramp	Basic	2,854	79	107.3%							63.9	0.1	15.7	0.4	B
19 I-80 EB - SR-65 On-ramp	Merge	2,854	84	107.3%	1,561	82	108.4%				62.8	0.2	22.9	1.0	C
21 I-80 EB - SR-65 to Rocklin Rd	Basic	4,417	117	107.7%							63.4	0.1	21.6	0.6	C
22 I-80 EB - Rocklin Rd Off-ramp	Diverge	4,422	119	107.8%				1,490	82	104.9%	63.5	0.2	21.0	0.4	C
23 I-80 EB - Rocklin Rd Off to On-ramp	Basic	2,934	96	109.5%							63.7	0.1	18.2	0.7	C
24 I-80 EB - Rocklin Rd On-ramp	Merge	2,935	102	109.5%	180	7	94.8%				61.7	0.7	18.4	0.7	B
25 I-80 EB - Rocklin Rd to Sierra College Blvd	Basic	3,119	105	108.7%							63.5	0.2	19.0	0.7	C
26 I-80 EB - Sierra College Blvd Off-ramp	Diverge	3,118	111	108.7%				413	39	105.8%	63.1	0.2	20.1	0.8	C
27 I-80 EB - Sierra College Blvd Off to On-ramp	Basic	2,709	102	109.2%							63.7	0.1	17.3	0.7	B
28 I-80 EB - Sierra College Blvd SB On-ramp	Merge	2,712	104	109.3%	131	4	101.1%				62.9	0.2	16.3	0.6	B
29 I-80 EB - Sierra College Blvd NB On-ramp	Merge	2,848	105	109.1%	417	11	109.7%				62.3	0.6	18.0	0.6	B
38 I-80 WB - Sierra College Blvd Off-ramp	Diverge	4,879	23	105.8%				850	49	106.2%	57.2	1.1	27.8	0.4	C
39 I-80 WB - Sierra College Blvd Off to On-ramp	Basic	4,030	66	105.8%							62.1	0.4	24.8	0.3	C
40 I-80 WB - Sierra College Blvd NB On-ramp	Merge	4,032	68	105.8%	51	4	84.7%				62.9	0.3	22.1	0.5	C
41 I-80 WB - Sierra College Blvd SB On-ramp	Merge	4,079	72	105.4%	310	11	103.4%				61.5	0.6	23.6	0.4	C
42 I-80 WB - Sierra College Blvd to Rocklin Rd	Basic	4,389	77	105.2%							62.3	0.3	26.6	0.4	D
43 I-80 WB - Rocklin Rd Off-ramp	Diverge	4,387	80	105.2%				227	26	103.4%	61.0	0.7	27.5	0.5	C
44 I-80 WB - Rocklin Rd Off to On-ramp	Basic	4,159	89	105.3%							62.9	0.2	24.9	0.5	C
45 I-80 WB - Rocklin Rd On-ramp	Merge	4,158	89	105.3%	903	54	101.4%				60.7	0.6	26.6	0.7	C
46 I-80 WB - Rocklin Rd to HOV Lane Start	Basic	5,054	120	104.4%							62.3	0.3	28.7	0.6	D
47 I-80 WB - HOV Lane Start to SR-65	Basic	5,054	129	104.4%							62.1	0.2	24.1	0.5	C
48 I-80 WB - SR-65 Off-ramp	Diverge	5,052	131	104.4%				1,466	55	106.2%	63.5	0.2	22.0	0.5	C
49 I-80 WB - SR-65 Off to On-ramp	Basic	3,582	123	103.5%							63.7	0.1	19.6	0.4	C
50 I-80 WB - SR-65 On-ramp	Merge	3,582	121	103.5%	3,902	100	104.6%				60.5	0.7	30.0	1.0	D
60 I-80 WB - Taylor Rd On-ramp	Merge	7,481	157	104.1%	626	35	111.8%				54.3	4.6	38.3	3.6	E
61 I-80 WB - Atlantic St WB Off-ramp	Diverge	8,106	157	104.6%				343	33	104.0%	59.2	1.6	35.7	1.7	E
62 I-80 WB - Atlantic St EB Off-ramp	Diverge	7,761	144	104.6%				997	54	102.8%	61.6	0.7	34.9	0.6	D
63 I-80 WB - Atlantic St EB Off to On-ramp	Basic	6,763	131	104.9%							62.9	0.2	26.9	0.6	D
64 I-80 WB - Atlantic St On-ramp	Merge	6,759	137	104.8%	1,182	66	107.5%				57.3	4.1	37.0	2.9	E
65 I-80 WB - Douglas Blvd Off-ramp	Diverge	7,936	143	105.1%				956	46	101.7%	60.0	0.6	32.9	0.8	D
66 I-80 WB - Douglas Blvd Off to On-ramp	Basic	6,976	140	105.5%							62.8	0.2	28.3	0.4	D
67 I-80 WB - Douglas Blvd WB On-ramp	Merge	6,975	142	105.5%	1,020	44	107.4%				58.7	1.2	30.8	1.1	D
68 I-80 WB - Douglas Blvd Slip On	Merge	7,995	155	105.8%	453	32	105.4%				58.3	5.0	35.4	4.4	E
69 I-80 WB - Douglas Blvd to Riverside Ave	Basic	8,452	150	105.8%							61.8	0.3	33.9	0.5	D
70 I-80 WB - Riverside Ave Off-ramp	Diverge	8,457	144	105.8%				902	55	99.2%	62.4	0.1	33.6	0.6	D
71 I-80 WB - Riverside Ave Off to On-ramp	Basic	7,559	151	106.8%							62.7	0.1	30.1	0.6	D
72 I-80 WB - Riverside Ave NB On-ramp	Merge	7,559	151	106.8%	285	6	83.8%				63.0	0.1	28.2	0.8	D
73 I-80 WB - Riverside Ave SB On-ramp	Merge	7,840	155	105.7%	823	14	100.3%				62.5	0.2	34.5	0.9	D
74 I-80 WB - Riverside Ave to Antelope Rd	Basic	8,660	152	105.1%							52.6	11.0	40.8	10.8	E
75 I-80 WB - Antelope Rd Off-ramp	Diverge	8,663	185	105.1%				345	27	90.7%	43.8	12.9	53.3	16.1	F
76 I-80 WB - Antelope Rd Off to On-ramp	Basic	8,335	216	106.0%							40.8	15.2	62.1	24.8	F
77 I-80 WB - Antelope Rd WB On-ramp	Merge	8,338	228	106.1%	566	12	97.6%				31.9	10.8	80.1	21.8	F
78 I-80 WB - Antelope Rd to Truck Scales	Weave	8,919	241	105.7%	444	14	96.6%	91	18	82.8%	33.0	7.3	70.4	11.5	F
79 I-80 WB - Truck Scales Off to On-ramp	Basic	9,367	228	106.6%							30.6	2.2	81.8	6.3	F
80 I-80 WB - Truck Scales On-ramp	Merge	9,404	231	107.0%	91	17	82.5%				29.2	1.8	91.6	5.9	F
81 I-80 WB - Truck Scales to Elkhorn Blvd	Basic	9,569	220	107.5%							34.4	4.3	68.4	7.7	F
82 I-80 WB - Elkhorn Blvd Off-ramp	Diverge	9,578	213	107.6%				809	61	109.4%	36.8	9.0	55.2	10.8	F
83 I-80 WB - Elkhorn Blvd Off to On-ramp	Basic	8,806	131	107.9%							28.1	5.2	87.8	13.9	F
84 I-80 WB - Elkhorn Blvd WB On-ramp	Merge	8,822	119	108.1%	803	10	95.6%				26.7	1.0	95.5	5.0	F
85 I-80 WB - Elkhorn Blvd EB On-ramp	Merge	9,637	109	107.1%	882	25	95.8%				32.7	0.4	76.9	1.0	F

Notes: Average density reported for the analysis area only: for example, within the ramp influence area and not including the HOV lane.
Mainline volume is the upstream served volume for all lanes.

VISSIM Post-Processor
Average Results from 10 Runs
Freeway Operations Summary

SR 65 Widening
Construction Year - HOV Lane Alternative
AM Peak Hour

Location	Facility Type	Mainline Volume (vph)			On-ramp Volume (vph)			Off-ramp Volume (vph)			Speed (mph)		Density (vplpm)		LOS
		Avg.	St. Dev.	%	Avg.	St. Dev.	%	Avg.	St. Dev.	%	Avg.	St. Dev.	Avg.	St. Dev.	
100 SR-65 NB - EB I-80 Connector	Basic	3,216	117	108.3%							41.5	1.7	45.4	4.0	F
101 SR-65 NB - WB I-80 Connector	Basic	1,465	55	106.2%							51.4	0.3	23.4	0.7	C
103 SR-65 NB - I-80 WB On-ramp	Merge	3,215	106	108.2%	1,466	55	106.2%				61.1	0.6	28.3	1.1	D
104 SR-65 NB - I-80 to Stanford Ranch Rd	Basic	4,682	133	107.6%							63.0	0.2	27.1	0.9	D
105 SR-65 NB - Stanford Ranch Rd Off-ramp	Diverge	4,682	133	107.6%				694	53	103.6%	62.9	0.2	25.2	0.8	C
106 SR-65 NB - Stanford Ranch Rd Off to On-ramp	Basic	3,987	113	108.3%							63.2	0.2	23.3	0.7	C
107 SR-65 NB - Stanford Ranch Rd to Pleasant Grove Blvd	Weave	3,986	119	108.3%	903	52	108.8%	651	46	101.6%	62.4	0.3	23.9	0.6	C
110 SR-65 NB - Pleasant Grove Blvd Off to On-ramp	Basic	4,240	131	109.6%							62.8	0.2	25.0	0.7	C
111 SR-65 NB - Pleasant Grove Blvd On-ramp	Merge	4,239	126	109.5%	230	24	100.0%				60.5	0.6	33.1	1.1	D
112 SR-65 NB - Blue Oaks Blvd Off-ramp	Diverge	4,470	115	109.0%				1,969	93	109.4%	62.2	0.4	27.0	0.6	C
114 SR-65 NB - Blue Oaks Blvd Off to On-ramp	Basic	2,502	72	108.8%							63.3	0.2	22.0	0.6	C
115 SR-65 NB - Blue Oaks Blvd On-ramp	Merge	2,504	71	108.9%	522	35	100.4%				62.6	0.2	19.0	0.4	B
116 SR-65 NB - Blue Oaks Blvd to Sunset Blvd	Basic	3,029	82	107.4%							63.5	0.2	18.9	0.3	C
118 SR-65 NB - Sunset Blvd Off-ramp	Diverge	3,029	78	107.4%				1,316	55	107.9%	63.6	0.1	18.3	0.5	B
119 SR-65 NB - Sunset Blvd Off to On-ramp	Basic	1,712	66	107.0%							63.7	0.2	14.9	0.6	B
120 SR-65 NB - Sunset Blvd EB On-ramp	Merge	1,711	66	106.9%	54	12	107.4%				63.7	0.4	15.0	0.6	B
121 SR-65 NB - Sunset Blvd to Whitney Ranch Pkwy	Weave	1,765	67	107.0%	161	16	107.1%	354	37	98.4%	63.5	0.2	14.3	0.4	B
124 SR-65 NB - Whitney Ranch Pkwy Off to On-ramp	Basic	1,576	55	109.5%							63.7	0.2	13.9	0.3	B
125 SR-65 NB - Whitney Ranch Pkwy EB On-ramp	Merge	1,576	56	109.5%	185	15	97.2%				63.5	0.2	14.3	0.4	B
126 SR-65 NB - Whitney Ranch Pkwy to Twelve Bridges Dr	Weave	1,763	63	108.1%	212	12	106.1%	412	37	95.8%	63.7	0.3	13.0	0.3	B
129 SR-65 NB - Twelve Bridges Dr Off to On-ramp	Basic	1,563	73	111.6%							63.8	0.2	14.4	0.6	B
130 SR-65 NB - Twelve Bridges Dr to Lincoln Blvd	Weave	1,564	70	111.7%	266	29	106.3%	646	60	113.4%	63.8	0.2	13.0	0.5	B
133 SR-65 NB - Lincoln Blvd to Ferrari Ranch Rd	Basic	1,184	56	109.6%							64.1	0.2	12.8	0.4	B
134 SR-65 NB - Ferrari Ranch Rd Off-ramp	Diverge	1,183	56	109.6%				702	52	107.9%	64.4	0.2	10.4	0.3	B
135 SR-65 NB - Ferrari Ranch Rd Off to On-ramp	Basic	482	42	112.1%							64.6	0.3	4.7	0.5	A
136 SR-65 NB - Ferrari Ranch Rd On-ramp	Merge	483	44	112.2%	114	8	103.6%				62.4	0.3	5.3	0.5	A
150 SR-65 SB - Ferrari Ranch Rd Off-ramp	Diverge	1,050	31	114.1%				74	16	105.7%	64.3	0.1	11.3	0.3	B
151 SR-65 SB - Ferrari Ranch Rd Off to On-ramp	Basic	975	33	114.7%							64.2	0.1	10.5	0.3	A
152 SR-65 SB - Ferrari Ranch Rd WB On-ramp	Merge	975	34	114.8%	899	18	108.3%				60.4	0.2	14.0	0.3	B
153 SR-65 SB - Ferrari Ranch Rd EB On-ramp	Merge	1,874	40	111.6%	708	24	93.1%				60.2	0.4	18.9	0.6	B
154 SR-65 SB - Ferrari Ranch Rd to Lane Drop	Basic	2,583	48	105.9%							62.5	0.6	26.7	0.5	D
155 SR-65 SB - Lane Drop to Lincoln Blvd	Basic	2,582	48	105.8%							62.9	0.3	26.7	0.5	D
156 SR-65 SB - Lincoln Blvd to Twelve Bridges Dr	Weave	2,582	51	105.8%	900	48	105.9%	326	36	108.6%	59.9	0.5	26.6	0.6	C
159 SR-65 SB - Twelve Bridges Dr Off to On-ramp	Basic	3,159	71	105.6%							61.7	0.5	30.2	0.8	D
160 SR-65 SB - Twelve Bridges Dr to Placer Pkwy	Weave	3,158	68	105.6%	859	30	113.1%	445	46	111.2%	61.1	0.2	27.8	0.6	C
163 SR-65 SB - Placer Pkwy Off to On-ramp	Basic	3,562	72	106.3%							62.0	0.3	31.7	0.7	D
164 SR-65 SB - Placer Pkwy WB On-ramp	Merge	3,560	70	106.3%	287	26	106.3%				58.2	5.3	33.5	3.6	D
165 SR-65 SB - Placer Pkwy to Sunset Blvd	Weave	3,849	71	106.3%	236	23	112.2%	479	38	104.1%	51.5	8.3	40.1	9.4	E
168 SR-65 SB - Sunset Blvd Off to On-ramp	Basic	3,610	64	107.1%							31.6	16.3	71.1	23.6	F
169 SR-65 SB - Sunset Blvd WB On-ramp	Merge	3,609	71	107.1%	612	29	111.2%				32.4	11.2	67.8	16.3	F
170 SR-65 SB - Sunset Blvd to Blue Oaks Blvd	Weave	4,220	64	107.6%	453	15	100.6%	904	49	106.3%	59.8	0.4	31.3	0.8	D
172 SR-65 SB - Blue Oaks Blvd Off to HOV Lane Start	Basic	3,764	87	106.9%							62.0	0.1	32.3	0.7	D
173 SR-65 SB - HOV Lane Start to Blue Oaks Blvd On	Basic	3,763	86	106.9%							61.9	0.4	31.7	0.7	D
174 SR-65 SB - Blue Oaks Blvd WB On-ramp	Merge	3,762	87	106.9%	555	31	106.7%				56.1	2.2	34.8	1.7	D
175 SR-65 SB - Blue Oaks Blvd WB to EB On-ramp	Basic	4,318	86	106.9%							61.7	1.0	34.2	1.1	D
176 SR-65 SB - Blue Oaks Blvd EB On-ramp	Merge	4,318	88	106.9%	1,157	50	101.5%				60.8	0.6	30.1	0.8	D
177 SR-65 SB - Pleasant Grove Blvd Off-ramp	Diverge	5,476	99	105.7%				705	58	106.8%	61.9	1.6	27.9	1.1	C
178 SR-65 SB - Pleasant Grove Blvd Off to On-ramp	Basic	4,770	87	105.5%							63.0	0.5	25.4	0.4	C
179 SR-65 SB - Pleasant Grove Blvd WB On-ramp	Merge	4,768	92	105.5%	441	35	102.5%				62.1	0.3	24.6	0.5	C
180 SR-65 SB - Pleasant Grove Blvd EB On-ramp	Merge	5,209	102	105.2%	615	44	102.4%				60.5	1.0	17.2	0.6	B
181 SR-65 SB - Pleasant Grove Blvd to Galleria Blvd	Basic	5,821	119	104.9%							58.6	1.7	29.5	1.0	D
182 SR-65 SB - Galleria Blvd Off-ramp	Diverge	5,822	119	104.9%				1,151	61	101.0%	62.0	0.9	24.9	0.6	C
183 SR-65 SB - Galleria Blvd Off-ramp to Lane Drop	Basic	4,674	133	106.0%							58.0	9.4	31.9	7.5	D
184 SR-65 SB - Lane Drop to Galleria Blvd On-ramp	Basic	4,680	132	106.1%							52.9	13.4	37.7	15.5	E
185 SR-65 SB - Galleria Blvd On-ramp	Merge	4,683	129	106.2%	773	33	101.7%				44.5	10.9	54.1	16.9	F
186 SR-65 SB - I-80 Off-ramp	Diverge	5,457	142	105.6%				3,902	106	104.6%	59.0	1.6	33.3	1.4	D
187 SR-65 SB - EB I-80 Connector (2 lanes)	Basic	1,558	84	108.2%							59.5	1.8	30.1	2.2	D
188 SR-65 SB - EB I-80 Connector (1 lane)	Basic	1,559	83	108.3%							61.4	0.5	29.3	1.7	D
189 SR-65 SB - WB I-80 Connector	Basic	3,905	102	104.7%							51.5	0.4	40.6	1.3	E

Notes: Average density reported for the analysis area only: for example, within the ramp influence area and not including the HOV lane.
Mainline volume is the upstream served volume for all lanes.

VISSIM Post-Processor
Average Results from 10 Runs
Freeway Operations Summary

SR 65 Widening
Construction Year - HOV Lane Alternative
PM Peak Hour

Location	Facility Type	Mainline Volume (vph)			On-ramp Volume (vph)			Off-ramp Volume (vph)			Speed (mph)		Density (vplpm)		LOS
		Avg.	St. Dev.	%	Avg.	St. Dev.	%	Avg.	St. Dev.	%	Avg.	St. Dev.	Avg.	St. Dev.	
1 I-80 EB - Auburn Blvd On-ramp	Merge	7,162	306	96.7%	896	55	92.3%				23.4	0.6	126.1	6.3	F
2 I-80 EB - Auburn Blvd to Douglas Blvd	Basic	7,790	398	93.0%							23.2	1.5	108.0	5.1	F
3 I-80 EB - Douglas Blvd Slip Off	Diverge	7,695	511	91.8%				1,030	136	88.8%	25.9	2.2	91.8	10.1	F
4 I-80 EB - Douglas Blvd WB Off-ramp	Diverge	6,578	406	91.1%				602	86	86.0%	22.9	0.6	145.5	10.9	F
5 I-80 EB - Douglas Blvd Off to On-ramp	Basic	5,898	326	90.5%							22.1	1.5	133.3	6.4	F
6 I-80 EB - Douglas Blvd On-ramp	Merge	5,867	328	90.0%	1,121	106	84.3%				14.8	1.2	138.2	5.3	F
7 I-80 EB - Eureka Rd Off-ramp	Diverge	6,970	405	88.8%				860	96	81.9%	19.2	1.4	117.6	8.3	F
8 I-80 EB - Eureka Rd Off to On-ramp	Basic	6,102	318	89.7%							21.0	0.8	129.3	4.6	F
9 I-80 EB - Eureka Rd EB On-ramp	Merge	6,102	345	89.7%	329	21	102.8%				17.0	1.1	136.3	3.9	F
10 I-80 EB - Eureka Rd to Taylor Rd	Weave	6,435	392	90.4%	1,126	58	99.7%	489	61	85.8%	18.5	0.6	124.1	3.2	F
11 I-80 EB - Taylor Rd to SR 65	Basic	7,061	326	91.9%							19.7	1.2	112.4	4.8	F
17 I-80 EB - SR 65 Off-ramp	Diverge	7,051	323	91.8%				3,856	119	93.6%	24.2	2.0	91.4	6.7	F
18 I-80 EB - SR 65 Off to On-ramp	Basic	3,190	203	89.6%							63.2	0.4	17.7	1.6	B
19 I-80 EB - SR-65 On-ramp	Merge	3,193	204	89.7%	1,894	86	97.6%				62.6	0.2	22.5	0.9	C
21 I-80 EB - SR-65 to Rocklin Rd	Basic	5,086	222	92.5%							63.1	0.3	22.4	1.0	C
22 I-80 EB - Rocklin Rd Off-ramp	Diverge	5,080	229	92.4%				1,614	96	94.4%	62.0	4.2	23.3	4.1	C
23 I-80 EB - Rocklin Rd Off to On-ramp	Basic	3,463	179	91.4%							63.3	0.9	19.4	1.3	C
24 I-80 EB - Rocklin Rd On-ramp	Merge	3,464	182	91.4%	273	28	104.8%				60.8	0.5	19.5	0.9	B
25 I-80 EB - Rocklin Rd to Sierra College Blvd	Basic	3,735	173	92.2%							63.4	0.2	20.4	1.0	C
26 I-80 EB - Sierra College Blvd Off-ramp	Diverge	3,732	173	92.1%				271	27	84.8%	62.6	0.8	21.7	1.2	C
27 I-80 EB - Sierra College Blvd Off to On-ramp	Basic	3,457	145	92.7%							63.4	0.2	19.6	1.0	C
28 I-80 EB - Sierra College Blvd SB On-ramp	Merge	3,455	138	92.6%	236	3	94.4%				61.6	0.4	18.7	0.8	B
29 I-80 EB - Sierra College Blvd NB On-ramp	Merge	3,689	146	92.7%	608	13	101.4%				60.8	0.7	22.1	1.0	C
38 I-80 WB - Sierra College Blvd Off-ramp	Diverge	3,662	20	105.8%				583	40	104.1%	60.9	0.4	19.3	0.2	B
39 I-80 WB - Sierra College Blvd Off to On-ramp	Basic	3,078	50	106.1%							63.6	0.2	18.1	0.3	C
40 I-80 WB - Sierra College Blvd NB On-ramp	Merge	3,078	53	106.1%	170	3	100.1%				63.1	0.2	16.7	0.2	B
41 I-80 WB - Sierra College Blvd SB On-ramp	Merge	3,245	57	105.7%	229	5	91.7%				62.9	0.3	17.7	0.2	B
42 I-80 WB - Sierra College Blvd to Rocklin Rd	Basic	3,472	59	104.6%							63.3	0.2	20.0	0.3	C
43 I-80 WB - Rocklin Rd Off-ramp	Diverge	3,471	62	104.5%				284	39	105.0%	62.6	0.5	20.7	0.7	C
44 I-80 WB - Rocklin Rd Off to On-ramp	Basic	3,185	57	104.4%							63.6	0.1	18.5	0.4	C
45 I-80 WB - Rocklin Rd On-ramp	Merge	3,186	68	104.5%	1,269	67	90.6%				60.4	0.7	22.5	0.4	C
46 I-80 WB - Rocklin Rd to HOV Lane Start	Basic	4,448	99	99.9%							62.9	0.2	24.1	0.5	C
47 I-80 WB - HOV Lane Start to SR-65	Basic	4,451	102	100.0%							62.8	0.3	20.2	0.4	C
48 I-80 WB - SR-65 Off-ramp	Diverge	4,450	106	100.0%				1,763	70	98.5%	63.7	0.2	18.3	0.4	B
49 I-80 WB - SR-65 Off to On-ramp	Basic	2,683	73	100.9%							63.9	0.1	15.5	0.4	B
50 I-80 WB - SR-65 On-ramp	Merge	2,684	76	100.9%	3,304	103	100.7%				62.0	0.1	23.4	0.6	C
60 I-80 WB - Taylor Rd On-ramp	Merge	5,989	112	100.8%	541	36	100.1%				60.9	0.5	28.3	0.9	D
61 I-80 WB - Atlantic St WB Off-ramp	Diverge	6,528	119	100.7%				444	36	105.6%	62.4	1.0	27.8	1.1	C
62 I-80 WB - Atlantic St EB Off-ramp	Diverge	6,084	109	100.4%				978	57	99.8%	62.4	0.4	28.6	0.6	D
63 I-80 WB - Atlantic St EB Off to On-ramp	Basic	5,105	102	100.5%							63.5	0.2	20.6	0.4	C
64 I-80 WB - Atlantic St On-ramp	Merge	5,105	108	100.5%	1,410	67	102.9%				60.3	0.8	30.0	0.5	D
65 I-80 WB - Douglas Blvd Off-ramp	Diverge	6,515	116	101.0%				952	50	100.2%	62.0	0.2	27.4	0.7	C
66 I-80 WB - Douglas Blvd Off to On-ramp	Basic	5,571	106	101.3%							63.5	0.1	22.8	0.5	C
67 I-80 WB - Douglas Blvd WB On-ramp	Merge	5,571	107	101.3%	1,412	79	100.8%				60.0	0.5	26.7	0.5	C
68 I-80 WB - Douglas Blvd Slip On	Merge	6,980	108	101.2%	757	43	92.3%				58.3	3.3	32.6	2.1	D
69 I-80 WB - Douglas Blvd to Riverside Ave	Basic	7,745	140	100.3%							61.7	0.4	30.3	0.5	D
70 I-80 WB - Riverside Ave Off-ramp	Diverge	7,747	133	100.4%				1,183	52	101.9%	62.7	0.3	31.4	0.7	D
71 I-80 WB - Riverside Ave Off to On-ramp	Basic	6,566	141	100.1%							63.2	0.2	25.0	0.5	C
72 I-80 WB - Riverside Ave NB On-ramp	Merge	6,566	148	100.1%	206	1	98.0%				63.5	0.1	22.9	0.7	C
73 I-80 WB - Riverside Ave SB On-ramp	Merge	6,774	146	100.1%	521	5	96.5%				61.0	1.2	27.4	1.1	C
74 I-80 WB - Riverside Ave to Antelope Rd	Basic	7,296	136	99.8%							62.1	0.5	28.1	0.6	D
75 I-80 WB - Antelope Rd Off-ramp	Diverge	7,291	138	99.7%				956	67	99.6%	61.6	1.1	29.0	0.8	D
76 I-80 WB - Antelope Rd Off to On-ramp	Basic	6,333	121	99.7%							63.1	0.1	24.4	0.3	C
77 I-80 WB - Antelope Rd WB On-ramp	Merge	6,335	125	99.8%	371	8	97.5%				60.9	0.9	23.0	0.9	C
78 I-80 WB - Antelope Rd to Truck Scales	Weave	6,707	117	99.7%	367	15	99.2%	64	15	57.8%	62.4	0.4	25.1	0.5	C
79 I-80 WB - Truck Scales Off to On-ramp	Basic	7,016	119	100.4%							62.9	0.1	26.1	0.4	D
80 I-80 WB - Truck Scales On-ramp	Merge	7,017	129	100.4%	64	15	58.5%				62.6	0.1	26.3	0.4	C
81 I-80 WB - Truck Scales to Elkhorn Blvd	Basic	7,080	129	99.7%							61.8	0.3	27.6	0.5	D
82 I-80 WB - Elkhorn Blvd Off-ramp	Diverge	7,078	128	99.7%				1,075	58	97.7%	62.4	0.2	25.4	0.5	C
83 I-80 WB - Elkhorn Blvd Off to On-ramp	Basic	6,000	140	100.0%							63.1	0.4	23.2	0.6	C
84 I-80 WB - Elkhorn Blvd WB On-ramp	Merge	6,002	138	100.0%	899	3	99.9%				58.4	0.6	24.4	0.8	C
85 I-80 WB - Elkhorn Blvd EB On-ramp	Merge	6,902	149	100.0%	656	16	102.5%				61.7	0.8	28.1	1.1	D

Notes: Average density reported for the analysis area only: for example, within the ramp influence area and not including the HOV lane.
Mainline volume is the upstream served volume for all lanes.

VISSIM Post-Processor
Average Results from 10 Runs
Freeway Operations Summary

SR 65 Widening
Construction Year - HOV Lane Alternative
PM Peak Hour

Location	Facility Type	Mainline Volume (vph)			On-ramp Volume (vph)			Off-ramp Volume (vph)			Speed (mph)		Density (vplpm)		LOS
		Avg.	St. Dev.	%	Avg.	St. Dev.	%	Avg.	St. Dev.	%	Avg.	St. Dev.	Avg.	St. Dev.	
100 SR-65 NB - EB I-80 Connector	Basic	3,856	107	93.6%							36.4	0.8	61.3	1.9	F
101 SR-65 NB - WB I-80 Connector	Basic	1,761	66	98.4%							50.2	0.6	28.0	0.7	D
103 SR-65 NB - I-80 WB On-ramp	Merge	3,857	103	93.6%	1,759	66	98.3%				60.4	0.6	32.4	0.5	D
104 SR-65 NB - I-80 to Stanford Ranch Rd	Basic	5,614	133	95.0%							62.9	0.2	30.8	0.3	D
105 SR-65 NB - Stanford Ranch Rd Off-ramp	Diverge	5,614	134	95.0%				1,101	52	93.3%	62.3	0.8	29.7	0.6	D
106 SR-65 NB - Stanford Ranch Rd Off to On-ramp	Basic	4,509	144	95.3%							63.0	0.3	25.3	0.5	C
107 SR-65 NB - Stanford Ranch Rd to Pleasant Grove Blvd	Weave	4,505	145	95.2%	1,397	54	101.3%	1,009	59	98.9%	61.7	0.5	26.1	0.6	C
110 SR-65 NB - Pleasant Grove Blvd Off to On-ramp	Basic	4,892	136	96.1%							58.4	13.6	33.2	20.3	D
111 SR-65 NB - Pleasant Grove Blvd On-ramp	Merge	4,889	134	96.0%	548	28	99.7%				53.7	10.8	38.6	12.6	E
112 SR-65 NB - Blue Oaks Blvd Off-ramp	Diverge	5,432	145	96.3%				1,857	95	94.3%	60.7	1.0	31.6	1.0	D
114 SR-65 NB - Blue Oaks Blvd Off to On-ramp	Basic	3,574	123	97.4%							62.6	0.3	28.8	1.2	D
115 SR-65 NB - Blue Oaks Blvd On-ramp	Merge	3,574	123	97.4%	836	53	104.5%				61.5	0.5	25.8	1.0	C
116 SR-65 NB - Blue Oaks Blvd to Sunset Blvd	Basic	4,410	142	98.7%							62.1	0.4	26.5	0.9	D
118 SR-65 NB - Sunset Blvd Off-ramp	Diverge	4,409	136	98.6%				999	47	98.9%	62.5	0.3	27.7	1.1	C
119 SR-65 NB - Sunset Blvd Off to On-ramp	Basic	3,412	124	98.6%							62.5	0.2	28.2	1.2	D
120 SR-65 NB - Sunset Blvd EB On-ramp	Merge	3,410	122	98.6%	80	14	99.8%				62.0	0.6	28.6	1.2	D
121 SR-65 NB - Sunset Blvd to Whitney Ranch Pkwy	Weave	3,488	128	98.5%	234	17	101.6%	549	35	96.2%	62.1	0.3	26.8	1.1	C
124 SR-65 NB - Whitney Ranch Pkwy Off to On-ramp	Basic	3,173	120	99.2%							62.6	0.2	26.6	1.2	D
125 SR-65 NB - Whitney Ranch Pkwy EB On-ramp	Merge	3,171	120	99.1%	266	10	95.1%				61.3	1.6	28.0	1.6	C
126 SR-65 NB - Whitney Ranch Pkwy to Twelve Bridges Dr	Weave	3,436	121	98.7%	271	14	100.3%	832	58	102.7%	62.6	0.3	23.3	0.9	C
129 SR-65 NB - Twelve Bridges Dr Off to On-ramp	Basic	2,864	84	97.4%							62.8	0.2	24.4	0.5	C
130 SR-65 NB - Twelve Bridges Dr to Lincoln Blvd	Weave	2,862	88	97.3%	276	32	91.9%	1,096	57	98.7%	63.1	0.2	20.3	0.5	C
133 SR-65 NB - Lincoln Blvd to Ferrari Ranch Rd	Basic	2,039	73	95.7%							63.4	0.2	19.3	0.8	C
134 SR-65 NB - Ferrari Ranch Rd Off-ramp	Diverge	2,038	73	95.7%				1,388	65	95.7%	64.0	0.2	15.0	0.5	B
135 SR-65 NB - Ferrari Ranch Rd Off to On-ramp	Basic	650	60	95.6%							64.6	0.1	5.4	0.4	A
136 SR-65 NB - Ferrari Ranch Rd On-ramp	Merge	650	59	95.6%	83	5	92.0%				63.2	0.2	5.7	0.4	A
150 SR-65 SB - Ferrari Ranch Rd Off-ramp	Diverge	981	33	101.1%				144	14	96.1%	64.5	0.3	8.4	0.3	A
151 SR-65 SB - Ferrari Ranch Rd Off to On-ramp	Basic	837	35	102.0%							64.5	0.2	7.0	0.2	A
152 SR-65 SB - Ferrari Ranch Rd WB On-ramp	Merge	837	37	102.0%	477	18	99.3%				61.8	0.2	7.9	0.2	A
153 SR-65 SB - Ferrari Ranch Rd EB On-ramp	Merge	1,313	48	101.0%	320	15	91.5%				62.0	0.1	11.3	0.5	B
154 SR-65 SB - Ferrari Ranch Rd to Lane Drop	Basic	1,632	49	98.9%							64.1	0.2	14.1	0.5	B
155 SR-65 SB - Lane Drop to Lincoln Blvd	Basic	1,632	49	98.9%							64.2	0.1	14.0	0.5	B
156 SR-65 SB - Lincoln Blvd to Twelve Bridges Dr	Weave	1,631	52	98.8%	733	44	99.0%	258	34	95.6%	62.5	0.5	14.7	0.4	B
159 SR-65 SB - Twelve Bridges Dr Off to On-ramp	Basic	2,102	55	99.2%							63.6	0.3	17.1	0.4	B
160 SR-65 SB - Twelve Bridges Dr to Placer Pkwy	Weave	2,102	55	99.2%	470	20	95.8%	458	38	97.4%	63.1	0.2	15.9	0.3	B
163 SR-65 SB - Placer Pkwy Off to On-ramp	Basic	2,110	64	98.6%							63.6	0.2	17.3	0.5	B
164 SR-65 SB - Placer Pkwy WB On-ramp	Merge	2,111	67	98.6%	260	22	100.0%				62.9	0.4	18.6	0.6	B
165 SR-65 SB - Placer Pkwy to Sunset Blvd	Weave	2,371	67	98.8%	363	24	98.2%	264	32	97.8%	62.8	0.2	19.3	0.6	B
168 SR-65 SB - Sunset Blvd Off to On-ramp	Basic	2,469	71	98.8%							63.1	0.2	20.2	0.5	C
169 SR-65 SB - Sunset Blvd WB On-ramp	Merge	2,469	69	98.8%	788	33	107.9%				58.5	1.9	25.2	0.9	C
170 SR-65 SB - Sunset Blvd to Blue Oaks Blvd	Weave	3,258	80	100.9%	750	34	101.3%	745	52	96.8%	62.0	0.3	24.6	0.6	C
173 SR-65 SB - HOV Lane Start to Blue Oaks Blvd WB On	Basic	3,260	82	101.9%							62.6	0.2	26.5	0.8	D
174 SR-65 SB - Blue Oaks Blvd WB On-ramp	Merge	3,260	82	101.9%	500	27	104.2%				59.7	0.6	27.8	0.7	C
175 SR-65 SB - Blue Oaks Blvd WB to EB On-ramp	Basic	3,761	82	102.2%							62.8	0.2	28.6	0.6	D
176 SR-65 SB - Blue Oaks Blvd EB On-ramp	Merge	3,761	84	102.2%	1,210	47	101.6%				61.7	0.2	26.3	0.4	C
177 SR-65 SB - Pleasant Grove Blvd Off-ramp	Diverge	4,972	101	102.1%				565	44	95.8%	63.0	0.5	24.9	0.4	C
178 SR-65 SB - Pleasant Grove Blvd Off to On-ramp	Basic	4,403	103	102.9%							63.3	0.3	22.7	0.4	C
179 SR-65 SB - Pleasant Grove Blvd WB On-ramp	Merge	4,402	103	102.8%	282	7	94.1%				62.8	0.1	21.0	0.5	C
180 SR-65 SB - Pleasant Grove Blvd EB On-ramp	Merge	4,683	104	102.3%	734	25	96.6%				61.9	0.5	15.3	0.4	B
181 SR-65 SB - Pleasant Grove Blvd to Galleria Blvd	Basic	5,419	120	101.5%							61.0	0.6	25.3	0.5	C
182 SR-65 SB - Galleria Blvd Off-ramp	Diverge	5,420	119	101.5%				1,178	64	104.2%	62.9	0.7	22.2	0.7	C
183 SR-65 SB - Galleria Blvd Off-ramp to Lane Drop	Basic	4,236	109	100.6%							62.1	1.2	26.9	0.6	D
184 SR-65 SB - Lane Drop to Galleria Blvd On-ramp	Basic	4,235	109	100.6%							62.4	0.3	25.2	0.6	C
185 SR-65 SB - Galleria Blvd On-ramp	Merge	4,233	110	100.6%	967	39	95.7%				57.1	3.3	33.9	2.5	D
186 SR-65 SB - I-80 Off-ramp	Diverge	5,200	104	99.6%				3,311	93	100.9%	61.2	0.5	29.1	0.7	D
187 SR-65 SB - EB I-80 Connector (2 lanes)	Basic	1,892	76	97.5%							56.4	3.0	34.6	2.2	D
188 SR-65 SB - EB I-80 Connector (1 lane)	Basic	1,894	80	97.6%							60.1	0.9	33.0	1.3	D
189 SR-65 SB - WB I-80 Connector	Basic	3,308	98	100.8%							52.5	0.2	32.4	1.0	D

Notes: Average density reported for the analysis area only: for example, within the ramp influence area and not including the HOV lane.
Mainline volume is the upstream served volume for all lanes.

VISSIM Post-Processor
Average Results from 10 Runs
Intersection Volume and Delay

SR 65 Widening
Construction Year - HOV Lane Alternative
AM Peak Hour

	Intersection	Control	Volume (vph)		Percent Served	Delay (sec/veh)		Level of Service
			Demand	Served		Average	Std. Dev.	
1	Lincoln Blvd/Sterling Parkway	Signal	1,860	2,034	109.4%	11.1	0.7	B
2	SR-65 SB Ramps/Twelve Bridges Dr	Signal	1,285	1,436	111.8%	10.2	0.7	B
3	SR-65 NB Ramps/Twelve Bridges Dr	Signal	1,385	1,490	107.6%	8.9	1.4	A
4	SR-65 SB Ramps/Sunset Blvd	Signal	2,660	2,878	108.2%	11.4	1.1	B
5	SR-65 NB Ramps/Sunset Blvd	Signal	2,790	3,068	109.9%	12.9	0.8	B
6	SR-65 SB Ramps-Washington Blvd/Blue Oaks Blvd	Signal	4,535	4,723	104.1%	31.0	3.0	C
7	SR-65 NB Ramps/Blue Oaks Blvd	Signal	3,095	3,315	107.1%	12.2	1.3	B
8	SR-65 SB Ramps/Pleasant Grove Blvd	Signal	3,600	3,737	103.8%	7.1	1.0	A
9	SR-65 NB Ramps/Pleasant Grove Blvd	Signal	2,730	2,791	102.2%	14.2	0.6	B
10	Stanford Ranch Rd/Five Star Blvd	Signal	2,835	2,942	103.8%	26.7	1.2	C
11	SR-65 NB Ramps/Stanford Ranch Rd	Signal	3,485	3,656	104.9%	15.2	4.1	B
12	SR-65 SB Ramps/Galleria Blvd	Signal	3,815	3,995	104.7%	16.7	1.0	B
13	Galleria Blvd/Antelope Creek Dr	Signal	2,926	3,087	105.5%	13.8	2.1	B
14	Galleria Blvd/Roseville Pkwy	Signal	5,131	5,514	107.5%	41.2	4.2	D
15	Creekside Ridge Dr/Roseville Pkwy	Signal	3,520	3,724	105.8%	7.8	1.6	A
16	Taylor Rd/East Roseville Pkwy	Signal	4,500	4,768	105.9%	48.9	4.9	D
17	North Sunrise Ave/East Roseville Pkwy	Signal	4,295	4,579	106.6%	28.1	3.6	C
18	Wills Rd/Atlantic St	Signal	1,990	2,201	110.6%	24.2	2.6	C
19	I-80 WB Ramps/Atlantic St	Signal	3,425	3,658	106.8%	14.7	2.4	B
20	Taylor Rd-I-80 EB Ramps/Eureka Rd	Signal	4,340	4,549	104.8%	25.0	4.5	C
21	North Sunrise Ave/Eureka Rd	Signal	3,955	4,138	104.6%	32.1	4.0	C
22	Harding Blvd/Wills Rd	Signal	355	364	102.4%	23.3	2.8	C
23	Harding Blvd/Douglas Blvd	Signal	2,680	2,858	106.7%	50.5	31.3	D
24	I-80 WB Ramps/Douglas Blvd	Signal	3,670	3,894	106.1%	22.9	5.7	C

Network Summary	
Total Demand Volume (veh/hr)	74,862
Total Volume Served (veh/hr)	79,396
Percent Served	106.1%

- Notes: 1. Volume is measured for the entire peak hour.
2. Delay is measured for the peak 15 minutes in the peak hour.

VISSIM Post-Processor
Average Results from 10 Runs
Intersection Volume and Delay

SR 65 Widening
Construction Year - HOV Lane Alternative
AM Peak Hour

	Intersection	Control	Volume (vph)		Percent Served	Delay (sec/veh)		Level of Service
			Demand	Served		Average	Std. Dev.	
25	I-80 EB Ramps/Douglas Blvd	Signal	4,050	4,323	106.7%	20.0	9.5	B
26	North Sunrise Ave/Douglas Blvd	Signal	4,410	4,652	105.5%	33.4	2.5	C
27	Pacific St/Woodside Dr	Signal	1,700	1,872	110.1%	7.1	0.8	A
28	Pacific St/Sunset Blvd	Signal	2,485	2,739	110.2%	24.1	1.3	C
29	Granite Dr/Rocklin Rd	Signal	2,301	2,396	104.1%	16.8	1.3	B
30	I-80 WB Ramps/Rocklin Rd	Signal	2,555	2,672	104.6%	23.3	3.8	C
31	I-80 EB Ramps/Rocklin Rd	Signal	2,685	2,856	106.4%	41.6	11.0	D
32	Aguilar Rd/Rocklin Rd	Signal	1,925	2,062	107.1%	13.9	13.9	B
33	Lincoln Blvd/SR-65 NB Off-Ramp	Signal	1,805	1,970	109.2%	5.9	0.6	A
34	Lincoln Blvd/SR-65 SB On-Ramp	Signal	1,245	1,344	107.9%	21.1	1.7	C
35	SR-65 SB Ramps/Placer Pkwy	Signal	1,715	1,767	103.0%	8.6	0.7	A
36	SR-65 NB Ramps/Whitney Ranch Pkwy	Signal	1,625	1,738	107.0%	9.1	1.4	A
40	Galleria Blvd/Berry St	Signal	1,920	2,079	108.3%	10.7	1.7	B

Network Summary	
Total Demand Volume (veh/hr)	30,421
Total Volume Served (veh/hr)	32,469
Percent Served	106.7%

- Notes: 1. Volume is measured for the entire peak hour.
2. Delay is measured for the peak 15 minutes in the peak hour.

VISSIM Post-Processor
Average Results from 10 Runs
Intersection Volume and Delay

SR 65 Widening
Construction Year - HOV Lane Alternative
PM Peak Hour

	Intersection	Control	Volume (vph)		Percent Served	Delay (sec/veh)		Level of Service
			Demand	Served		Average	Std. Dev.	
1	Lincoln Blvd/Sterling Parkway	Signal	2,345	2,305	98.3%	9.4	0.7	A
2	SR-65 SB Ramps/Twelve Bridges Dr	Signal	1,100	1,063	96.7%	11.6	2.0	B
3	SR-65 NB Ramps/Twelve Bridges Dr	Signal	1,590	1,580	99.4%	10.8	0.9	B
4	SR-65 SB Ramps/Sunset Blvd	Signal	2,885	3,013	104.5%	5.9	0.5	A
5	SR-65 NB Ramps/Sunset Blvd	Signal	2,860	2,967	103.7%	12.8	2.8	B
6	SR-65 SB Ramps-Washington Blvd/Blue Oaks Blvd	Signal	5,505	5,718	103.9%	46.5	7.0	D
7	SR-65 NB Ramps/Blue Oaks Blvd	Signal	4,040	4,165	103.1%	14.9	1.3	B
8	SR-65 SB Ramps/Pleasant Grove Blvd	Signal	5,095	5,055	99.2%	31.4	16.6	C
9	SR-65 NB Ramps/Pleasant Grove Blvd	Signal	4,235	4,212	99.5%	23.8	19.2	C
10	Stanford Ranch Rd/Five Star Blvd	Signal	4,345	4,380	100.8%	92.2	10.9	F
11	SR-65 NB Ramps/Stanford Ranch Rd	Signal	5,620	5,687	101.2%	23.2	13.4	C
12	SR-65 SB Ramps/Galleria Blvd	Signal	5,645	5,726	101.4%	16.3	2.8	B
13	Galleria Blvd/Antelope Creek Dr	Signal	4,690	4,590	97.9%	23.1	4.3	C
14	Galleria Blvd/Roseville Pkwy	Signal	7,635	7,533	98.7%	60.6	6.0	E
15	Creekside Ridge Dr/Roseville Pkwy	Signal	4,695	4,647	99.0%	34.2	9.4	C
16	Taylor Rd/East Roseville Pkwy	Signal	5,895	5,869	99.6%	50.6	10.3	D
17	North Sunrise Ave/East Roseville Pkwy	Signal	5,415	5,516	101.9%	41.7	4.7	D
18	Wills Rd/Atlantic St	Signal	2,970	3,019	101.6%	39.0	6.2	D
19	I-80 WB Ramps/Atlantic St	Signal	4,505	4,587	101.8%	12.5	1.0	B
20	Taylor Rd-I-80 EB Ramps/Eureka Rd	Signal	5,660	5,707	100.8%	52.1	7.5	D
21	North Sunrise Ave/Eureka Rd	Signal	5,540	5,735	103.5%	43.8	3.6	D
22	Harding Blvd/Wills Rd	Signal	375	402	107.1%	26.4	3.6	C
23	Harding Blvd/Douglas Blvd	Signal	3,745	3,589	95.8%	77.0	38.3	E
24	I-80 WB Ramps/Douglas Blvd	Signal	4,500	4,458	99.1%	35.0	5.0	C

Network Summary	
Total Demand Volume (veh/hr)	100,890
Total Volume Served (veh/hr)	101,523
Percent Served	100.6%

- Notes: 1. Volume is measured for the entire peak hour.
2. Delay is measured for the peak 15 minutes in the peak hour.

VISSIM Post-Processor
Average Results from 10 Runs
Intersection Volume and Delay

SR 65 Widening
Construction Year - HOV Lane Alternative
PM Peak Hour

	Intersection	Control	Volume (vph)		Percent Served	Delay (sec/veh)		Level of Service
			Demand	Served		Average	Std. Dev.	
25	I-80 EB Ramps/Douglas Blvd	Signal	5,225	5,021	96.1%	40.5	14.4	D
26	North Sunrise Ave/Douglas Blvd	Signal	5,855	5,758	98.3%	53.9	16.1	D
27	Pacific St/Woodside Dr	Signal	2,235	2,174	97.2%	6.6	1.0	A
28	Pacific St/Sunset Blvd	Signal	3,460	3,413	98.6%	29.7	1.9	C
29	Granite Dr/Rocklin Rd	Signal	3,700	3,480	94.0%	129.6	5.9	F
30	I-80 WB Ramps/Rocklin Rd	Signal	3,785	3,677	97.2%	27.3	6.6	C
31	I-80 EB Ramps/Rocklin Rd	Signal	3,535	3,535	100.0%	56.5	27.4	E
32	Aguilar Rd/Rocklin Rd	Signal	2,400	2,417	100.7%	22.5	3.8	C
33	Lincoln Blvd/SR-65 NB Off-Ramp	Signal	2,205	2,167	98.3%	9.0	0.9	A
34	Lincoln Blvd/SR-65 SB On-Ramp	Signal	1,140	1,139	99.9%	23.0	5.4	C
35	SR-65 SB Ramps/Placer Pkwy	Signal	2,015	2,008	99.6%	8.9	0.5	A
36	SR-65 NB Ramps/Whitney Ranch Pkwy	Signal	2,025	2,024	99.9%	32.0	19.2	C
40	Galleria Blvd/Berry St	Signal	2,885	2,926	101.4%	9.9	1.5	A

Network Summary	
Total Demand Volume (veh/hr)	40,465
Total Volume Served (veh/hr)	39,736
Percent Served	98.2%

- Notes: 1. Volume is measured for the entire peak hour.
2. Delay is measured for the peak 15 minutes in the peak hour.

Intersection 2

SR-65 SB Ramps/Twelve Bridges Dr

Signalized

Direction	Movement	Storage (ft)	Average Queue (ft)		Maximum Queue (ft)		Exceeds Storage?
			Average	Std. Dev.	Average	Std. Dev.	
SB	Left Turn	440	19	7	104	14	NO
	Through						
	Right Turn	1,500	12	7	101	14	NO

Intersection 3

SR-65 NB Ramps/Twelve Bridges Dr

Signalized

Direction	Movement	Storage (ft)	Average Queue (ft)		Maximum Queue (ft)		Exceeds Storage?
			Average	Std. Dev.	Average	Std. Dev.	
NB	Left Turn	700	6	1	52	11	NO
	Through						
	Right Turn	1,500	6	1	52	11	NO

Intersection 4

SR-65 SB Ramps/Sunset Blvd

Signalized

Direction	Movement	Storage (ft)	Average Queue (ft)		Maximum Queue (ft)		Exceeds Storage?
			Average	Std. Dev.	Average	Std. Dev.	
SB	Left Turn	360	46	7	174	31	NO
	Through						
	Right Turn	1,330	48	7	176	31	NO

Intersection 5

SR-65 NB Ramps/Sunset Blvd

Signalized

Direction	Movement	Storage (ft)	Average Queue (ft)		Maximum Queue (ft)		Exceeds Storage?
			Average	Std. Dev.	Average	Std. Dev.	
NB	Left Turn	1,400	61	5	263	37	NO
	Through						
	Right Turn	1,400	9	2	90	25	NO

Note: The "Average Queue" is calculated on a time-step basis so that queues when the approach is green (zero length) are included in the average.

Intersection 6

SR-65 SB Ramps-Washington Blvd/Blue Oaks Blvd

Signalized

Direction	Movement	Storage (ft)	Average Queue (ft)		Maximum Queue (ft)		Exceeds Storage?
			Average	Std. Dev.	Average	Std. Dev.	
SB	Left Turn	200	23	4	109	27	NO
	Through	2,260	71	8	329	65	NO
	Right Turn	200	0	0	55	56	NO

Intersection 7

SR-65 NB Ramps/Blue Oaks Blvd

Signalized

Direction	Movement	Storage (ft)	Average Queue (ft)		Maximum Queue (ft)		Exceeds Storage?
			Average	Std. Dev.	Average	Std. Dev.	
NB	Left Turn	400	42	27	596	333	MAX
	Through						
	Right Turn	1,100	43	27	597	333	NO

Intersection 8

SR-65 SB Ramps/Pleasant Grove Blvd

Signalized

Direction	Movement	Storage (ft)	Average Queue (ft)		Maximum Queue (ft)		Exceeds Storage?
			Average	Std. Dev.	Average	Std. Dev.	
SB	Left Turn	430	25	6	154	31	NO
	Through						
	Right Turn	1,130	27	6	157	31	NO

Intersection 9

SR-65 NB Ramps/Pleasant Grove Blvd

Signalized

Direction	Movement	Storage (ft)	Average Queue (ft)		Maximum Queue (ft)		Exceeds Storage?
			Average	Std. Dev.	Average	Std. Dev.	
NB	Left Turn	1,420	36	1	143	24	NO
	Through						
	Right Turn	1,420	35	1	142	24	NO

Note: The "Average Queue" is calculated on a time-step basis so that queues when the approach is green (zero length) are included in the average.

Intersection 11

SR-65 NB Ramps/Stanford Ranch Rd

Signalized

Direction	Movement	Storage (ft)	Average Queue (ft)		Maximum Queue (ft)		Exceeds Storage?
			Average	Std. Dev.	Average	Std. Dev.	
EB	Left Turn						
	Through						
	Right Turn	1,800	0	0	20	21	NO
WB	Left Turn						
	Through						
	Right Turn	1,170	9	2	107	43	NO

Intersection 12

SR-65 SB Ramps/Galleria Blvd

Signalized

Direction	Movement	Storage (ft)	Average Queue (ft)		Maximum Queue (ft)		Exceeds Storage?
			Average	Std. Dev.	Average	Std. Dev.	
EB	Left Turn						
	Through						
	Right Turn	1,130	48	1	259	52	NO
WB	Left Turn						
	Through						
	Right Turn	1,780	1	0	46	35	NO

Intersection 19

I-80 WB Ramps/Atlantic St

Signalized

Direction	Movement	Storage (ft)	Average Queue (ft)		Maximum Queue (ft)		Exceeds Storage?
			Average	Std. Dev.	Average	Std. Dev.	
NB	Left Turn						
	Through						
	Right Turn	1,150	0	0	0	0	NO
SB	Left Turn						
	Through						
	Right Turn	1,430	0	0	2	6	NO

Note: The "Average Queue" is calculated on a time-step basis so that queues when the approach is green (zero length) are included in the average.

Intersection 20

Taylor Rd-I-80 EB Ramps/Eureka Rd

Signalized

Direction	Movement	Storage (ft)	Average Queue (ft)		Maximum Queue (ft)		Exceeds Storage?
			Average	Std. Dev.	Average	Std. Dev.	
NB	Left Turn	180	88	39	499	501	MAX
	Through	1,700	56	11	253	92	NO
	Right Turn	1,700	15	18	271	571	NO
SB	Left Turn	550	15	6	74	17	NO
	Through						
	Right Turn	550	70	6	309	51	NO
EB	Left Turn	1,120	29	4	106	16	NO
	Through	1,120	78	17	600	128	NO
	Right Turn	810	3	4	224	92	NO
WB	Left Turn						
	Through	1,370	36	3	286	53	NO
	Right Turn	280	0	0	0	0	NO

Intersection 24

I-80 WB Ramps/Douglas Blvd

Signalized

Direction	Movement	Storage (ft)	Average Queue (ft)		Maximum Queue (ft)		Exceeds Storage?
			Average	Std. Dev.	Average	Std. Dev.	
SB	Left Turn	1,530	65	66	339	123	NO
	Through	1,530	65	66	339	123	NO
	Right Turn	730	65	66	339	123	NO

Note: The "Average Queue" is calculated on a time-step basis so that queues when the approach is green (zero length) are included in the average.

Intersection 25

I-80 EB Ramps/Douglas Blvd

Signalized

Direction	Movement	Storage (ft)	Average Queue (ft)		Maximum Queue (ft)		Exceeds Storage?
			Average	Std. Dev.	Average	Std. Dev.	
NB	Left Turn						
	Through						
	Right Turn	1,400	0	0	9	30	NO
SB	Left Turn						
	Through						
	Right Turn	1,250	14	2	109	35	NO

Intersection 30

I-80 WB Ramps/Rocklin Rd

Signalized

Direction	Movement	Storage (ft)	Average Queue (ft)		Maximum Queue (ft)		Exceeds Storage?
			Average	Std. Dev.	Average	Std. Dev.	
SB	Left Turn	700	9	2	96	30	NO
	Through						
	Right Turn	1,230	13	3	110	30	NO

Intersection 31

I-80 EB Ramps/Rocklin Rd

Signalized

Direction	Movement	Storage (ft)	Average Queue (ft)		Maximum Queue (ft)		Exceeds Storage?
			Average	Std. Dev.	Average	Std. Dev.	
NB	Left Turn	1,080	73	9	299	33	NO
	Through						
	Right Turn	1,080	71	9	296	33	NO

Note: The "Average Queue" is calculated on a time-step basis so that queues when the approach is green (zero length) are included in the average.

Intersection 33

Lincoln Blvd/SR-65 NB Off-Ramp

Signalized

Direction	Movement	Storage (ft)	Average Queue (ft)		Maximum Queue (ft)		Exceeds Storage?
			Average	Std. Dev.	Average	Std. Dev.	
WB	Left Turn	1,940	0	0	0	0	NO
	Through						
	Right Turn	1,940	0	0	0	0	NO

Intersection 35

SR-65 SB Ramps/Placer Pkwy

Signalized

Direction	Movement	Storage (ft)	Average Queue (ft)		Maximum Queue (ft)		Exceeds Storage?
			Average	Std. Dev.	Average	Std. Dev.	
SB	Left Turn	1,650	30	6	189	46	NO
	Through						
	Right Turn	1,650	30	6	189	46	NO

Intersection 36

SR-65 NB Ramps/Whitney Ranch Pkwy

Signalized

Direction	Movement	Storage (ft)	Average Queue (ft)		Maximum Queue (ft)		Exceeds Storage?
			Average	Std. Dev.	Average	Std. Dev.	
NB	Left Turn	1,620	23	3	144	26	NO
	Through						
	Right Turn	1,620	23	3	144	26	NO

Note: The "Average Queue" is calculated on a time-step basis so that queues when the approach is green (zero length) are included in the average.

Intersection 2

SR-65 SB Ramps/Twelve Bridges Dr

Signalized

Direction	Movement	Storage (ft)	Average Queue (ft)		Maximum Queue (ft)		Exceeds Storage?
			Average	Std. Dev.	Average	Std. Dev.	
SB	Left Turn	440	19	3	80	18	NO
	Through						
	Right Turn	1,500	12	3	77	18	NO

Intersection 3

SR-65 NB Ramps/Twelve Bridges Dr

Signalized

Direction	Movement	Storage (ft)	Average Queue (ft)		Maximum Queue (ft)		Exceeds Storage?
			Average	Std. Dev.	Average	Std. Dev.	
NB	Left Turn	700	18	1	98	30	NO
	Through						
	Right Turn	1,500	18	1	98	30	NO

Intersection 4

SR-65 SB Ramps/Sunset Blvd

Signalized

Direction	Movement	Storage (ft)	Average Queue (ft)		Maximum Queue (ft)		Exceeds Storage?
			Average	Std. Dev.	Average	Std. Dev.	
SB	Left Turn	360	30	2	123	32	NO
	Through						
	Right Turn	1,330	31	2	125	32	NO

Intersection 5

SR-65 NB Ramps/Sunset Blvd

Signalized

Direction	Movement	Storage (ft)	Average Queue (ft)		Maximum Queue (ft)		Exceeds Storage?
			Average	Std. Dev.	Average	Std. Dev.	
NB	Left Turn	1,400	51	4	204	28	NO
	Through						
	Right Turn	1,400	9	1	74	18	NO

Note: The "Average Queue" is calculated on a time-step basis so that queues when the approach is green (zero length) are included in the average.

Intersection 6

SR-65 SB Ramps-Washington Blvd/Blue Oaks Blvd

Signalized

Direction	Movement	Storage (ft)	Average Queue (ft)		Maximum Queue (ft)		Exceeds Storage?
			Average	Std. Dev.	Average	Std. Dev.	
SB	Left Turn	200	50	6	186	56	NO
	Through	2,260	56	9	234	38	NO
	Right Turn	200	0	0	3	10	NO

Intersection 7

SR-65 NB Ramps/Blue Oaks Blvd

Signalized

Direction	Movement	Storage (ft)	Average Queue (ft)		Maximum Queue (ft)		Exceeds Storage?
			Average	Std. Dev.	Average	Std. Dev.	
NB	Left Turn	400	47	15	515	196	MAX
	Through						
	Right Turn	1,100	48	15	516	196	NO

Intersection 8

SR-65 SB Ramps/Pleasant Grove Blvd

Signalized

Direction	Movement	Storage (ft)	Average Queue (ft)		Maximum Queue (ft)		Exceeds Storage?
			Average	Std. Dev.	Average	Std. Dev.	
SB	Left Turn	430	25	3	125	29	NO
	Through						
	Right Turn	1,130	27	3	127	29	NO

Intersection 9

SR-65 NB Ramps/Pleasant Grove Blvd

Signalized

Direction	Movement	Storage (ft)	Average Queue (ft)		Maximum Queue (ft)		Exceeds Storage?
			Average	Std. Dev.	Average	Std. Dev.	
NB	Left Turn	1,420	47	3	182	45	NO
	Through						
	Right Turn	1,420	46	3	181	45	NO

Note: The "Average Queue" is calculated on a time-step basis so that queues when the approach is green (zero length) are included in the average.

Intersection 11

SR-65 NB Ramps/Stanford Ranch Rd

Signalized

Direction	Movement	Storage (ft)	Average Queue (ft)		Maximum Queue (ft)		Exceeds Storage?
			Average	Std. Dev.	Average	Std. Dev.	
EB	Left Turn						
	Through						
	Right Turn	1,800	0	0	18	23	NO
WB	Left Turn						
	Through						
	Right Turn	1,170	95	45	350	328	NO

Intersection 12

SR-65 SB Ramps/Galleria Blvd

Signalized

Direction	Movement	Storage (ft)	Average Queue (ft)		Maximum Queue (ft)		Exceeds Storage?
			Average	Std. Dev.	Average	Std. Dev.	
EB	Left Turn						
	Through						
	Right Turn	1,130	50	3	240	18	NO
WB	Left Turn						
	Through						
	Right Turn	1,780	7	2	142	35	NO

Intersection 19

I-80 WB Ramps/Atlantic St

Signalized

Direction	Movement	Storage (ft)	Average Queue (ft)		Maximum Queue (ft)		Exceeds Storage?
			Average	Std. Dev.	Average	Std. Dev.	
NB	Left Turn						
	Through						
	Right Turn	1,150	0	0	0	0	NO
SB	Left Turn						
	Through						
	Right Turn	1,430	0	0	34	42	NO

Note: The "Average Queue" is calculated on a time-step basis so that queues when the approach is green (zero length) are included in the average.

Intersection 20

Taylor Rd-I-80 EB Ramps/Eureka Rd

Signalized

Direction	Movement	Storage (ft)	Average Queue (ft)		Maximum Queue (ft)		Exceeds Storage?
			Average	Std. Dev.	Average	Std. Dev.	
NB	Left Turn	180	236	101	1,111	517	AVG
	Through	1,700	85	9	467	507	NO
	Right Turn	1,700	96	91	904	630	NO
SB	Left Turn	550	21	5	99	30	NO
	Through						
	Right Turn	550	210	105	748	78	MAX
EB	Left Turn	1,120	33	15	172	53	NO
	Through	1,120	121	8	586	123	NO
	Right Turn	810	7	2	209	88	NO
WB	Left Turn						
	Through	1,370	177	24	720	176	NO
	Right Turn	280	35	13	356	176	MAX

Intersection 24

I-80 WB Ramps/Douglas Blvd

Signalized

Direction	Movement	Storage (ft)	Average Queue (ft)		Maximum Queue (ft)		Exceeds Storage?
			Average	Std. Dev.	Average	Std. Dev.	
SB	Left Turn	1,530	67	67	325	73	NO
	Through	1,530	67	67	325	73	NO
	Right Turn	730	67	67	325	73	NO

Note: The "Average Queue" is calculated on a time-step basis so that queues when the approach is green (zero length) are included in the average.

Intersection 25

I-80 EB Ramps/Douglas Blvd

Signalized

Direction	Movement	Storage (ft)	Average Queue (ft)		Maximum Queue (ft)		Exceeds Storage?
			Average	Std. Dev.	Average	Std. Dev.	
NB	Left Turn						
	Through						
	Right Turn	1,400	0	1	41	129	NO
SB	Left Turn						
	Through						
	Right Turn	1,250	199	157	1,087	580	NO

Intersection 30

I-80 WB Ramps/Rocklin Rd

Signalized

Direction	Movement	Storage (ft)	Average Queue (ft)		Maximum Queue (ft)		Exceeds Storage?
			Average	Std. Dev.	Average	Std. Dev.	
SB	Left Turn	700	25	3	179	44	NO
	Through						
	Right Turn	1,230	34	4	194	44	NO

Intersection 31

I-80 EB Ramps/Rocklin Rd

Signalized

Direction	Movement	Storage (ft)	Average Queue (ft)		Maximum Queue (ft)		Exceeds Storage?
			Average	Std. Dev.	Average	Std. Dev.	
NB	Left Turn	1,080	312	123	913	523	NO
	Through						
	Right Turn	1,080	309	122	910	523	NO

Note: The "Average Queue" is calculated on a time-step basis so that queues when the approach is green (zero length) are included in the average.

Intersection 33

Lincoln Blvd/SR-65 NB Off-Ramp

Signalized

Direction	Movement	Storage (ft)	Average Queue (ft)		Maximum Queue (ft)		Exceeds Storage?
			Average	Std. Dev.	Average	Std. Dev.	
WB	Left Turn	1,940	0	0	0	0	NO
	Through						
	Right Turn	1,940	0	0	6	13	NO

Intersection 35

SR-65 SB Ramps/Placer Pkwy

Signalized

Direction	Movement	Storage (ft)	Average Queue (ft)		Maximum Queue (ft)		Exceeds Storage?
			Average	Std. Dev.	Average	Std. Dev.	
SB	Left Turn	1,650	27	3	140	24	NO
	Through						
	Right Turn	1,650	27	3	140	24	NO

Intersection 36

SR-65 NB Ramps/Whitney Ranch Pkwy

Signalized

Direction	Movement	Storage (ft)	Average Queue (ft)		Maximum Queue (ft)		Exceeds Storage?
			Average	Std. Dev.	Average	Std. Dev.	
NB	Left Turn	1,620	35	3	182	22	NO
	Through						
	Right Turn	1,620	35	3	182	22	NO

Note: The "Average Queue" is calculated on a time-step basis so that queues when the approach is green (zero length) are included in the average.

SR 65 Capacity and Operational Improvements

**Vissim Model Results – Construction Year
Alternative 2 (General Purpose Lane)**

VISSIM Post-Processor
Average Values from 10 Runs
Network Statistics

SR 65 Widening
Construction Year - GP Alternative
AM Peak Period

Network Performance	Vehicle Types	Average	Std. Dev.
Number of Vehicles Served	All Vehicles	167,506	48
Travel Distance [mi]	All Vehicles	797,356	1,082
Travel Time [h]	All Vehicles	18,004	145.9
Average Speed [mph]	All Vehicles	44.3	0.3
Total Delay [h]	All Vehicles	4,329	141.3
Average Delay per Vehicle [s]	All Vehicles	91	3.0
VHD/VMT [min/mile]	All Vehicles	0.33	0.01
Number of Vehicles Served	HOV	32,234	24
Travel Distance [mi]	HOV	163,532	503
Travel Time [h]	HOV	3,508	19
Average Speed [mph]	HOV	46.6	0.3
Total Delay [h]	HOV	730	21
Average Delay per Vehicle [s]	HOV	79	2
VHD/VMT [min/mile]	HOV	0.27	0.01
Number of Vehicles Served	Truck	7,509	9
Travel Distance [mi]	Truck	38,735	382
Travel Time [h]	Truck	900	12
Average Speed [mph]	Truck	43.0	0
Total Delay [h]	Truck	230	9
Average Delay per Vehicle [s]	Truck	108	4
VHD/VMT [min/mile]	Truck	0.36	0.01

Performance Measure	Vehicle Types		
	HOV	Truck	All
Vehicles Served	32,230	7,510	167,510
Demand Volume	33,370	8,090	169,340
Percent Demand Served	96.6%	92.8%	98.9%
Vehicle Miles of Travel	163,530	38,740	797,360
Person Miles of Travel	343,420	40,670	979,180
Vehicle Hours of Travel	3,510	900	18,000
Vehicle Hours of Delay	730	230	4,330
VHD % of VHT	20.8%	25.6%	24.1%
Average Delay per Vehicle (min)	1.36	1.84	1.55
Person Hours of Delay	1,530	240	5,140
Average Travel Speed	46.6	43.0	44.3

VISSIM Post-Processor
Average Values from 10 Runs
Peak Hour Travel Time

SR 65 Widening
Construction Year - GP Alternative
AM Peak Period

Mode	Description	Distance (ft)	Volume (vehicles)		Travel Time (min.:sec.)		Speed (mph)
			Average	Std. Dev.	Average	Std. Dev.	Average
SOV	SR-65 at Blue Oaks to I-80 at Antelope	43,101	843	12	08:50	00:22	22.2
	I-80 at Auburn to SR-65 at Blue Oaks	32,869	1,588	18	07:04	00:02	21.1
	I-80: Sierra College to Antelope	45,827	1,134	16	08:42	00:20	24.0
	I-80: Auburn to Sierra College	36,777	662	14	06:37	00:01	25.2
	SR-65: I-80 to Sunset	43,111	637	13	04:17	00:00	45.8
	SR-65: Sunset to Ferrari Ranch	45,816	169	6	03:31	00:01	59.3
	SR-65: Ferrari Ranch to Sunset	36,773	1,052	12	03:48	00:10	43.9
	SR-65: Sunset to I-80	32,869	1,269	14	04:21	00:05	34.3
HOV	SR-65 at Blue Oaks to I-80 at Antelope	43,101	364	8	08:33	00:12	45.8
	I-80 at Auburn to SR-65 at Blue Oaks	32,869	430	7	07:01	00:02	59.3
	I-80: Sierra College to Antelope	45,827	498	10	08:20	00:05	43.9
	I-80: Auburn to Sierra College	36,777	230	6	06:33	00:01	34.3
	SR-65: I-80 to Sunset	43,111	158	7	04:16	00:01	22.9
	SR-65: Sunset to Ferrari Ranch	45,816	32	3	03:28	00:18	21.3
	SR-65: Ferrari Ranch to Sunset	36,773	122	5	03:48	00:11	25.0
	SR-65: Sunset to I-80	32,869	407	10	04:21	00:06	25.5

VISSIM Post-Processor
Average Values from 10 Runs
Network Statistics

SR 65 Widening
Construction Year - GP Alternative
PM Peak Period

Network Performance	Vehicle Types	Average	Std. Dev.
Number of Vehicles Served	All Vehicles	232,112	704
Travel Distance [mi]	All Vehicles	930,143	3,315
Travel Time [h]	All Vehicles	25,886	332.5
Average Speed [mph]	All Vehicles	35.9	0.4
Total Delay [h]	All Vehicles	9,523	313.0
Average Delay per Vehicle [s]	All Vehicles	145	4.6
VHD/VMT [min/mile]	All Vehicles	0.61	0.02
Number of Vehicles Served	HOV	45,803	178
Travel Distance [mi]	HOV	198,328	1,126
Travel Time [h]	HOV	4,985	36
Average Speed [mph]	HOV	39.8	0.3
Total Delay [h]	HOV	1,532	35
Average Delay per Vehicle [s]	HOV	118	3
VHD/VMT [min/mile]	HOV	0.46	0.01
Number of Vehicles Served	Truck	9,009	37
Travel Distance [mi]	Truck	37,964	214
Travel Time [h]	Truck	1,138	28
Average Speed [mph]	Truck	33.4	1
Total Delay [h]	Truck	465	29
Average Delay per Vehicle [s]	Truck	181	11
VHD/VMT [min/mile]	Truck	0.74	0.05

Performance Measure	Vehicle Types		
	HOV	Truck	All
Vehicles Served	45,800	9,010	232,110
Demand Volume	46,890	9,660	233,410
Percent Demand Served	97.7%	93.3%	99.4%
Vehicle Miles of Travel	198,330	37,960	930,140
Person Miles of Travel	416,490	39,860	1,150,200
Vehicle Hours of Travel	4,990	1,140	25,890
Vehicle Hours of Delay	1,530	470	9,520
VHD % of VHT	30.7%	41.2%	36.8%
Average Delay per Vehicle (min)	2.00	3.13	2.46
Person Hours of Delay	3,210	490	11,220
Average Travel Speed	39.8	33.4	35.9

VISSIM Post-Processor
Average Values from 10 Runs
Peak Hour Travel Time

SR 65 Widening
Construction Year - GP Alternative
PM Peak Period

Mode	Description	Distance (ft)	Volume (vehicles)		Travel Time (min.:sec.)		Speed (mph)
			Average	Std. Dev.	Average	Std. Dev.	Average
SOV	SR-65 at Blue Oaks to I-80 at Antelope	43,102	662	13	08:15	00:01	23.7
	I-80 at Auburn to SR-65 at Blue Oaks	32,867	1,276	15	14:05	01:29	10.6
	I-80: Sierra College to Antelope	45,827	506	8	08:15	00:01	25.2
	I-80: Auburn to Sierra College	36,777	714	13	12:52	01:29	13.0
	SR-65: I-80 to Sunset	43,111	1,267	16	04:25	00:07	44.4
	SR-65: Sunset to Ferrari Ranch	45,816	326	8	03:34	00:00	58.3
	SR-65: Ferrari Ranch to Sunset	36,773	684	11	03:31	00:00	47.6
	SR-65: Sunset to I-80	32,867	847	13	04:09	00:00	36.0
HOV	SR-65 at Blue Oaks to I-80 at Antelope	43,102	282	7	08:13	00:01	44.4
	I-80 at Auburn to SR-65 at Blue Oaks	32,867	644	8	09:09	00:26	58.3
	I-80: Sierra College to Antelope	45,827	199	6	08:09	00:02	47.6
	I-80: Auburn to Sierra College	36,777	285	6	07:36	00:21	36.0
	SR-65: I-80 to Sunset	43,111	409	10	04:25	00:07	23.9
	SR-65: Sunset to Ferrari Ranch	45,816	64	4	03:34	00:02	16.3
	SR-65: Ferrari Ranch to Sunset	36,773	104	4	03:31	00:01	25.6
	SR-65: Sunset to I-80	32,867	217	9	04:09	00:01	22.0

VISSIM Post-Processor
Average Results from 10 Runs
Freeway Operations Summary

SR 65 Widening
Construction Year - GP Alternative
AM Peak Hour

Location	Facility Type	Mainline Volume (vph)			On-ramp Volume (vph)			Off-ramp Volume (vph)			Speed (mph)		Density (vplpm)		LOS
		Avg.	St. Dev.	%	Avg.	St. Dev.	%	Avg.	St. Dev.	%	Avg.	St. Dev.	Avg.	St. Dev.	
1 I-80 EB - Auburn Blvd On-ramp	Merge	7,228	34	110.3%	1,023	18	110.0%				62.1	0.4	28.4	0.6	D
2 I-80 EB - Auburn Blvd to Douglas Blvd	Basic	8,238	64	110.1%							58.3	1.4	35.2	1.0	E
3 I-80 EB - Douglas Blvd Slip Off	Diverge	8,227	80	110.0%				1,434	89	110.3%	60.5	1.1	29.5	0.7	D
4 I-80 EB - Douglas Blvd WB Off-ramp	Diverge	6,790	106	109.9%				514	49	109.4%	62.7	0.8	23.1	0.3	C
5 I-80 EB - Douglas Blvd Off to On-ramp	Basic	6,277	100	109.9%							63.2	0.1	25.2	0.3	C
6 I-80 EB - Douglas Blvd On-ramp	Merge	6,273	102	109.9%	866	31	95.2%				62.3	0.3	28.3	0.8	D
7 I-80 EB - Eureka Rd Off-ramp	Diverge	7,141	105	107.9%							61.7	0.5	29.6	0.9	D
8 I-80 EB - Eureka Rd Off to On-ramp	Basic	5,783	107	108.1%							63.1	0.3	24.9	0.4	C
9 I-80 EB - Eureka Rd EB On-ramp	Merge	5,783	109	108.1%	184	4	96.6%				63.1	0.1	23.1	0.3	C
10 I-80 EB - Eureka Rd to Taylor Rd	Weave	5,969	107	107.7%	438	31	101.8%	368	40	105.1%	62.7	0.1	25.2	0.4	C
11 I-80 EB - Taylor Rd to SR 65	Basic	6,035	114	107.4%							59.7	1.2	31.6	0.8	D
17 I-80 EB - SR 65 Off-ramp	Diverge	6,035	110	107.4%				3,196	102	107.6%	60.6	1.0	32.1	0.9	D
18 I-80 EB - SR 65 Off to On-ramp	Basic	2,838	82	107.1%							63.9	0.1	15.8	0.5	B
19 I-80 EB - SR-65 On-ramp	Merge	2,839	88	107.1%	1,557	74	108.1%				62.4	0.8	23.3	0.7	C
21 I-80 EB - SR-65 to Rocklin Rd	Basic	4,403	132	107.7%							63.3	0.2	21.8	0.5	C
22 I-80 EB - Rocklin Rd Off-ramp	Diverge	4,405	124	107.7%				1,511	73	105.7%	63.5	0.2	21.2	0.5	C
23 I-80 EB - Rocklin Rd Off to On-ramp	Basic	2,901	101	109.0%							63.7	0.2	18.1	0.7	C
24 I-80 EB - Rocklin Rd On-ramp	Merge	2,902	99	109.1%	176	5	92.8%				61.6	0.4	18.2	0.7	B
25 I-80 EB - Rocklin Rd to Sierra College Blvd	Basic	3,084	106	108.2%							63.4	0.3	18.9	0.7	C
26 I-80 EB - Sierra College Blvd Off-ramp	Diverge	3,084	107	108.2%				418	43	107.1%	62.7	0.5	20.0	0.7	C
27 I-80 EB - Sierra College Blvd Off to On-ramp	Basic	2,670	95	108.5%							63.6	0.2	17.3	0.7	B
28 I-80 EB - Sierra College Blvd SB On-ramp	Merge	2,672	97	108.6%	132	6	101.4%				62.8	0.3	16.2	0.5	B
29 I-80 EB - Sierra College Blvd NB On-ramp	Merge	2,805	90	108.3%	417	14	109.8%				62.4	0.3	18.0	0.5	B
38 I-80 WB - Sierra College Blvd Off-ramp	Diverge	4,877	16	105.8%				856	55	107.0%	56.6	2.0	27.9	1.2	C
39 I-80 WB - Sierra College Blvd Off to On-ramp	Basic	4,018	71	105.5%							62.1	0.4	24.5	0.3	C
40 I-80 WB - Sierra College Blvd NB On-ramp	Merge	4,018	73	105.5%	58	4	96.7%				63.0	0.2	21.9	0.6	C
41 I-80 WB - Sierra College Blvd SB On-ramp	Merge	4,076	78	105.3%	309	10	103.0%				61.1	0.9	23.8	0.7	C
42 I-80 WB - Sierra College Blvd to Rocklin Rd	Basic	4,385	91	105.2%							62.3	0.5	26.4	0.6	D
43 I-80 WB - Rocklin Rd Off-ramp	Diverge	4,386	91	105.2%				225	27	102.1%	61.2	1.3	27.2	0.9	C
44 I-80 WB - Rocklin Rd Off to On-ramp	Basic	4,161	92	105.3%							62.9	0.5	24.6	0.4	C
45 I-80 WB - Rocklin Rd On-ramp	Merge	4,162	99	105.4%	904	45	101.6%				60.6	0.8	26.4	0.9	C
46 I-80 WB - Rocklin Rd to HOV Lane Start	Basic	5,067	115	104.7%							62.2	0.5	28.4	0.8	D
47 I-80 WB - HOV Lane Start to SR-65	Basic	5,059	116	104.5%							62.2	0.3	23.8	0.5	C
48 I-80 WB - SR-65 Off-ramp	Diverge	5,059	114	104.5%				1,461	68	105.1%	63.6	0.2	21.9	0.5	C
49 I-80 WB - SR-65 Off to On-ramp	Basic	3,588	91	104.0%							63.7	0.1	19.5	0.5	C
50 I-80 WB - SR-65 On-ramp	Merge	3,586	91	103.9%	3,874	116	105.6%				60.6	0.4	29.8	0.7	D
60 I-80 WB - Taylor Rd On-ramp	Merge	7,454	126	104.7%	618	43	108.5%				55.7	3.0	37.7	2.6	E
61 I-80 WB - Atlantic St WB Off-ramp	Diverge	8,071	115	105.0%				333	33	104.2%	58.5	2.3	37.0	1.9	E
62 I-80 WB - Atlantic St EB Off-ramp	Diverge	7,733	109	104.9%				1,003	56	102.3%	59.6	2.1	36.0	1.4	E
63 I-80 WB - Atlantic St EB Off to On-ramp	Basic	6,729	98	105.3%							62.7	0.3	27.2	0.3	D
64 I-80 WB - Atlantic St On-ramp	Merge	6,728	106	105.3%	1,151	68	105.6%				56.9	3.3	37.1	2.1	E
65 I-80 WB - Douglas Blvd Off-ramp	Diverge	7,872	129	105.2%				966	71	102.7%	59.6	0.5	33.2	0.8	D
66 I-80 WB - Douglas Blvd Off to On-ramp	Basic	6,914	116	105.7%							62.7	0.2	28.7	0.4	D
67 I-80 WB - Douglas Blvd WB On-ramp	Merge	6,914	119	105.7%	1,020	40	107.4%				57.7	4.8	32.0	4.5	D
68 I-80 WB - Douglas Blvd Slip On	Merge	7,939	104	106.0%	462	32	107.5%				56.4	6.3	36.9	5.9	E
69 I-80 WB - Douglas Blvd to Riverside Ave	Basic	8,404	130	106.1%							61.8	0.3	33.7	0.6	D
70 I-80 WB - Riverside Ave Off-ramp	Diverge	8,406	125	106.1%				913	65	99.2%	62.4	0.2	33.3	0.7	D
71 I-80 WB - Riverside Ave Off to On-ramp	Basic	7,499	131	107.1%							62.7	0.2	29.9	0.6	D
72 I-80 WB - Riverside Ave NB On-ramp	Merge	7,499	133	107.1%	286	7	84.1%				63.0	0.2	28.0	0.8	D
73 I-80 WB - Riverside Ave SB On-ramp	Merge	7,791	143	106.1%	814	13	99.3%				61.0	4.4	35.4	3.8	E
74 I-80 WB - Riverside Ave to Antelope Rd	Basic	8,605	164	105.4%							51.9	13.7	44.4	18.0	E
75 I-80 WB - Antelope Rd Off-ramp	Diverge	8,608	188	105.5%				340	28	89.4%	45.3	13.7	52.6	18.4	F
76 I-80 WB - Antelope Rd Off to On-ramp	Basic	8,274	240	106.3%							36.2	10.4	64.7	19.1	F
77 I-80 WB - Antelope Rd WB On-ramp	Merge	8,278	253	106.4%	565	12	97.4%				30.5	10.9	84.5	20.4	F
78 I-80 WB - Antelope Rd to Truck Scales	Weave	8,869	225	106.1%	445	12	96.7%	91	14	82.3%	31.3	3.4	73.3	7.1	F
79 I-80 WB - Truck Scales Off to On-ramp	Basic	9,323	270	107.0%							29.2	1.4	83.3	5.5	F
80 I-80 WB - Truck Scales On-ramp	Merge	9,368	244	107.6%	91	14	82.8%				28.8	0.5	94.0	2.6	F
81 I-80 WB - Truck Scales to Elkhorn Blvd	Basic	9,540	244	108.2%							33.3	1.9	70.6	4.2	F
82 I-80 WB - Elkhorn Blvd Off-ramp	Diverge	9,553	237	108.3%				817	58	110.4%	33.6	1.2	58.5	2.9	F
83 I-80 WB - Elkhorn Blvd Off to On-ramp	Basic	8,812	163	109.1%							26.3	0.3	92.7	1.7	F
84 I-80 WB - Elkhorn Blvd WB On-ramp	Merge	8,836	157	109.4%	801	11	95.4%				26.6	0.4	95.5	2.1	F
85 I-80 WB - Elkhorn Blvd EB On-ramp	Merge	9,660	148	108.3%	876	21	95.2%				32.6	0.5	76.6	1.5	F

Notes: Average density reported for the analysis area only: for example, within the ramp influence area and not including the HOV lane.
Mainline volume is the upstream served volume for all lanes.

VISSIM Post-Processor
 Average Results from 10 Runs
 Freeway Operations Summary

SR 65 Widening
 Construction Year - GP Alternative
 AM Peak Hour

Location	Facility Type	Mainline Volume (vph)			On-ramp Volume (vph)			Off-ramp Volume (vph)			Speed (mph)		Density (vplpm)		LOS
		Avg.	St. Dev.	%	Avg.	St. Dev.	%	Avg.	St. Dev.	%	Avg.	St. Dev.	Avg.	St. Dev.	
100 SR-65 NB - EB I-80 Connector	Basic	3,198	101	107.7%							40.9	1.3	46.8	2.7	F
101 SR-65 NB - WB I-80 Connector	Basic	1,460	68	105.0%							51.2	0.4	23.5	1.3	C
103 SR-65 NB - I-80 WB On-ramp	Merge	3,199	98	107.7%	1,459	67	105.0%				61.0	0.5	28.7	0.7	D
104 SR-65 NB - I-80 to Stanford Ranch Rd	Basic	4,656	120	106.8%							63.1	0.3	27.4	0.8	D
105 SR-65 NB - Stanford Ranch Rd Off to On-ramp	Diverge	4,656	117	106.8%				711	44	106.0%	62.8	0.6	23.8	1.1	C
106 SR-65 NB - Stanford Ranch Rd Off-ramp	Basic	3,946	124	106.9%							63.1	0.4	23.5	0.7	C
107 SR-65 NB - Stanford Ranch Rd to Pleasant Grove Blvd	Weave	3,948	121	107.0%	904	40	108.9%	637	52	101.1%	62.6	0.2	23.9	0.6	C
110 SR-65 NB - Pleasant Grove Blvd Off to On-ramp	Basic	4,213	91	108.3%							62.9	0.1	25.1	0.5	C
111 SR-65 NB - Pleasant Grove Blvd On-ramp	Merge	4,213	92	108.3%	238	27	99.1%				60.4	0.9	33.2	0.8	D
112 SR-65 NB - Blue Oaks Blvd Off-ramp	Diverge	4,451	93	107.8%				1,960	77	108.3%	62.2	0.4	26.8	0.7	C
114 SR-65 NB - Blue Oaks Blvd Off to On-ramp	Basic	2,490	89	107.3%							63.3	0.2	21.7	0.7	C
115 SR-65 NB - Blue Oaks Blvd On-ramp	Merge	2,493	90	107.4%	516	40	99.2%				62.7	0.1	18.8	0.6	B
116 SR-65 NB - Blue Oaks Blvd to Sunset Blvd	Basic	3,008	89	105.9%							63.4	0.2	18.6	0.4	C
118 SR-65 NB - Sunset Blvd Off-ramp	Diverge	3,010	90	106.0%				1,299	59	106.4%	63.6	0.2	18.3	0.5	B
119 SR-65 NB - Sunset Blvd Off to On-ramp	Basic	1,709	89	105.5%							63.7	0.2	14.5	0.6	B
120 SR-65 NB - Sunset Blvd EB On-ramp	Merge	1,710	86	105.6%	51	11	101.8%				63.7	0.3	14.5	0.6	B
121 SR-65 NB - Sunset Blvd to Whitney Ranch Pkwy	Weave	1,763	88	105.5%	157	14	104.8%	355	41	98.6%	63.6	0.2	13.8	0.7	B
124 SR-65 NB - Whitney Ranch Pkwy Off to On-ramp	Basic	1,570	96	107.5%							63.7	0.2	13.4	0.8	B
125 SR-65 NB - Whitney Ranch Pkwy EB On-ramp	Merge	1,570	98	107.6%	188	12	98.9%				63.0	0.4	14.1	0.6	B
126 SR-65 NB - Whitney Ranch Pkwy to Twelve Bridges Dr	Weave	1,757	95	106.5%	206	17	108.4%	415	39	96.4%	63.8	0.2	12.7	0.5	B
129 SR-65 NB - Twelve Bridges Dr Off to On-ramp	Basic	1,554	81	110.2%							63.8	0.2	14.0	0.6	B
130 SR-65 NB - Twelve Bridges Dr to Lincoln Blvd	Weave	1,557	82	110.4%	262	29	104.6%	650	52	114.0%	63.8	0.3	12.6	0.7	B
133 SR-65 NB - Lincoln Blvd to Ferrari Ranch Rd	Basic	1,169	75	107.2%							64.1	0.1	12.6	0.8	B
134 SR-65 NB - Ferrari Ranch Rd Off-ramp	Diverge	1,169	76	107.3%				695	70	106.9%	64.4	0.1	10.5	0.5	B
135 SR-65 NB - Ferrari Ranch Rd Off to On-ramp	Basic	475	33	107.9%							64.6	0.3	4.6	0.2	A
136 SR-65 NB - Ferrari Ranch Rd On-ramp	Merge	476	34	108.2%	114	7	104.0%				62.5	0.4	5.1	0.2	A
150 SR-65 SB - Ferrari Ranch Rd Off-ramp	Diverge	1,039	40	112.9%				80	15	114.3%	64.3	0.2	11.5	0.4	B
151 SR-65 SB - Ferrari Ranch Rd Off to On-ramp	Basic	959	40	112.8%							64.3	0.2	10.5	0.4	A
152 SR-65 SB - Ferrari Ranch Rd WB On-ramp	Merge	959	40	112.8%	898	18	108.2%				60.3	0.2	14.2	0.3	B
153 SR-65 SB - Ferrari Ranch Rd EB On-ramp	Merge	1,859	47	110.6%	708	23	93.1%				60.1	0.5	19.0	0.4	B
154 SR-65 SB - Ferrari Ranch Rd to Lane Drop	Basic	2,568	54	105.2%							62.5	0.5	27.1	0.6	D
155 SR-65 SB - Lane Drop to Lincoln Blvd	Basic	2,568	55	105.2%							62.9	0.4	26.9	0.6	D
156 SR-65 SB - Lincoln Blvd to Twelve Bridges Dr	Weave	2,569	57	105.3%	898	46	106.9%	323	33	107.7%	59.4	1.8	27.2	1.1	C
159 SR-65 SB - Twelve Bridges Dr Off to On-ramp	Basic	3,146	79	105.6%							61.5	1.0	30.7	1.0	D
160 SR-65 SB - Twelve Bridges Dr to Placer Pkwy	Weave	3,146	77	105.6%	866	38	113.9%	441	38	110.2%	61.2	0.2	28.2	0.6	D
163 SR-65 SB - Placer Pkwy Off to On-ramp	Basic	3,568	81	106.8%							59.1	0.6	33.8	1.2	D
164 SR-65 SB - Placer Pkwy WB On-ramp	Merge	3,567	80	106.8%	291	27	107.6%				58.7	5.5	35.0	4.2	E
165 SR-65 SB - Placer Pkwy to Sunset Blvd	Weave	3,857	84	106.8%	230	20	109.5%	465	49	101.0%	48.0	10.5	44.7	14.1	E
168 SR-65 SB - Sunset Blvd Off to On-ramp	Basic	3,626	97	107.9%							26.1	5.8	76.1	17.5	F
169 SR-65 SB - Sunset Blvd WB On-ramp	Merge	3,627	96	107.9%	615	33	111.8%				27.3	1.7	74.5	5.8	F
170 SR-65 SB - Sunset Blvd to Blue Oaks Blvd	Weave	4,240	108	108.4%	457	13	101.6%	909	52	108.2%	59.7	0.6	31.2	0.4	D
172 SR-65 SB - Blue Oaks Blvd Off to Lane Add	Basic	3,777	105	107.3%							62.0	0.1	32.4	0.7	D
173 SR-65 SB - Lane Add to Blue Oaks Blvd WB On-ramp	Basic	3,775	101	107.3%							62.7	0.1	27.8	0.4	D
174 SR-65 SB - Blue Oaks Blvd WB On-ramp	Merge	3,330	91	94.6%	529	20	105.7%				59.2	0.4	27.0	0.3	C
175 SR-65 SB - Blue Oaks Blvd WB to EB On-ramp	Basic	4,305	105	107.1%							63.5	0.3	24.4	0.3	C
176 SR-65 SB - Blue Oaks Blvd EB On-ramp	Merge	4,306	105	107.1%	1,195	44	103.0%				61.1	0.6	26.3	0.6	C
177 SR-65 SB - Pleasant Grove Blvd Off-ramp	Diverge	5,501	121	106.2%				680	39	104.6%	62.2	1.0	25.3	0.6	C
178 SR-65 SB - Pleasant Grove Blvd Off to On-ramp	Basic	4,822	122	106.4%							63.1	0.4	21.5	0.4	C
179 SR-65 SB - Pleasant Grove Blvd WB On-ramp	Merge	4,822	124	106.5%	436	35	101.4%				61.2	0.4	28.5	0.6	D
180 SR-65 SB - Pleasant Grove Blvd EB On-ramp	Merge	5,256	137	106.0%	626	38	102.7%				61.1	0.6	25.3	0.6	C
181 SR-65 SB - Pleasant Grove Blvd to Galleria Blvd	Basic	5,882	139	105.6%							62.4	0.3	27.8	0.6	D
182 SR-65 SB - Galleria Blvd Off-ramp	Diverge	5,882	137	105.6%				1,191	65	102.7%	62.9	0.2	27.3	0.6	C
183 SR-65 SB - Galleria Blvd Off to On-ramp	Basic	4,693	114	106.4%							60.2	0.8	31.2	0.7	D
185 SR-65 SB - Galleria Blvd On-ramp	Merge	4,697	121	106.5%	723	28	103.3%				53.7	10.7	41.8	13.4	E
186 SR-65 SB - I-80 Off-ramp	Diverge	5,425	138	106.2%				3,876	121	105.6%	59.2	0.9	34.3	1.0	D
187 SR-65 SB - EB I-80 Connector (2 lanes)	Basic	1,555	71	108.0%							59.2	1.2	30.4	1.9	D
188 SR-65 SB - EB I-80 Connector (1 lane)	Basic	1,556	78	108.1%							61.2	0.6	29.7	1.6	D
189 SR-65 SB - WB I-80 Connector	Basic	3,877	119	105.6%							51.6	0.3	39.9	1.2	E

Notes: Average density reported for the analysis area only: for example, within the ramp influence area and not including the HOV lane.
 Mainline volume is the upstream served volume for all lanes.

VISSIM Post-Processor
Average Results from 10 Runs
Freeway Operations Summary

SR 65 Widening
Construction Year - GP Alternative
PM Peak Hour

Location	Facility Type	Mainline Volume (vph)			On-ramp Volume (vph)			Off-ramp Volume (vph)			Speed (mph)		Density (vplpm)		LOS
		Avg.	St. Dev.	%	Avg.	St. Dev.	%	Avg.	St. Dev.	%	Avg.	St. Dev.	Avg.	St. Dev.	
1 I-80 EB - Auburn Blvd On-ramp	Merge	7,687	36	101.9%	929	21	96.8%				62.0	0.8	27.0	0.6	C
2 I-80 EB - Auburn Blvd to Douglas Blvd	Basic	8,606	69	101.2%							59.4	1.1	33.6	0.7	D
3 I-80 EB - Douglas Blvd Slip Off	Diverge	8,594	93	101.1%				1,222	62	105.4%	54.3	10.6	35.7	11.0	E
4 I-80 EB - Douglas Blvd WB Off-ramp	Diverge	7,336	140	99.9%				761	56	110.3%	45.5	18.8	57.4	42.7	F
5 I-80 EB - Douglas Blvd Off to On-ramp	Basic	6,501	174	97.8%							31.5	13.3	80.4	40.2	F
6 I-80 EB - Douglas Blvd On-ramp	Merge	6,460	195	97.1%	961	260	72.8%				19.1	5.1	131.3	8.8	F
7 I-80 EB - Eureka Rd Off-ramp	Diverge	7,343	238	92.1%				1,044	88	94.9%	23.0	4.5	109.7	7.7	F
8 I-80 EB - Eureka Rd Off to On-ramp	Basic	6,270	242	78.7%							23.3	8.7	102.8	26.3	F
9 I-80 EB - Eureka Rd EB On-ramp	Merge	6,265	240	78.6%	327	22	102.0%				18.1	1.3	120.1	9.9	F
10 I-80 EB - Eureka Rd to Taylor Rd	Weave	6,599	208	79.6%	1,145	56	102.3%	521	54	91.4%	20.6	7.0	115.9	19.4	F
11 I-80 EB - Taylor Rd to SR 65	Basic	7,208	183	81.5%							19.5	1.6	109.5	4.8	F
17 I-80 EB - SR 65 Off-ramp	Diverge	7,206	202	81.5%				3,894	53	92.9%	24.4	2.0	95.0	1.9	F
18 I-80 EB - SR 65 Off to On-ramp	Basic	3,303	193	71.0%							62.9	0.4	18.2	1.1	C
19 I-80 EB - SR-65 On-ramp	Merge	3,305	188	71.1%	1,919	80	98.9%				62.3	0.9	23.2	1.1	C
21 I-80 EB - SR-65 to Rocklin Rd	Basic	5,225	206	79.3%							63.0	0.2	23.2	1.0	C
22 I-80 EB - Rocklin Rd Off-ramp	Diverge	5,223	195	79.3%				1,643	97	96.1%	61.4	6.0	24.8	6.4	C
23 I-80 EB - Rocklin Rd Off to On-ramp	Basic	3,576	149	73.3%							63.0	1.2	21.0	1.1	C
24 I-80 EB - Rocklin Rd On-ramp	Merge	3,577	146	73.3%	275	26	105.6%				60.4	1.0	21.0	1.1	C
25 I-80 EB - Rocklin Rd to Sierra College Blvd	Basic	3,849	145	74.9%							63.1	0.2	22.0	0.9	C
26 I-80 EB - Sierra College Blvd Off-ramp	Diverge	3,849	145	74.9%				291	26	91.0%	62.6	0.2	23.2	0.8	C
27 I-80 EB - Sierra College Blvd Off to On-ramp	Basic	3,555	139	73.8%							63.2	0.1	20.8	0.9	C
28 I-80 EB - Sierra College Blvd SB On-ramp	Merge	3,554	144	73.7%	236	3	94.6%				61.3	0.6	19.9	0.9	B
29 I-80 EB - Sierra College Blvd NB On-ramp	Merge	3,792	147	74.8%	609	13	101.4%				60.9	0.7	23.2	1.0	C
38 I-80 WB - Sierra College Blvd Off-ramp	Diverge	3,657	16	105.7%				581	46	105.6%	60.9	0.4	19.3	0.2	B
39 I-80 WB - Sierra College Blvd Off to On-ramp	Basic	3,073	54	105.6%							63.7	0.2	18.0	0.3	B
40 I-80 WB - Sierra College Blvd NB On-ramp	Merge	3,072	57	105.6%	170	4	99.7%				63.2	0.3	16.8	0.3	B
41 I-80 WB - Sierra College Blvd SB On-ramp	Merge	3,243	58	105.3%	229	5	91.5%				62.9	0.3	17.7	0.4	B
42 I-80 WB - Sierra College Blvd to Rocklin Rd	Basic	3,467	65	104.1%							63.3	0.2	19.8	0.5	C
43 I-80 WB - Rocklin Rd Off-ramp	Diverge	3,465	63	104.1%				284	40	105.2%	62.9	0.2	20.6	0.4	C
44 I-80 WB - Rocklin Rd Off to On-ramp	Basic	3,177	65	103.8%							63.6	0.1	18.5	0.4	C
45 I-80 WB - Rocklin Rd On-ramp	Merge	3,177	64	103.8%	1,268	62	90.6%				60.3	0.5	22.4	0.8	C
46 I-80 WB - Rocklin Rd to HOV Lane Start	Basic	4,440	104	99.5%							62.8	0.3	24.0	0.8	C
47 I-80 WB - HOV Lane Start to SR-65	Basic	4,437	100	99.5%							62.6	0.4	19.8	0.4	C
48 I-80 WB - SR-65 Off-ramp	Diverge	4,437	99	99.5%				1,786	72	100.9%	63.9	0.1	18.2	0.4	B
49 I-80 WB - SR-65 Off to On-ramp	Basic	2,652	87	98.6%							63.9	0.1	15.0	0.6	B
50 I-80 WB - SR-65 On-ramp	Merge	2,651	86	98.5%	3,291	105	100.3%				61.8	0.3	23.4	0.7	C
60 I-80 WB - Taylor Rd On-ramp	Merge	5,939	118	99.5%	542	35	100.4%				61.0	0.3	28.3	1.2	D
61 I-80 WB - Atlantic St WB Off-ramp	Diverge	6,481	130	99.6%				383	42	91.1%	62.7	0.5	28.0	0.9	C
62 I-80 WB - Atlantic St EB Off-ramp	Diverge	6,101	121	100.2%				985	66	100.5%	62.5	0.3	28.9	1.0	D
63 I-80 WB - Atlantic St EB Off to On-ramp	Basic	5,115	112	100.1%							63.5	0.1	20.6	0.3	C
64 I-80 WB - Atlantic St On-ramp	Merge	5,114	113	100.1%	1,380	76	101.5%				60.4	1.4	29.8	0.9	D
65 I-80 WB - Douglas Blvd Off-ramp	Diverge	6,491	141	100.3%				943	64	98.2%	62.1	0.3	27.6	0.7	C
66 I-80 WB - Douglas Blvd Off to On-ramp	Basic	5,550	142	100.7%							63.5	0.1	22.8	0.5	C
67 I-80 WB - Douglas Blvd WB On-ramp	Merge	5,549	146	100.7%	1,363	146	96.7%				57.8	1.1	26.7	0.7	C
68 I-80 WB - Douglas Blvd Slip On	Merge	6,911	215	99.9%	694	40	84.6%				61.3	0.8	30.2	0.5	D
69 I-80 WB - Douglas Blvd to Riverside Ave	Basic	7,606	207	98.3%							62.2	0.2	29.9	0.6	D
70 I-80 WB - Riverside Ave Off-ramp	Diverge	7,606	209	98.3%				1,173	69	101.1%	62.8	0.1	31.2	0.7	D
71 I-80 WB - Riverside Ave Off to On-ramp	Basic	6,433	195	97.8%							63.3	0.1	24.6	0.5	C
72 I-80 WB - Riverside Ave NB On-ramp	Merge	6,434	189	97.8%	206	1	98.1%				63.4	0.1	22.6	0.7	C
73 I-80 WB - Riverside Ave SB On-ramp	Merge	6,644	185	97.8%	532	9	98.5%				61.8	0.7	26.8	0.8	C
74 I-80 WB - Riverside Ave to Antelope Rd	Basic	7,178	184	97.9%							62.3	0.2	27.6	0.8	D
75 I-80 WB - Antelope Rd Off-ramp	Diverge	7,177	176	97.9%				929	62	97.8%	62.3	0.5	28.9	1.1	D
76 I-80 WB - Antelope Rd Off to On-ramp	Basic	6,238	157	97.8%							63.0	0.3	23.9	0.6	C
77 I-80 WB - Antelope Rd WB On-ramp	Merge	6,242	157	97.8%	372	8	98.0%				60.8	0.8	22.8	0.8	C
78 I-80 WB - Antelope Rd to Truck Scales	Weave	6,614	157	97.8%	368	14	99.4%	64	14	58.5%	62.5	0.4	25.0	0.5	C
79 I-80 WB - Truck Scales Off to On-ramp	Basic	6,923	152	98.6%							63.0	0.1	26.0	0.4	C
80 I-80 WB - Truck Scales On-ramp	Merge	6,924	159	98.6%	65	14	58.7%				62.8	0.1	26.3	0.4	C
81 I-80 WB - Truck Scales to Elkhorn Blvd	Basic	6,986	151	98.0%							61.9	0.4	27.4	0.4	D
82 I-80 WB - Elkhorn Blvd Off-ramp	Diverge	6,985	156	98.0%				1,041	56	94.6%	62.6	0.2	25.4	0.5	C
83 I-80 WB - Elkhorn Blvd Off to On-ramp	Basic	5,950	150	98.7%							63.1	0.3	23.0	0.4	C
84 I-80 WB - Elkhorn Blvd WB On-ramp	Merge	5,951	154	98.7%	899	2	99.9%				58.2	0.9	24.7	0.8	C
85 I-80 WB - Elkhorn Blvd EB On-ramp	Merge	6,852	157	98.9%	657	18	102.6%				62.0	0.9	28.2	0.7	D

Notes: Average density reported for the analysis area only: for example, within the ramp influence area and not including the HOV lane.
Mainline volume is the upstream served volume for all lanes.

VISSIM Post-Processor
Average Results from 10 Runs
Freeway Operations Summary

SR 65 Widening
Construction Year - GP Alternative
PM Peak Hour

Location	Facility Type	Mainline Volume (vph)			On-ramp Volume (vph)			Off-ramp Volume (vph)			Speed (mph)		Density (vplpm)		LOS	
		Avg.	St. Dev.	%	Avg.	St. Dev.	%	Avg.	St. Dev.	%	Avg.	St. Dev.	Avg.	St. Dev.		
100 SR-65 NB - EB I-80 Connector	Basic	3,895	50	93.0%							35.1	4.3	63.2	6.2	F	
101 SR-65 NB - WB I-80 Connector	Basic	1,785	71	100.8%							46.6	9.1	31.3	7.7	D	
103 SR-65 NB - I-80 WB On-ramp	Merge	3,895	56	92.9%	1,780	77	100.6%				56.5	11.4	36.3	12.2	E	
104 SR-65 NB - I-80 to Stanford Ranch Rd	Basic	5,673	115	95.2%							58.5	13.2	35.7	15.8	E	
105 SR-65 NB - Stanford Ranch Rd Off-ramp	Diverge	5,673	116	95.2%				1,044	52	90.8%	57.3	14.1	35.7	19.9	E	
106 SR-65 NB - Stanford Ranch Rd Off to On-ramp	Basic	4,622	124	96.1%							62.7	0.4	25.2	0.6	C	
107 SR-65 NB - Stanford Ranch Rd to Pleasant Grove Blvd	Weave	4,618	129	96.0%	1,365	52	100.4%	1,022	50	100.2%	62.0	0.3	26.0	0.4	C	
110 SR-65 NB - Pleasant Grove Blvd Off to On-ramp	Basic	4,958	140	96.3%							60.4	5.9	28.3	5.5	D	
111 SR-65 NB - Pleasant Grove Blvd On-ramp	Merge	4,959	144	96.3%	708	50	99.7%				50.7	10.3	39.7	10.9	E	
112 SR-65 NB - Blue Oaks Blvd Off-ramp	Diverge	5,655	164	96.5%				1,974	120	95.3%	60.2	0.8	32.5	0.5	D	
114 SR-65 NB - Blue Oaks Blvd Off to On-ramp	Basic	3,687	121	97.3%							62.4	0.3	30.2	0.5	D	
115 SR-65 NB - Blue Oaks Blvd On-ramp	Merge	3,686	124	97.3%	756	49	103.6%				61.7	0.2	26.5	0.5	C	
116 SR-65 NB - Blue Oaks Blvd to Sunset Blvd	Basic	4,439	124	98.2%							62.4	0.2	26.8	0.6	D	
118 SR-65 NB - Sunset Blvd Off-ramp	Diverge	4,441	123	98.3%					972	58	99.2%	62.7	0.1	27.7	0.7	C
119 SR-65 NB - Sunset Blvd Off to On-ramp	Basic	3,466	107	97.9%							62.5	0.2	28.2	1.4	D	
120 SR-65 NB - Sunset Blvd EB On-ramp	Merge	3,465	107	97.9%	76	17	108.7%				62.1	0.8	28.6	1.4	D	
121 SR-65 NB - Sunset Blvd to Whitney Ranch Pkwy	Weave	3,536	113	97.9%	199	16	104.7%	550	50	94.8%	62.1	0.3	26.7	1.2	C	
124 SR-65 NB - Whitney Ranch Pkwy Off to On-ramp	Basic	3,181	102	98.8%							62.5	0.2	26.4	1.2	D	
125 SR-65 NB - Whitney Ranch Pkwy EB On-ramp	Merge	3,183	104	98.8%	263	14	94.1%				61.7	0.7	27.5	1.3	C	
126 SR-65 NB - Whitney Ranch Pkwy to Twelve Bridges Dr	Weave	3,446	108	98.4%	271	12	100.3%	827	54	102.0%	62.6	0.1	23.1	0.9	C	
129 SR-65 NB - Twelve Bridges Dr Off to On-ramp	Basic	2,885	78	97.5%							62.8	0.1	24.4	0.8	C	
130 SR-65 NB - Twelve Bridges Dr to Lincoln Blvd	Weave	2,886	73	97.5%	274	26	91.4%	1,079	56	96.3%	63.2	0.1	20.3	0.6	C	
133 SR-65 NB - Lincoln Blvd to Ferrari Ranch Rd	Basic	2,078	66	97.1%							63.5	0.1	19.1	0.7	C	
134 SR-65 NB - Ferrari Ranch Rd Off-ramp	Diverge	2,079	65	97.1%				1,397	66	96.4%	64.1	0.1	14.7	0.5	B	
135 SR-65 NB - Ferrari Ranch Rd Off to On-ramp	Basic	680	59	98.5%							64.6	0.3	5.5	0.6	A	
136 SR-65 NB - Ferrari Ranch Rd On-ramp	Merge	678	61	98.3%	83	6	91.7%				63.2	0.2	5.7	0.4	A	
150 SR-65 SB - Ferrari Ranch Rd Off-ramp	Diverge	992	33	103.3%				144	15	96.0%	64.4	0.3	8.4	0.2	A	
151 SR-65 SB - Ferrari Ranch Rd Off to On-ramp	Basic	848	39	104.7%							64.5	0.2	7.1	0.2	A	
152 SR-65 SB - Ferrari Ranch Rd WB On-ramp	Merge	848	40	104.7%	476	18	99.1%				61.8	0.2	8.0	0.2	A	
153 SR-65 SB - Ferrari Ranch Rd EB On-ramp	Merge	1,324	51	102.7%	319	16	91.1%				62.5	0.2	10.7	0.3	B	
154 SR-65 SB - Ferrari Ranch Rd to Lane Drop	Basic	1,642	53	100.1%							64.1	0.3	13.9	0.4	B	
155 SR-65 SB - Lane Drop to Lincoln Blvd	Basic	1,642	54	100.1%							64.1	0.2	13.8	0.4	B	
156 SR-65 SB - Lincoln Blvd to Twelve Bridges Dr	Weave	1,643	54	100.2%	722	40	98.9%	259	32	96.0%	62.5	0.4	14.6	0.3	B	
159 SR-65 SB - Twelve Bridges Dr Off to On-ramp	Basic	2,104	64	100.2%							63.5	0.3	17.3	0.4	B	
160 SR-65 SB - Twelve Bridges Dr to Placer Pkwy	Weave	2,105	66	100.2%	470	20	96.0%	463	45	98.5%	63.1	0.2	16.0	0.5	B	
163 SR-65 SB - Placer Pkwy Off to On-ramp	Basic	2,112	65	99.6%							63.1	0.4	17.5	0.7	B	
164 SR-65 SB - Placer Pkwy WB On-ramp	Merge	2,112	70	99.6%	258	24	99.2%				62.9	0.4	18.5	0.7	B	
165 SR-65 SB - Placer Pkwy to Sunset Blvd	Weave	2,368	81	99.5%	369	23	97.1%	260	30	96.3%	62.8	0.2	19.3	0.9	B	
168 SR-65 SB - Sunset Blvd Off to On-ramp	Basic	2,477	80	99.5%							63.1	0.1	20.1	0.6	C	
169 SR-65 SB - Sunset Blvd WB On-ramp	Merge	2,478	82	99.5%	795	34	106.0%				59.6	1.2	24.6	0.9	C	
170 SR-65 SB - Sunset Blvd to Blue Oaks Blvd	Weave	3,276	85	101.1%	745	25	100.7%	735	48	95.5%	62.2	0.2	24.7	0.7	C	
172 SR-65 SB - Blue Oaks Blvd Off to Lane Add	Basic	3,284	82	102.3%							62.4	0.1	27.3	0.6	D	
173 SR-65 SB - Lane Add to Blue Oaks Blvd WB On-ramp	Basic	3,284	84	102.3%							62.8	0.2	23.8	0.6	C	
174 SR-65 SB - Blue Oaks Blvd WB On-ramp	Merge	3,285	84	102.3%	474	26	100.9%				61.4	0.3	23.4	0.5	C	
175 SR-65 SB - Blue Oaks Blvd WB On to EB On-ramp	Basic	3,760	89	102.2%							63.9	0.1	21.0	0.5	C	
176 SR-65 SB - Blue Oaks Blvd EB On-ramp	Merge	3,760	88	102.2%	1,239	58	102.4%				61.9	0.3	23.3	0.4	C	
177 SR-65 SB - Pleasant Grove Blvd Off-ramp	Diverge	5,003	106	102.3%				559	48	96.3%	63.0	0.8	23.2	0.6	C	
178 SR-65 SB - Pleasant Grove Blvd Off to On-ramp	Basic	4,445	109	103.1%							63.9	0.2	18.6	0.3	C	
179 SR-65 SB - Pleasant Grove Blvd WB On-ramp	Merge	4,442	111	103.1%	287	10	95.7%				62.5	0.2	24.6	0.6	C	
180 SR-65 SB - Pleasant Grove Blvd EB On-ramp	Merge	4,723	110	102.5%	734	25	96.6%				61.6	0.6	22.8	0.5	C	
181 SR-65 SB - Pleasant Grove Blvd to Galleria Blvd	Basic	5,454	104	101.6%							63.0	0.4	23.8	0.5	C	
182 SR-65 SB - Galleria Blvd Off-ramp	Diverge	5,454	103	101.6%				1,177	59	103.2%	63.3	0.2	23.9	0.5	C	
183 SR-65 SB - Galleria Blvd Off to On-ramp	Basic	4,270	97	101.0%							62.2	0.4	26.1	0.4	D	
185 SR-65 SB - Galleria Blvd On-ramp	Merge	4,267	96	100.9%	941	50	95.0%				57.6	2.9	33.3	1.3	D	
186 SR-65 SB - I-80 Off-ramp	Diverge	5,209	115	99.8%				3,291	113	100.3%	60.9	0.7	29.0	0.6	D	
187 SR-65 SB - EB I-80 Connector (2 lanes)	Basic	1,924	89	99.1%							54.0	6.9	37.3	6.1	E	
188 SR-65 SB - EB I-80 Connector (1 lane)	Basic	1,922	84	99.1%							59.2	2.1	34.3	2.0	D	
189 SR-65 SB - WB I-80 Connector	Basic	3,294	107	100.4%							52.6	0.2	32.1	0.9	D	

Notes: Average density reported for the analysis area only: for example, within the ramp influence area and not including the HOV lane.
Mainline volume is the upstream served volume for all lanes.

VISSIM Post-Processor
Average Results from 10 Runs
Intersection Volume and Delay

SR 65 Widening
Construction Year - GP Alternative
AM Peak Hour

	Intersection	Control	Volume (vph)		Percent Served	Delay (sec/veh)		Level of Service
			Demand	Served		Average	Std. Dev.	
1	Lincoln Blvd/Sterling Parkway	Signal	1,850	2,052	110.9%	10.7	0.4	B
2	SR-65 SB Ramps/Twelve Bridges Dr	Signal	1,285	1,436	111.8%	10.1	0.5	B
3	SR-65 NB Ramps/Twelve Bridges Dr	Signal	1,385	1,485	107.2%	9.0	1.2	A
4	SR-65 SB Ramps/Sunset Blvd	Signal	2,650	2,856	107.8%	12.0	2.5	B
5	SR-65 NB Ramps/Sunset Blvd	Signal	2,790	3,021	108.3%	13.3	0.4	B
6	SR-65 SB Ramps-Washington Blvd/Blue Oaks Blvd	Signal	4,530	4,721	104.2%	35.0	3.9	C
7	SR-65 NB Ramps/Blue Oaks Blvd	Signal	3,080	3,294	106.9%	14.9	3.2	B
8	SR-65 SB Ramps/Pleasant Grove Blvd	Signal	3,605	3,725	103.3%	6.8	0.5	A
9	SR-65 NB Ramps/Pleasant Grove Blvd	Signal	2,725	2,792	102.5%	13.8	0.8	B
10	Stanford Ranch Rd/Five Star Blvd	Signal	2,780	2,891	104.0%	26.7	1.5	C
11	SR-65 NB Ramps/Stanford Ranch Rd	Signal	3,440	3,622	105.3%	19.8	9.5	B
12	SR-65 SB Ramps/Galleria Blvd	Signal	3,785	3,986	105.3%	17.4	4.9	B
13	Galleria Blvd/Antelope Creek Dr	Signal	2,941	3,106	105.6%	13.2	1.4	B
14	Galleria Blvd/Roseville Pkwy	Signal	5,136	5,525	107.6%	41.8	9.0	D
15	Creekside Ridge Dr/Roseville Pkwy	Signal	3,515	3,709	105.5%	8.3	2.6	A
16	Taylor Rd/East Roseville Pkwy	Signal	4,500	4,729	105.1%	45.6	8.8	D
17	North Sunrise Ave/East Roseville Pkwy	Signal	4,285	4,570	106.6%	27.7	3.2	C
18	Wills Rd/Atlantic St	Signal	1,985	2,182	109.9%	24.1	3.8	C
19	I-80 WB Ramps/Atlantic St	Signal	3,400	3,638	107.0%	14.1	1.6	B
20	Taylor Rd-I-80 EB Ramps/Eureka Rd	Signal	4,345	4,546	104.6%	25.3	4.6	C
21	North Sunrise Ave/Eureka Rd	Signal	3,950	4,152	105.1%	32.9	3.0	C
22	Harding Blvd/Wills Rd	Signal	355	362	102.1%	24.5	3.3	C
23	Harding Blvd/Douglas Blvd	Signal	2,685	2,924	108.9%	29.8	22.9	C
24	I-80 WB Ramps/Douglas Blvd	Signal	3,675	3,957	107.7%	23.6	7.2	C

Network Summary	
Total Demand Volume (veh/hr)	74,677
Total Volume Served (veh/hr)	79,280
Percent Served	106.2%

- Notes: 1. Volume is measured for the entire peak hour.
2. Delay is measured for the peak 15 minutes in the peak hour.

VISSIM Post-Processor
Average Results from 10 Runs
Intersection Volume and Delay

SR 65 Widening
Construction Year - GP Alternative
AM Peak Hour

	Intersection	Control	Volume (vph)		Percent Served	Delay (sec/veh)		Level of Service
			Demand	Served		Average	Std. Dev.	
25	I-80 EB Ramps/Douglas Blvd	Signal	4,060	4,410	108.6%	9.7	3.5	A
26	North Sunrise Ave/Douglas Blvd	Signal	4,400	4,711	107.1%	33.3	2.1	C
27	Pacific St/Woodside Dr	Signal	1,705	1,868	109.6%	6.9	0.8	A
28	Pacific St/Sunset Blvd	Signal	2,465	2,718	110.3%	24.1	1.6	C
29	Granite Dr/Rocklin Rd	Signal	2,301	2,375	103.2%	17.7	1.4	B
30	I-80 WB Ramps/Rocklin Rd	Signal	2,550	2,651	103.9%	28.6	3.4	C
31	I-80 EB Ramps/Rocklin Rd	Signal	2,690	2,873	106.8%	49.1	12.6	D
32	Aguilar Rd/Rocklin Rd	Signal	1,940	2,099	108.2%	20.3	16.2	C
33	Lincoln Blvd/SR-65 NB Off-Ramp	Signal	1,795	1,982	110.4%	6.3	0.8	A
34	Lincoln Blvd/SR-65 SB On-Ramp	Signal	1,245	1,358	109.1%	21.9	0.9	C
35	SR-65 SB Ramps/Placer Pkwy	Signal	1,715	1,764	102.9%	8.4	0.6	A
36	SR-65 NB Ramps/Whitney Ranch Pkwy	Signal	1,625	1,736	106.8%	8.5	0.4	A
40	Galleria Blvd/Berry St	Signal	1,930	2,092	108.4%	10.8	1.9	B

Network Summary	
Total Demand Volume (veh/hr)	30,421
Total Volume Served (veh/hr)	32,636
Percent Served	107.3%

- Notes: 1. Volume is measured for the entire peak hour.
2. Delay is measured for the peak 15 minutes in the peak hour.

VISSIM Post-Processor
Average Results from 10 Runs
Intersection Volume and Delay

SR 65 Widening
Construction Year - GP Alternative
PM Peak Hour

	Intersection	Control	Volume (vph)		Percent Served	Delay (sec/veh)		Level of Service
			Demand	Served		Average	Std. Dev.	
1	Lincoln Blvd/Sterling Parkway	Signal	2,330	2,279	97.8%	9.5	0.5	A
2	SR-65 SB Ramps/Twelve Bridges Dr	Signal	1,100	1,067	97.0%	11.9	3.9	B
3	SR-65 NB Ramps/Twelve Bridges Dr	Signal	1,590	1,574	99.0%	11.4	1.0	B
4	SR-65 SB Ramps/Sunset Blvd	Signal	2,885	3,022	104.8%	6.2	0.3	A
5	SR-65 NB Ramps/Sunset Blvd	Signal	2,810	2,918	103.9%	13.6	0.9	B
6	SR-65 SB Ramps-Washington Blvd/Blue Oaks Blvd	Signal	5,450	5,643	103.5%	44.4	7.0	D
7	SR-65 NB Ramps/Blue Oaks Blvd	Signal	4,030	4,144	102.8%	18.3	2.3	B
8	SR-65 SB Ramps/Pleasant Grove Blvd	Signal	5,200	5,184	99.7%	29.3	15.6	C
9	SR-65 NB Ramps/Pleasant Grove Blvd	Signal	4,390	4,388	99.9%	32.5	34.8	C
10	Stanford Ranch Rd/Five Star Blvd	Signal	4,355	4,050	93.0%	75.9	16.7	E
11	SR-65 NB Ramps/Stanford Ranch Rd	Signal	5,615	5,675	101.1%	24.6	29.7	C
12	SR-65 SB Ramps/Galleria Blvd	Signal	5,665	5,794	102.3%	16.6	2.3	B
13	Galleria Blvd/Antelope Creek Dr	Signal	4,720	4,690	99.4%	24.5	3.1	C
14	Galleria Blvd/Roseville Pkwy	Signal	7,610	7,624	100.2%	61.5	8.1	E
15	Creekside Ridge Dr/Roseville Pkwy	Signal	4,700	4,771	101.5%	31.7	5.8	C
16	Taylor Rd/East Roseville Pkwy	Signal	5,890	5,941	100.9%	52.9	9.4	D
17	North Sunrise Ave/East Roseville Pkwy	Signal	5,420	5,536	102.1%	41.2	7.5	D
18	Wills Rd/Atlantic St	Signal	2,965	3,019	101.8%	35.8	4.7	D
19	I-80 WB Ramps/Atlantic St	Signal	4,500	4,573	101.6%	12.2	1.4	B
20	Taylor Rd-I-80 EB Ramps/Eureka Rd	Signal	5,730	5,908	103.1%	72.2	11.2	E
21	North Sunrise Ave/Eureka Rd	Signal	5,565	5,777	103.8%	44.1	3.7	D
22	Harding Blvd/Wills Rd	Signal	370	401	108.4%	26.1	3.5	C
23	Harding Blvd/Douglas Blvd	Signal	3,710	3,595	96.9%	128.2	20.6	F
24	I-80 WB Ramps/Douglas Blvd	Signal	4,505	4,512	100.2%	31.2	7.9	C

Network Summary	
Total Demand Volume (veh/hr)	101,105
Total Volume Served (veh/hr)	102,083
Percent Served	101.0%

- Notes: 1. Volume is measured for the entire peak hour.
2. Delay is measured for the peak 15 minutes in the peak hour.

**VISSIM Post-Processor
Average Results from 10 Runs
Intersection Volume and Delay**

**SR 65 Widening
Construction Year - GP Alternative
PM Peak Hour**

	Intersection	Control	Volume (vph)		Percent Served	Delay (sec/veh)		Level of Service
			Demand	Served		Average	Std. Dev.	
25	I-80 EB Ramps/Douglas Blvd	Signal	5,210	5,221	100.2%	35.1	19.3	D
26	North Sunrise Ave/Douglas Blvd	Signal	5,850	5,741	98.1%	85.6	59.1	F
27	Pacific St/Woodside Dr	Signal	2,235	2,214	99.1%	7.0	1.0	A
28	Pacific St/Sunset Blvd	Signal	3,455	3,432	99.3%	29.1	2.6	C
29	Granite Dr/Rocklin Rd	Signal	3,690	3,479	94.3%	129.7	4.3	F
30	I-80 WB Ramps/Rocklin Rd	Signal	3,785	3,685	97.4%	25.1	6.0	C
31	I-80 EB Ramps/Rocklin Rd	Signal	3,535	3,555	100.6%	45.7	33.2	D
32	Aguilar Rd/Rocklin Rd	Signal	2,395	2,435	101.7%	22.7	3.0	C
33	Lincoln Blvd/SR-65 NB Off-Ramp	Signal	2,185	2,139	97.9%	9.1	0.9	A
34	Lincoln Blvd/SR-65 SB On-Ramp	Signal	1,135	1,129	99.4%	21.6	2.7	C
35	SR-65 SB Ramps/Placer Pkwy	Signal	2,010	2,004	99.7%	8.9	0.8	A
36	SR-65 NB Ramps/Whitney Ranch Pkwy	Signal	2,035	2,030	99.8%	26.6	19.2	C
40	Galleria Blvd/Berry St	Signal	2,875	2,943	102.4%	10.0	1.3	A

Network Summary	
Total Demand Volume (veh/hr)	40,395
Total Volume Served (veh/hr)	40,007
Percent Served	99.0%

- Notes: 1. Volume is measured for the entire peak hour.
2. Delay is measured for the peak 15 minutes in the peak hour.

Intersection 2

SR-65 SB Ramps/Twelve Bridges Dr

Signalized

Direction	Movement	Storage (ft)	Average Queue (ft)		Maximum Queue (ft)		Exceeds Storage?
			Average	Std. Dev.	Average	Std. Dev.	
SB	Left Turn	440	19	5	105	16	NO
	Through						
	Right Turn	1,500	13	6	100	16	NO

Intersection 3

SR-65 NB Ramps/Twelve Bridges Dr

Signalized

Direction	Movement	Storage (ft)	Average Queue (ft)		Maximum Queue (ft)		Exceeds Storage?
			Average	Std. Dev.	Average	Std. Dev.	
NB	Left Turn	700	6	1	51	11	NO
	Through						
	Right Turn	1,500	6	1	51	11	NO

Intersection 4

SR-65 SB Ramps/Sunset Blvd

Signalized

Direction	Movement	Storage (ft)	Average Queue (ft)		Maximum Queue (ft)		Exceeds Storage?
			Average	Std. Dev.	Average	Std. Dev.	
SB	Left Turn	360	45	7	189	31	NO
	Through						
	Right Turn	1,330	47	7	191	31	NO

Intersection 5

SR-65 NB Ramps/Sunset Blvd

Signalized

Direction	Movement	Storage (ft)	Average Queue (ft)		Maximum Queue (ft)		Exceeds Storage?
			Average	Std. Dev.	Average	Std. Dev.	
NB	Left Turn	1,400	62	6	265	34	NO
	Through						
	Right Turn	1,400	9	2	85	18	NO

Note: The "Average Queue" is calculated on a time-step basis so that queues when the approach is green (zero length) are included in the average.

Intersection 6

SR-65 SB Ramps-Washington Blvd/Blue Oaks Blvd

Signalized

Direction	Movement	Storage (ft)	Average Queue (ft)		Maximum Queue (ft)		Exceeds Storage?
			Average	Std. Dev.	Average	Std. Dev.	
SB	Left Turn	200	21	3	116	37	NO
	Through	2,260	71	9	328	75	NO
	Right Turn	200	0	1	57	64	NO

Intersection 7

SR-65 NB Ramps/Blue Oaks Blvd

Signalized

Direction	Movement	Storage (ft)	Average Queue (ft)		Maximum Queue (ft)		Exceeds Storage?
			Average	Std. Dev.	Average	Std. Dev.	
NB	Left Turn	400	59	42	645	420	MAX
	Through						
	Right Turn	1,100	60	42	646	420	NO

Intersection 8

SR-65 SB Ramps/Pleasant Grove Blvd

Signalized

Direction	Movement	Storage (ft)	Average Queue (ft)		Maximum Queue (ft)		Exceeds Storage?
			Average	Std. Dev.	Average	Std. Dev.	
SB	Left Turn	430	25	4	132	23	NO
	Through						
	Right Turn	1,130	27	4	134	23	NO

Intersection 9

SR-65 NB Ramps/Pleasant Grove Blvd

Signalized

Direction	Movement	Storage (ft)	Average Queue (ft)		Maximum Queue (ft)		Exceeds Storage?
			Average	Std. Dev.	Average	Std. Dev.	
NB	Left Turn	1,420	36	1	129	18	NO
	Through						
	Right Turn	1,420	34	2	129	18	NO

Note: The "Average Queue" is calculated on a time-step basis so that queues when the approach is green (zero length) are included in the average.

Intersection 11

SR-65 NB Ramps/Stanford Ranch Rd

Signalized

Direction	Movement	Storage (ft)	Average Queue (ft)		Maximum Queue (ft)		Exceeds Storage?
			Average	Std. Dev.	Average	Std. Dev.	
EB	Left Turn						
	Through						
	Right Turn	1,800	0	0	13	13	NO
WB	Left Turn						
	Through						
	Right Turn	1,170	9	2	100	24	NO

Intersection 12

SR-65 SB Ramps/Galleria Blvd

Signalized

Direction	Movement	Storage (ft)	Average Queue (ft)		Maximum Queue (ft)		Exceeds Storage?
			Average	Std. Dev.	Average	Std. Dev.	
EB	Left Turn						
	Through						
	Right Turn	1,130	50	2	270	41	NO
WB	Left Turn						
	Through						
	Right Turn	1,780	0	0	46	25	NO

Intersection 19

I-80 WB Ramps/Atlantic St

Signalized

Direction	Movement	Storage (ft)	Average Queue (ft)		Maximum Queue (ft)		Exceeds Storage?
			Average	Std. Dev.	Average	Std. Dev.	
NB	Left Turn						
	Through						
	Right Turn	1,150	0	0	0	0	NO
SB	Left Turn						
	Through						
	Right Turn	1,430	0	0	4	14	NO

Note: The "Average Queue" is calculated on a time-step basis so that queues when the approach is green (zero length) are included in the average.

Intersection 20

Taylor Rd-I-80 EB Ramps/Eureka Rd

Signalized

Direction	Movement	Storage (ft)	Average Queue (ft)		Maximum Queue (ft)		Exceeds Storage?
			Average	Std. Dev.	Average	Std. Dev.	
NB	Left Turn	180	74	25	391	448	MAX
	Through	1,700	55	7	226	34	NO
	Right Turn	1,700	4	6	140	429	NO
SB	Left Turn	550	16	6	79	14	NO
	Through						
	Right Turn	550	61	8	284	51	NO
EB	Left Turn	1,120	31	4	117	13	NO
	Through	1,120	79	19	590	124	NO
	Right Turn	810	8	8	177	119	NO
WB	Left Turn						
	Through	1,370	34	8	293	42	NO
	Right Turn	280	0	0	2	7	NO

Intersection 24

I-80 WB Ramps/Douglas Blvd

Signalized

Direction	Movement	Storage (ft)	Average Queue (ft)		Maximum Queue (ft)		Exceeds Storage?
			Average	Std. Dev.	Average	Std. Dev.	
SB	Left Turn	1,530	65	65	328	78	NO
	Through	1,530	65	65	328	78	NO
	Right Turn	730	65	65	328	78	NO

Note: The "Average Queue" is calculated on a time-step basis so that queues when the approach is green (zero length) are included in the average.

VISSIM Post-Processor
 Average Results from 10 Runs
 Queue Length

SR 65 Widening
 Construction Year - GP Alternative
 AM Peak Hour

Intersection 25

I-80 EB Ramps/Douglas Blvd

Signalized

Direction	Movement	Storage (ft)	Average Queue (ft)		Maximum Queue (ft)		Exceeds Storage?
			Average	Std. Dev.	Average	Std. Dev.	
NB	Left Turn						
	Through						
	Right Turn	1,400	0	0	3	10	NO
SB	Left Turn						
	Through						
	Right Turn	1,250	16	3	120	37	NO

Intersection 30

I-80 WB Ramps/Rocklin Rd

Signalized

Direction	Movement	Storage (ft)	Average Queue (ft)		Maximum Queue (ft)		Exceeds Storage?
			Average	Std. Dev.	Average	Std. Dev.	
SB	Left Turn	700	10	3	99	29	NO
	Through						
	Right Turn	1,230	14	4	114	29	NO

Intersection 31

I-80 EB Ramps/Rocklin Rd

Signalized

Direction	Movement	Storage (ft)	Average Queue (ft)		Maximum Queue (ft)		Exceeds Storage?
			Average	Std. Dev.	Average	Std. Dev.	
NB	Left Turn	1,080	76	16	340	82	NO
	Through						
	Right Turn	1,080	74	16	337	82	NO

Note: The "Average Queue" is calculated on a time-step basis so that queues when the approach is green (zero length) are included in the average.

Intersection 33

Lincoln Blvd/SR-65 NB Off-Ramp

Signalized

Direction	Movement	Storage (ft)	Average Queue (ft)		Maximum Queue (ft)		Exceeds Storage?
			Average	Std. Dev.	Average	Std. Dev.	
WB	Left Turn	1,940	0	0	0	0	NO
	Through						
	Right Turn	1,940	0	0	5	15	NO

Intersection 35

SR-65 SB Ramps/Placer Pkwy

Signalized

Direction	Movement	Storage (ft)	Average Queue (ft)		Maximum Queue (ft)		Exceeds Storage?
			Average	Std. Dev.	Average	Std. Dev.	
SB	Left Turn	1,650	29	5	190	37	NO
	Through						
	Right Turn	1,650	29	5	190	37	NO

Intersection 36

SR-65 NB Ramps/Whitney Ranch Pkwy

Signalized

Direction	Movement	Storage (ft)	Average Queue (ft)		Maximum Queue (ft)		Exceeds Storage?
			Average	Std. Dev.	Average	Std. Dev.	
NB	Left Turn	1,620	23	4	149	28	NO
	Through						
	Right Turn	1,620	23	4	149	28	NO

Note: The "Average Queue" is calculated on a time-step basis so that queues when the approach is green (zero length) are included in the average.

Intersection 2

SR-65 SB Ramps/Twelve Bridges Dr

Signalized

Direction	Movement	Storage (ft)	Average Queue (ft)		Maximum Queue (ft)		Exceeds Storage?
			Average	Std. Dev.	Average	Std. Dev.	
SB	Left Turn	440	19	4	82	13	NO
	Through						
	Right Turn	1,500	12	4	78	13	NO

Intersection 3

SR-65 NB Ramps/Twelve Bridges Dr

Signalized

Direction	Movement	Storage (ft)	Average Queue (ft)		Maximum Queue (ft)		Exceeds Storage?
			Average	Std. Dev.	Average	Std. Dev.	
NB	Left Turn	700	18	1	93	20	NO
	Through						
	Right Turn	1,500	18	1	93	20	NO

Intersection 4

SR-65 SB Ramps/Sunset Blvd

Signalized

Direction	Movement	Storage (ft)	Average Queue (ft)		Maximum Queue (ft)		Exceeds Storage?
			Average	Std. Dev.	Average	Std. Dev.	
SB	Left Turn	360	30	3	127	19	NO
	Through						
	Right Turn	1,330	32	3	129	19	NO

Intersection 5

SR-65 NB Ramps/Sunset Blvd

Signalized

Direction	Movement	Storage (ft)	Average Queue (ft)		Maximum Queue (ft)		Exceeds Storage?
			Average	Std. Dev.	Average	Std. Dev.	
NB	Left Turn	1,400	49	8	202	31	NO
	Through						
	Right Turn	1,400	8	1	85	22	NO

Note: The "Average Queue" is calculated on a time-step basis so that queues when the approach is green (zero length) are included in the average.

Intersection 6

SR-65 SB Ramps-Washington Blvd/Blue Oaks Blvd

Signalized

Direction	Movement	Storage (ft)	Average Queue (ft)		Maximum Queue (ft)		Exceeds Storage?
			Average	Std. Dev.	Average	Std. Dev.	
SB	Left Turn	200	49	12	220	152	MAX
	Through	2,260	55	9	245	36	NO
	Right Turn	200	1	1	37	116	NO

Intersection 7

SR-65 NB Ramps/Blue Oaks Blvd

Signalized

Direction	Movement	Storage (ft)	Average Queue (ft)		Maximum Queue (ft)		Exceeds Storage?
			Average	Std. Dev.	Average	Std. Dev.	
NB	Left Turn	400	79	50	907	509	MAX
	Through						
	Right Turn	1,100	80	50	908	509	NO

Intersection 8

SR-65 SB Ramps/Pleasant Grove Blvd

Signalized

Direction	Movement	Storage (ft)	Average Queue (ft)		Maximum Queue (ft)		Exceeds Storage?
			Average	Std. Dev.	Average	Std. Dev.	
SB	Left Turn	430	24	3	115	19	NO
	Through						
	Right Turn	1,130	27	2	117	19	NO

Intersection 9

SR-65 NB Ramps/Pleasant Grove Blvd

Signalized

Direction	Movement	Storage (ft)	Average Queue (ft)		Maximum Queue (ft)		Exceeds Storage?
			Average	Std. Dev.	Average	Std. Dev.	
NB	Left Turn	1,420	57	13	229	130	NO
	Through						
	Right Turn	1,420	56	13	229	130	NO

Note: The "Average Queue" is calculated on a time-step basis so that queues when the approach is green (zero length) are included in the average.

Intersection 11

SR-65 NB Ramps/Stanford Ranch Rd

Signalized

Direction	Movement	Storage (ft)	Average Queue (ft)		Maximum Queue (ft)		Exceeds Storage?
			Average	Std. Dev.	Average	Std. Dev.	
EB	Left Turn						
	Through						
	Right Turn	1,800	0	0	31	35	NO
WB	Left Turn						
	Through						
	Right Turn	1,170	108	73	373	453	NO

Intersection 12

SR-65 SB Ramps/Galleria Blvd

Signalized

Direction	Movement	Storage (ft)	Average Queue (ft)		Maximum Queue (ft)		Exceeds Storage?
			Average	Std. Dev.	Average	Std. Dev.	
EB	Left Turn						
	Through						
	Right Turn	1,130	50	3	267	38	NO
WB	Left Turn						
	Through						
	Right Turn	1,780	8	3	165	49	NO

Intersection 19

I-80 WB Ramps/Atlantic St

Signalized

Direction	Movement	Storage (ft)	Average Queue (ft)		Maximum Queue (ft)		Exceeds Storage?
			Average	Std. Dev.	Average	Std. Dev.	
NB	Left Turn						
	Through						
	Right Turn	1,150	0	0	0	0	NO
SB	Left Turn						
	Through						
	Right Turn	1,430	0	0	21	28	NO

Note: The "Average Queue" is calculated on a time-step basis so that queues when the approach is green (zero length) are included in the average.

Intersection 20

Taylor Rd-I-80 EB Ramps/Eureka Rd

Signalized

Direction	Movement	Storage (ft)	Average Queue (ft)		Maximum Queue (ft)		Exceeds Storage?
			Average	Std. Dev.	Average	Std. Dev.	
NB	Left Turn	180	981	119	1,664	13	AVG
	Through	1,700	388	95	1,577	240	NO
	Right Turn	1,700	948	131	1,674	13	NO
SB	Left Turn	550	22	4	101	26	NO
	Through						
	Right Turn	550	206	98	718	154	MAX
EB	Left Turn	1,120	32	19	159	31	NO
	Through	1,120	136	7	626	65	NO
	Right Turn	810	11	2	234	73	NO
WB	Left Turn						
	Through	1,370	193	25	849	136	NO
	Right Turn	280	45	14	486	136	MAX

Intersection 24

I-80 WB Ramps/Douglas Blvd

Signalized

Direction	Movement	Storage (ft)	Average Queue (ft)		Maximum Queue (ft)		Exceeds Storage?
			Average	Std. Dev.	Average	Std. Dev.	
SB	Left Turn	1,530	67	66	296	41	NO
	Through	1,530	67	66	296	41	NO
	Right Turn	730	67	67	296	41	NO

Note: The "Average Queue" is calculated on a time-step basis so that queues when the approach is green (zero length) are included in the average.

VISSIM Post-Processor
 Average Results from 10 Runs
 Queue Length

SR 65 Widening
 Construction Year - GP Alternative
 PM Peak Hour

Intersection 25

I-80 EB Ramps/Douglas Blvd

Signalized

Direction	Movement	Storage (ft)	Average Queue (ft)		Maximum Queue (ft)		Exceeds Storage?
			Average	Std. Dev.	Average	Std. Dev.	
NB	Left Turn						
	Through						
	Right Turn	1,400	2	2	96	207	NO
SB	Left Turn						
	Through						
	Right Turn	1,250	320	202	1,009	640	NO

Intersection 30

I-80 WB Ramps/Rocklin Rd

Signalized

Direction	Movement	Storage (ft)	Average Queue (ft)		Maximum Queue (ft)		Exceeds Storage?
			Average	Std. Dev.	Average	Std. Dev.	
SB	Left Turn	700	24	6	187	90	NO
	Through						
	Right Turn	1,230	33	6	202	90	NO

Intersection 31

I-80 EB Ramps/Rocklin Rd

Signalized

Direction	Movement	Storage (ft)	Average Queue (ft)		Maximum Queue (ft)		Exceeds Storage?
			Average	Std. Dev.	Average	Std. Dev.	
NB	Left Turn	1,080	240	90	685	573	NO
	Through						
	Right Turn	1,080	237	90	683	574	NO

Note: The "Average Queue" is calculated on a time-step basis so that queues when the approach is green (zero length) are included in the average.

Intersection 33

Lincoln Blvd/SR-65 NB Off-Ramp

Signalized

Direction	Movement	Storage (ft)	Average Queue (ft)		Maximum Queue (ft)		Exceeds Storage?
			Average	Std. Dev.	Average	Std. Dev.	
WB	Left Turn	1,940	0	0	0	0	NO
	Through						
	Right Turn	1,940	0	0	8	25	NO

Intersection 35

SR-65 SB Ramps/Placer Pkwy

Signalized

Direction	Movement	Storage (ft)	Average Queue (ft)		Maximum Queue (ft)		Exceeds Storage?
			Average	Std. Dev.	Average	Std. Dev.	
SB	Left Turn	1,650	28	2	150	20	NO
	Through						
	Right Turn	1,650	28	2	150	20	NO

Intersection 36

SR-65 NB Ramps/Whitney Ranch Pkwy

Signalized

Direction	Movement	Storage (ft)	Average Queue (ft)		Maximum Queue (ft)		Exceeds Storage?
			Average	Std. Dev.	Average	Std. Dev.	
NB	Left Turn	1,620	35	4	216	47	NO
	Through						
	Right Turn	1,620	35	4	216	47	NO

Note: The "Average Queue" is calculated on a time-step basis so that queues when the approach is green (zero length) are included in the average.

SR 65 Capacity and Operational Improvements

**Vissim Model Results – Construction Year
Alternative 3 (No Build)**

VISSIM Post-Processor
Average Values from 10 Runs
Network Statistics

SR 65 Widening
Construction Year - No Build
AM Peak Period

Network Performance	Vehicle Types	Average	Std. Dev.
Number of Vehicles Served	All Vehicles	168,625	81
Travel Distance [mi]	All Vehicles	788,490	1,746
Travel Time [h]	All Vehicles	18,266	205.6
Average Speed [mph]	All Vehicles	43.2	0.5
Total Delay [h]	All Vehicles	4,733	205.6
Average Delay per Vehicle [s]	All Vehicles	99	4.3
VHD/VMT [min/mile]	All Vehicles	0.36	0.02
Number of Vehicles Served	HOV	32,341	38
Travel Distance [mi]	HOV	159,472	498
Travel Time [h]	HOV	3,489	30
Average Speed [mph]	HOV	45.7	0.4
Total Delay [h]	HOV	776	30
Average Delay per Vehicle [s]	HOV	84	3
VHD/VMT [min/mile]	HOV	0.29	0.01
Number of Vehicles Served	Truck	7,552	15
Travel Distance [mi]	Truck	37,920	331
Travel Time [h]	Truck	905	15
Average Speed [mph]	Truck	41.9	1
Total Delay [h]	Truck	249	12
Average Delay per Vehicle [s]	Truck	116	6
VHD/VMT [min/mile]	Truck	0.39	0.02

Performance Measure	Vehicle Types		
	HOV	Truck	All
Vehicles Served	32,340	7,550	168,620
Demand Volume	33,520	8,150	170,610
Percent Demand Served	96.5%	92.6%	98.8%
Vehicle Miles of Travel	159,470	37,920	788,490
Person Miles of Travel	334,890	39,820	965,810
Vehicle Hours of Travel	3,490	910	18,270
Vehicle Hours of Delay	780	250	4,730
VHD % of VHT	22.3%	27.5%	25.9%
Average Delay per Vehicle (min)	1.45	1.99	1.68
Person Hours of Delay	1,640	260	5,600
Average Travel Speed	45.7	41.9	43.2

VISSIM Post-Processor
Average Values from 10 Runs
Peak Hour Travel Time

SR 65 Widening
Construction Year - No Build
AM Peak Period

Mode	Description	Distance (ft)	Volume (vehicles)		Travel Time (min.:sec.)		Speed (mph)
			Average	Std. Dev.	Average	Std. Dev.	Average
SOV	SR-65 at Blue Oaks to I-80 at Antelope	43,046	826	14	09:16	00:26	21.1
	I-80 at Auburn to SR-65 at Blue Oaks	32,883	1,489	18	07:06	00:02	21.0
	I-80: Sierra College to Antelope	45,827	1,128	14	08:51	00:22	23.6
	I-80: Auburn to Sierra College	36,777	682	12	06:38	00:02	25.2
	SR-65: I-80 to Sunset	43,055	661	16	04:19	00:01	45.3
	SR-65: Sunset to Ferrari Ranch	45,816	178	6	03:31	00:01	59.1
	SR-65: Ferrari Ranch to Sunset	36,773	948	9	03:35	00:01	46.6
	SR-65: Sunset to I-80	32,884	1,203	17	05:12	00:21	28.8
HOV	SR-65 at Blue Oaks to I-80 at Antelope	43,046	248	5	08:54	00:13	45.3
	I-80 at Auburn to SR-65 at Blue Oaks	32,883	378	10	07:03	00:02	59.1
	I-80: Sierra College to Antelope	45,827	500	7	08:23	00:06	46.6
	I-80: Auburn to Sierra College	36,777	233	5	06:33	00:01	28.8
	SR-65: I-80 to Sunset	43,055	157	5	04:19	00:02	22.0
	SR-65: Sunset to Ferrari Ranch	45,816	37	3	03:30	00:02	21.2
	SR-65: Ferrari Ranch to Sunset	36,773	109	4	03:35	00:00	24.9
	SR-65: Sunset to I-80	32,884	373	8	05:11	00:23	25.5

VISSIM Post-Processor
Average Values from 10 Runs
Network Statistics

SR 65 Widening
Construction Year - No Build Alternative
PM Peak Period

Network Performance	Vehicle Types	Average	Std. Dev.
Number of Vehicles Served	All Vehicles	233,868	256
Travel Distance [mi]	All Vehicles	909,556	2,008
Travel Time [h]	All Vehicles	25,868	397.3
Average Speed [mph]	All Vehicles	35.2	0.6
Total Delay [h]	All Vehicles	9,844	425.5
Average Delay per Vehicle [s]	All Vehicles	149	6.4
VHD/VMT [min/mile]	All Vehicles	0.65	0.03
Number of Vehicles Served	HOV	46,090	82
Travel Distance [mi]	HOV	192,613	728
Travel Time [h]	HOV	4,875	37
Average Speed [mph]	HOV	39.5	0.3
Total Delay [h]	HOV	1,512	34
Average Delay per Vehicle [s]	HOV	116	3
VHD/VMT [min/mile]	HOV	0.47	0.01
Number of Vehicles Served	Truck	9,024	30
Travel Distance [mi]	Truck	36,753	284
Travel Time [h]	Truck	1,121	30
Average Speed [mph]	Truck	32.8	1
Total Delay [h]	Truck	468	32
Average Delay per Vehicle [s]	Truck	183	13
VHD/VMT [min/mile]	Truck	0.76	0.05

Performance Measure	Vehicle Types		
	HOV	Truck	All
Vehicles Served	46,090	9,020	233,870
Demand Volume	47,310	9,670	235,630
Percent Demand Served	97.4%	93.3%	99.3%
Vehicle Miles of Travel	192,610	36,750	909,560
Person Miles of Travel	404,490	38,590	1,123,280
Vehicle Hours of Travel	4,870	1,120	25,870
Vehicle Hours of Delay	1,510	470	9,840
VHD % of VHT	31.0%	42.0%	38.0%
Average Delay per Vehicle (min)	1.97	3.13	2.52
Person Hours of Delay	3,170	490	11,520
Average Travel Speed	39.5	32.8	35.2

VISSIM Post-Processor
Average Values from 10 Runs
Peak Hour Travel Time

SR 65 Widening
Construction Year - No Build Alternative
PM Peak Period

Mode	Description	Distance (ft)	Volume (vehicles)		Travel Time (min.:sec.)		Speed (mph)
			Average	Std. Dev.	Average	Std. Dev.	Average
SOV	SR-65 at Blue Oaks to I-80 at Antelope	43,046	657	10	08:17	00:01	23.6
	I-80 at Auburn to SR-65 at Blue Oaks	32,882	1,494	14	17:23	01:31	8.6
	I-80: Sierra College to Antelope	45,827	498	10	08:16	00:01	25.2
	I-80: Auburn to Sierra College	36,777	706	13	16:25	01:30	10.2
	SR-65: I-80 to Sunset	43,055	1,180	18	04:22	00:01	44.9
	SR-65: Sunset to Ferrari Ranch	45,816	249	7	03:34	00:00	58.4
	SR-65: Ferrari Ranch to Sunset	36,773	590	10	03:31	00:00	47.5
	SR-65: Sunset to I-80	32,883	782	13	04:11	00:01	35.8
HOV	SR-65 at Blue Oaks to I-80 at Antelope	43,046	119	6	08:15	00:03	44.9
	I-80 at Auburn to SR-65 at Blue Oaks	32,882	573	12	09:38	00:21	58.4
	I-80: Sierra College to Antelope	45,827	199	6	08:08	00:02	47.5
	I-80: Auburn to Sierra College	36,777	282	8	08:12	00:22	35.8
	SR-65: I-80 to Sunset	43,055	419	9	04:21	00:01	23.7
	SR-65: Sunset to Ferrari Ranch	45,816	52	3	03:34	00:01	15.5
	SR-65: Ferrari Ranch to Sunset	36,773	94	4	03:31	00:01	25.6
	SR-65: Sunset to I-80	32,883	200	7	04:11	00:01	20.4

VISSIM Post-Processor
Average Results from 10 Runs
Freeway Operations Summary

SR 65 Widening
Construction Year - No Build
AM Peak Hour

Location	Facility Type	Mainline Volume (vph)			On-ramp Volume (vph)			Off-ramp Volume (vph)			Speed (mph)		Density (vplpm)		LOS		
		Avg.	St. Dev.	%	Avg.	St. Dev.	%	Avg.	St. Dev.	%	Avg.	St. Dev.	Avg.	St. Dev.			
1 I-80 EB - Auburn Blvd On-ramp	Merge	7,239	35	110.0%	1,014	12	109.1%				62.1	0.3	28.7	0.3	D		
2 I-80 EB - Auburn Blvd to Douglas Blvd	Basic	8,245	67	109.8%							53.7	3.7	38.8	3.1	E		
3 I-80 EB - Douglas Blvd Slip Off	Diverge	8,241	90	109.7%				1,434	83	109.4%	60.3	1.3	29.4	1.1	D		
4 I-80 EB - Douglas Blvd WB Off-ramp	Diverge	6,800	99	109.7%				575	47	108.5%	62.8	0.4	22.3	0.7	C		
5 I-80 EB - Douglas Blvd Off to On-ramp	Basic	6,221	97	109.7%							63.2	0.1	24.6	0.3	C		
6 I-80 EB - Douglas Blvd On-ramp	Merge	6,220	100	109.7%	822	23	91.3%				62.2	0.5	27.7	0.9	C		
7 I-80 EB - Eureka Rd Off-ramp	Diverge	7,044	100	107.2%						1,375	79	107.4%	61.7	0.5	28.9	0.9	D
8 I-80 EB - Eureka Rd Off to On-ramp	Basic	5,667	83	107.1%							63.2	0.2	23.9	0.4	C		
9 I-80 EB - Eureka Rd EB On-ramp	Merge	5,669	93	107.2%	174	6	96.8%				63.3	0.1	21.9	0.7	C		
10 I-80 EB - Eureka Rd to Taylor Rd	Weave	5,847	93	106.9%	458	34	101.7%	359	33	105.5%	62.7	0.3	24.4	0.5	C		
11 I-80 EB - Taylor Rd to SR 65	Basic	5,946	107	106.6%							60.8	0.5	30.4	0.5	D		
17 I-80 EB - SR 65 Off-ramp	Diverge	5,945	104	106.5%						3,119	105	106.8%	61.1	0.4	31.0	0.7	D
18 I-80 EB - SR 65 Off to On-ramp	Basic	2,827	85	106.3%							64.0	0.1	15.4	0.5	B		
19 I-80 EB - SR-65 On-ramp	Merge	2,826	83	106.2%	1,408	66	104.3%				63.0	0.2	21.6	0.5	C		
21 I-80 EB - SR-65 to Rocklin Rd	Basic	4,241	103	105.8%							63.6	0.1	20.5	0.4	C		
22 I-80 EB - Rocklin Rd Off-ramp	Diverge	4,250	111	106.0%						1,473	66	103.7%	63.6	0.3	20.2	0.4	C
23 I-80 EB - Rocklin Rd Off to On-ramp	Basic	2,779	95	107.3%							63.8	0.3	17.1	0.7	B		
24 I-80 EB - Rocklin Rd On-ramp	Merge	2,781	97	107.4%	239	8	95.7%				61.2	0.5	17.5	0.6	B		
25 I-80 EB - Rocklin Rd to Sierra College Blvd	Basic	3,021	104	106.4%							63.6	0.2	18.2	0.7	C		
26 I-80 EB - Sierra College Blvd Off-ramp	Diverge	3,022	101	106.4%						399	49	105.0%	63.1	0.5	19.2	0.7	B
27 I-80 EB - Sierra College Blvd Off to On-ramp	Basic	2,628	96	106.8%							63.7	0.3	16.8	0.6	B		
28 I-80 EB - Sierra College Blvd SB On-ramp	Merge	2,631	97	107.0%	131	4	100.8%				62.9	0.2	15.8	0.7	B		
29 I-80 EB - Sierra College Blvd NB On-ramp	Merge	2,761	101	106.6%	356	15	93.7%				62.6	0.3	17.4	0.6	B		
38 I-80 WB - Sierra College Blvd Off-ramp	Diverge	4,934	23	105.9%						846	49	105.7%	56.9	1.7	28.1	0.9	D
39 I-80 WB - Sierra College Blvd Off to On-ramp	Basic	4,087	69	105.9%							61.8	0.6	25.0	0.5	C		
40 I-80 WB - Sierra College Blvd NB On-ramp	Merge	4,090	71	106.0%	51	4	84.8%				62.9	0.4	22.2	0.4	C		
41 I-80 WB - Sierra College Blvd SB On-ramp	Merge	4,140	75	105.6%	308	7	102.5%				61.3	1.1	23.8	0.5	C		
42 I-80 WB - Sierra College Blvd to Rocklin Rd	Basic	4,446	85	105.3%							62.3	0.2	26.9	0.4	D		
43 I-80 WB - Rocklin Rd Off-ramp	Diverge	4,444	81	105.3%						248	33	107.7%	61.4	0.4	27.6	0.5	C
44 I-80 WB - Rocklin Rd Off to On-ramp	Basic	4,198	93	105.2%							63.0	0.1	25.2	0.4	C		
45 I-80 WB - Rocklin Rd On-ramp	Merge	4,197	93	105.2%	905	50	99.4%				60.4	1.4	26.8	0.7	C		
46 I-80 WB - Rocklin Rd to HOV Lane Start	Basic	5,087	127	103.8%							62.1	0.8	29.0	0.6	D		
47 I-80 WB - HOV Lane Start to SR-65	Basic	5,082	136	103.7%							62.0	0.4	24.0	0.5	C		
48 I-80 WB - SR-65 Off-ramp	Diverge	5,085	134	103.8%						1,452	73	105.2%	63.4	0.4	22.1	0.5	C
49 I-80 WB - SR-65 Off to On-ramp	Basic	3,630	102	103.1%							63.6	0.1	19.7	0.6	C		
50 I-80 WB - SR-65 On-ramp	Merge	3,628	103	103.1%	3,836	112	104.5%				60.5	0.6	29.3	0.9	D		
60 I-80 WB - Taylor Rd On-ramp	Merge	7,462	136	103.8%	618	39	108.5%				56.3	3.2	36.4	2.8	E		
61 I-80 WB - Atlantic St WB Off-ramp	Diverge	8,076	131	104.1%						334	37	104.4%	59.5	2.1	35.8	1.4	E
62 I-80 WB - Atlantic St EB Off-ramp	Diverge	7,739	127	104.0%						993	51	102.3%	59.7	2.4	35.6	1.4	E
63 I-80 WB - Atlantic St EB Off to On-ramp	Basic	6,741	117	104.2%							62.8	0.1	27.1	0.5	D		
64 I-80 WB - Atlantic St On-ramp	Merge	6,740	107	104.2%	1,169	66	107.2%				56.8	3.7	37.7	2.8	E		
65 I-80 WB - Douglas Blvd Off-ramp	Diverge	7,904	113	104.5%						929	54	102.1%	59.8	0.7	33.2	0.7	D
66 I-80 WB - Douglas Blvd Off to On-ramp	Basic	6,974	122	104.9%							62.6	0.3	28.5	0.4	D		
67 I-80 WB - Douglas Blvd WB On-ramp	Merge	6,974	124	104.9%	1,019	41	107.3%				57.0	2.2	32.1	1.8	D		
68 I-80 WB - Douglas Blvd Slip On	Merge	7,993	134	105.2%	454	31	105.5%				53.5	7.2	39.3	6.6	E		
69 I-80 WB - Douglas Blvd to Riverside Ave	Basic	8,440	138	105.1%							61.5	0.4	33.6	0.4	D		
70 I-80 WB - Riverside Ave Off-ramp	Diverge	8,441	138	105.1%						925	52	100.6%	62.2	0.3	33.0	0.8	D
71 I-80 WB - Riverside Ave Off to On-ramp	Basic	7,517	129	105.7%							62.7	0.1	29.7	0.3	D		
72 I-80 WB - Riverside Ave NB On-ramp	Merge	7,518	125	105.7%	283	6	83.3%				63.0	0.1	27.4	0.7	C		
73 I-80 WB - Riverside Ave SB On-ramp	Merge	7,800	111	104.7%	857	16	102.0%				55.7	11.2	38.2	12.9	E		
74 I-80 WB - Riverside Ave to Antelope Rd	Basic	8,659	131	104.5%							44.8	13.6	52.2	17.8	F		
75 I-80 WB - Antelope Rd Off-ramp	Diverge	8,659	192	104.5%						349	29	91.9%	40.5	13.7	61.1	18.8	F
76 I-80 WB - Antelope Rd Off to On-ramp	Basic	8,306	232	105.0%							35.3	14.0	71.8	23.5	F		
77 I-80 WB - Antelope Rd WB On-ramp	Merge	8,308	257	105.0%	566	13	97.6%				30.0	10.0	87.5	24.0	F		
78 I-80 WB - Antelope Rd to Truck Scales	Weave	8,908	235	104.9%	445	11	96.6%	91	19	83.1%	30.7	4.2	75.4	8.3	F		
79 I-80 WB - Truck Scales Off to On-ramp	Basic	9,396	213	106.3%							30.1	0.7	83.2	2.2	F		
80 I-80 WB - Truck Scales On-ramp	Merge	9,439	215	106.8%	92	20	83.5%				28.7	0.9	94.9	2.5	F		
81 I-80 WB - Truck Scales to Elkhorn Blvd	Basic	9,580	169	107.0%							31.9	1.1	73.5	2.2	F		
82 I-80 WB - Elkhorn Blvd Off-ramp	Diverge	9,591	156	107.2%						809	52	109.4%	32.3	1.4	61.8	3.8	F
83 I-80 WB - Elkhorn Blvd Off to On-ramp	Basic	8,831	115	107.6%							26.5	0.4	92.7	2.0	F		
84 I-80 WB - Elkhorn Blvd WB On-ramp	Merge	8,829	110	107.5%	802	10	95.5%				26.6	0.3	96.2	1.3	F		
85 I-80 WB - Elkhorn Blvd EB On-ramp	Merge	9,647	105	106.6%	881	26	95.8%				32.7	0.3	77.0	0.8	F		

Notes: Average density reported for the analysis area only: for example, within the ramp influence area and not including the HOV lane.
Mainline volume is the upstream served volume for all lanes.

VISSIM Post-Processor
Average Results from 10 Runs
Freeway Operations Summary

SR 65 Widening
Construction Year - No Build
AM Peak Hour

Location	Facility Type	Mainline Volume (vph)			On-ramp Volume (vph)			Off-ramp Volume (vph)			Speed (mph)		Density (vplpm)		LOS
		Avg.	St. Dev.	%	Avg.	St. Dev.	%	Avg.	St. Dev.	%	Avg.	St. Dev.	Avg.	St. Dev.	
100 SR-65 NB - EB I-80 Connector	Basic	3,117	107	106.7%							41.6	1.3	44.2	2.4	E
101 SR-65 NB - WB I-80 Connector	Basic	1,451	72	105.2%							51.1	0.4	24.5	0.9	C
103 SR-65 NB - I-80 WB On-ramp	Merge	3,113	109	106.6%	1,451	72	105.2%				60.8	0.7	28.2	0.8	D
104 SR-65 NB - I-80 to Stanford Ranch Rd	Basic	4,568	131	106.2%							63.1	0.2	26.9	0.8	D
105 SR-65 NB - Stanford Ranch Rd Off-ramp	Diverge	4,568	132	106.2%				734	54	101.9%	62.8	0.3	23.9	1.0	C
106 SR-65 NB - Stanford Ranch Rd Off to On-ramp	Basic	3,838	119	107.2%							63.1	0.2	23.2	0.7	C
107 SR-65 NB - Stanford Ranch Rd On-ramp	Merge	3,839	117	107.2%	752	40	104.4%				57.7	2.0	31.3	1.6	D
109 SR-65 NB - Pleasant Grove Blvd Off-ramp	Diverge	4,591	141	106.8%				709	54	98.4%	58.3	1.2	35.6	1.9	E
110 SR-65 NB - Pleasant Grove Blvd Off to On-ramp	Basic	3,882	144	108.4%							61.6	0.5	35.8	1.5	E
111 SR-65 NB - Pleasant Grove Blvd to Blue Oaks Blvd	Weave	3,880	141	108.4%	234	25	101.7%	1,805	75	108.7%	62.8	0.1	26.9	0.9	C
114 SR-65 NB - Blue Oaks Blvd Off to On-ramp	Basic	2,310	88	107.4%							63.5	0.1	20.1	0.7	C
115 SR-65 NB - Blue Oaks Blvd On-ramp	Merge	2,310	87	107.4%	467	35	99.3%				60.7	0.5	22.2	1.1	C
116 SR-65 NB - Blue Oaks Blvd to Sunset Blvd	Basic	2,778	97	106.0%							62.1	0.3	25.2	1.3	C
118 SR-65 NB - Sunset Blvd Off-ramp	Diverge	2,776	100	105.9%				1,194	67	105.7%	63.6	0.2	19.4	1.1	B
119 SR-65 NB - Sunset Blvd Off to On-ramp	Basic	1,583	82	106.2%							63.9	0.2	13.9	0.9	B
120 SR-65 NB - Sunset Blvd EB On-ramp	Merge	1,582	78	106.1%	46	12	92.6%				63.8	0.2	13.8	0.8	B
121 SR-65 NB - Sunset Blvd to Whitney Ranch Pkwy	Weave	1,629	77	105.8%	242	11	105.3%	321	37	97.4%	63.5	0.1	13.4	0.5	B
124 SR-65 NB - Whitney Ranch Pkwy Off to On-ramp	Basic	1,552	69	107.7%							63.6	0.1	13.6	0.4	B
125 SR-65 NB - Whitney Ranch Pkwy EB On-ramp	Merge	1,553	69	107.8%	184	14	97.0%				63.2	0.2	14.0	0.4	B
126 SR-65 NB - Whitney Ranch Pkwy WB On-ramp	Merge	1,737	74	106.6%	211	14	105.5%				63.1	0.2	16.4	0.4	B
127 SR-65 NB - Whitney Ranch Pkwy to Twelve Bridges Dr	Basic	1,948	80	106.5%							63.3	0.2	16.8	0.5	B
128 SR-65 NB - Twelve Bridges Dr Off-ramp	Diverge	1,948	78	106.5%				409	38	95.0%	63.1	0.2	17.1	0.6	B
129 SR-65 NB - Twelve Bridges Dr Off to On-ramp	Basic	1,542	76	110.2%							63.6	0.2	14.0	0.6	B
130 SR-65 NB - Twelve Bridges Dr to Lincoln Blvd	Weave	1,546	68	110.4%	270	28	108.2%	641	46	112.5%	63.6	0.3	12.5	0.4	B
133 SR-65 NB - Lincoln Blvd to Ferrari Ranch Rd	Basic	945	56	87.5%							64.0	0.2	12.3	0.5	B
134 SR-65 NB - Ferrari Ranch Rd Off-ramp	Diverge	1,177	63	108.9%				667	53	104.3%	64.4	0.2	10.1	0.4	B
135 SR-65 NB - Ferrari Ranch Rd Off to On-ramp	Basic	512	42	116.4%							64.5	0.3	4.9	0.5	A
136 SR-65 NB - Ferrari Ranch Rd On-ramp	Merge	513	44	116.7%	114	6	103.5%				62.4	0.3	5.4	0.5	A
150 SR-65 SB - Ferrari Ranch Rd Off-ramp	Diverge	990	26	112.5%				71	16	101.7%	64.3	0.2	11.2	0.2	B
151 SR-65 SB - Ferrari Ranch Rd Off to On-ramp	Basic	919	27	113.5%							64.3	0.1	10.3	0.3	A
152 SR-65 SB - Ferrari Ranch Rd WB On-ramp	Merge	919	29	113.5%	886	18	108.1%				60.3	0.2	13.8	0.3	B
153 SR-65 SB - Ferrari Ranch Rd EB On-ramp	Merge	1,807	37	110.8%	697	22	92.9%				60.3	0.3	18.6	0.5	B
154 SR-65 SB - Ferrari Ranch Rd to Lane Drop	Basic	2,505	46	105.3%							62.5	0.6	26.4	0.6	D
155 SR-65 SB - Lane Drop to Lincoln Blvd	Basic	2,505	49	105.3%							63.0	0.4	26.2	0.6	D
156 SR-65 SB - Lincoln Blvd to Twelve Bridges Dr	Weave	2,507	48	105.3%	873	50	106.5%	349	34	108.9%	60.8	0.7	25.4	0.6	C
159 SR-65 SB - Twelve Bridges Dr Off to On-ramp	Basic	3,032	67	105.3%							62.2	0.3	28.5	0.5	D
160 SR-65 SB - Twelve Bridges Dr On-ramp	Merge	3,031	69	105.2%	598	25	112.8%				58.2	2.3	32.6	1.7	D
161 SR-65 SB - Twelve Bridges Dr to Placer Pkwy	Basic	3,628	80	106.4%							61.5	0.3	33.6	0.6	D
162 SR-65 SB - Placer Pkwy Off-ramp	Diverge	3,625	87	106.3%				393	37	109.0%	62.2	0.1	31.0	0.6	D
163 SR-65 SB - Placer Pkwy Off to On-ramp	Basic	3,228	90	105.8%							62.6	0.1	28.3	0.7	D
164 SR-65 SB - Placer Pkwy WB On-ramp	Merge	3,224	91	105.7%	255	30	106.0%				62.6	0.3	28.9	0.6	D
165 SR-65 SB - Placer Pkwy to Sunset Blvd	Weave	3,479	93	105.8%	216	14	113.5%	549	44	103.6%	61.6	0.3	27.5	0.5	C
168 SR-65 SB - Sunset Blvd Off to On-ramp	Basic	3,146	102	106.7%							62.4	0.2	27.6	0.8	D
169 SR-65 SB - Sunset Blvd WB On-ramp	Merge	3,146	102	106.6%	292	24	112.2%				60.0	5.0	28.7	3.1	D
170 SR-65 SB - Sunset Blvd EB On-ramp	Merge	3,438	101	107.1%	346	18	101.8%				50.8	13.2	41.6	14.0	E
171 SR-65 SB - Sunset Blvd to Blue Oaks Blvd	Basic	3,786	104	106.7%							47.0	15.0	48.4	20.1	F
172 SR-65 SB - Blue Oaks Blvd Off-ramp	Diverge	3,786	106	106.7%				637	46	106.1%	37.0	14.3	60.4	20.2	F
173 SR-65 SB - Blue Oaks Blvd Off to On-ramp	Basic	3,142	92	106.5%							17.6	3.0	96.2	11.5	F
174 SR-65 SB - Blue Oaks Blvd WB On-ramp	Merge	3,134	93	106.2%	456	4	99.0%				20.8	1.4	80.9	3.6	F
175 SR-65 SB - Blue Oaks Blvd to Pleasant Grove Blvd	Weave	3,573	98	104.8%	1,212	59	101.9%	640	51	104.8%	35.8	0.8	56.5	1.4	F
178 SR-65 SB - Pleasant Grove Blvd Off to On-ramp	Basic	4,139	84	103.7%							59.6	1.0	35.5	1.0	E
179 SR-65 SB - Pleasant Grove Blvd WB On-ramp	Merge	4,136	83	103.7%	745	42	102.1%				61.7	0.4	29.5	0.4	D
180 SR-65 SB - Pleasant Grove Blvd EB On-ramp	Merge	4,879	94	103.4%	655	38	102.3%				59.3	2.9	29.9	1.9	D
181 SR-65 SB - Pleasant Grove Blvd to Galleria Blvd	Basic	5,531	99	103.2%							61.3	0.6	31.3	0.6	D
182 SR-65 SB - Galleria Blvd Off-ramp	Diverge	5,531	101	103.2%				1,013	59	97.4%	62.1	0.5	31.7	0.6	D
183 SR-65 SB - Galleria Blvd Off to On-ramp	Basic	4,516	96	104.5%							61.5	1.2	29.1	0.8	D
185 SR-65 SB - Galleria Blvd On-ramp	Merge	4,517	99	104.6%	721	40	103.0%				53.6	5.9	39.4	4.8	E
186 SR-65 SB - I-80 Off-ramp	Diverge	5,238	126	104.4%				3,834	107	104.5%	60.0	0.7	32.0	0.8	D
187 SR-65 SB - EB I-80 Connector (2 lanes)	Basic	1,409	64	104.4%							60.7	0.4	26.4	0.8	D
188 SR-65 SB - EB I-80 Connector (1 lane)	Basic	1,407	64	104.3%							61.8	0.2	26.0	0.8	D
189 SR-65 SB - WB I-80 Connector	Basic	3,837	109	104.5%							51.8	0.3	38.5	1.2	E

Notes: Average density reported for the analysis area only: for example, within the ramp influence area and not including the HOV lane.
Mainline volume is the upstream served volume for all lanes.

Location	Facility Type	Mainline Volume (vph)			On-ramp Volume (vph)			Off-ramp Volume (vph)			Speed (mph)		Density (vplpm)		LOS
		Avg.	St. Dev.	%	Avg.	St. Dev.	%	Avg.	St. Dev.	%	Avg.	St. Dev.	Avg.	St. Dev.	
1 I-80 EB - Auburn Blvd On-ramp	Merge	7,543	182	100.4%	898	40	94.6%				36.9	16.6	72.4	36.2	F
2 I-80 EB - Auburn Blvd to Douglas Blvd	Basic	8,267	392	97.7%							31.1	10.7	80.7	26.3	F
3 I-80 EB - Douglas Blvd Slip Off	Diverge	8,210	427	97.0%				1,100	82	94.8%	29.3	3.8	75.8	11.7	F
4 I-80 EB - Douglas Blvd WB Off-ramp	Diverge	7,053	375	96.6%				677	82	95.4%	22.6	0.9	129.9	7.5	F
5 I-80 EB - Douglas Blvd Off to On-ramp	Basic	6,266	378	95.1%							22.8	0.8	126.2	5.2	F
6 I-80 EB - Douglas Blvd On-ramp	Merge	6,220	410	94.4%	1,129	65	86.1%				15.2	1.4	128.6	5.3	F
7 I-80 EB - Eureka Rd Off-ramp	Diverge	7,300	389	92.4%				1,024	97	93.1%	19.9	1.6	106.0	4.5	F
8 I-80 EB - Eureka Rd Off to On-ramp	Basic	6,286	298	92.4%							20.8	0.5	125.2	3.8	F
9 I-80 EB - Eureka Rd EB On-ramp	Merge	6,293	307	92.5%	320	22	103.1%				16.0	0.6	131.5	3.5	F
10 I-80 EB - Eureka Rd to Taylor Rd	Weave	6,629	300	93.2%	1,130	64	103.7%	519	57	89.5%	18.3	0.4	121.3	2.5	F
11 I-80 EB - Taylor Rd to SR-65	Basic	7,237	267	95.0%							19.1	1.6	109.0	5.0	F
17 I-80 EB - SR-65 Off-ramp	Diverge	7,239	271	95.0%				3,883	90	96.1%	24.8	2.2	92.0	5.5	F
18 I-80 EB - SR-65 Off to On-ramp	Basic	3,347	203	93.5%							62.7	0.4	17.0	1.0	B
19 I-80 EB - SR-65 On-ramp	Merge	3,343	204	93.4%	1,844	80	96.0%				62.3	0.9	23.1	0.9	C
21 I-80 EB - SR-65 to Rocklin Rd	Basic	5,183	194	94.2%							63.0	0.2	23.1	0.7	C
22 I-80 EB - Rocklin Rd Off-ramp	Diverge	5,182	189	94.2%				1,619	82	95.8%	63.3	0.2	21.0	0.7	C
23 I-80 EB - Rocklin Rd Off to On-ramp	Basic	3,554	155	93.3%							63.4	0.1	21.0	0.9	C
24 I-80 EB - Rocklin Rd On-ramp	Merge	3,554	152	93.3%	280	26	107.8%				60.4	0.6	21.1	0.7	C
25 I-80 EB - Rocklin Rd to Sierra College Blvd	Basic	3,825	150	94.0%							63.2	0.1	21.9	0.7	C
26 I-80 EB - Sierra College Blvd Off-ramp	Diverge	3,823	151	93.9%				286	40	89.5%	62.3	0.5	23.4	0.9	C
27 I-80 EB - Sierra College Blvd Off to On-ramp	Basic	3,534	156	94.2%							63.1	0.4	20.7	0.8	C
28 I-80 EB - Sierra College Blvd SB On-ramp	Merge	3,533	154	94.2%	236	3	94.4%				61.3	0.5	19.7	0.9	B
29 I-80 EB - Sierra College Blvd NB On-ramp	Merge	3,764	142	94.1%	579	24	96.5%				61.3	0.4	22.7	0.7	C
38 I-80 WB - Sierra College Blvd Off-ramp	Diverge	3,662	15	105.8%				584	42	106.2%	60.7	0.7	19.3	0.4	B
39 I-80 WB - Sierra College Blvd Off to On-ramp	Basic	3,077	53	105.7%							63.7	0.3	18.0	0.3	B
40 I-80 WB - Sierra College Blvd NB On-ramp	Merge	3,076	48	105.7%	151	5	100.6%				63.2	0.3	16.5	0.3	B
41 I-80 WB - Sierra College Blvd SB On-ramp	Merge	3,227	57	105.5%	223	5	92.9%				63.1	0.2	17.5	0.4	B
42 I-80 WB - Sierra College Blvd to Rocklin Rd	Basic	3,448	63	104.5%							63.4	0.1	19.7	0.2	C
43 I-80 WB - Rocklin Rd Off-ramp	Diverge	3,446	61	104.4%				283	39	104.7%	62.9	0.3	20.6	0.5	C
44 I-80 WB - Rocklin Rd Off to On-ramp	Basic	3,163	55	104.4%							63.6	0.1	18.5	0.3	C
45 I-80 WB - Rocklin Rd On-ramp	Merge	3,164	59	104.4%	1,323	50	97.3%				60.5	0.5	22.6	0.3	C
46 I-80 WB - Rocklin Rd to HOV Lane Start	Basic	4,478	85	102.0%							62.9	0.3	24.2	0.4	C
47 I-80 WB - HOV Lane Start to SR-65	Basic	4,476	91	102.0%							62.8	0.3	20.1	0.4	C
48 I-80 WB - SR-65 Off-ramp	Diverge	4,474	90	101.9%				1,724	72	102.0%	63.9	0.2	18.1	0.4	B
49 I-80 WB - SR-65 Off to On-ramp	Basic	2,743	78	101.6%							63.9	0.1	15.5	0.4	B
50 I-80 WB - SR-65 On-ramp	Merge	2,741	77	101.5%	3,213	108	100.1%				61.9	0.2	24.7	0.6	C
60 I-80 WB - Taylor Rd On-ramp	Merge	5,958	136	100.8%	425	43	78.8%				61.7	0.3	28.1	0.9	D
61 I-80 WB - Atlantic St WB Off-ramp	Diverge	6,388	152	99.0%				390	31	102.5%	62.9	0.6	27.1	0.7	C
62 I-80 WB - Atlantic St EB Off-ramp	Diverge	6,000	143	98.8%				956	62	100.6%	62.8	0.4	28.1	0.8	D
63 I-80 WB - Atlantic St Off to On-ramp	Basic	5,039	135	98.4%							63.5	0.1	20.4	0.5	C
64 I-80 WB - Atlantic St On-ramp	Merge	5,040	141	98.4%	1,394	70	102.5%				60.4	1.3	29.6	0.8	D
65 I-80 WB - Douglas Blvd Off-ramp	Diverge	6,438	153	99.3%				904	71	98.3%	61.9	0.9	27.3	0.7	C
66 I-80 WB - Douglas Blvd Off to On-ramp	Basic	5,528	134	99.4%							63.5	0.1	22.6	0.6	C
67 I-80 WB - Douglas Blvd WB On-ramp	Merge	5,526	136	99.4%	1,411	70	100.1%				57.9	1.3	26.9	0.9	C
68 I-80 WB - Douglas Blvd Slip On	Merge	6,929	171	99.4%	723	42	87.2%				60.2	1.6	30.7	1.3	D
69 I-80 WB - Douglas Blvd to Riverside Ave	Basic	7,662	162	98.2%							62.1	0.3	30.2	0.8	D
70 I-80 WB - Riverside Ave Off-ramp	Diverge	7,666	154	98.3%				1,167	62	100.6%	62.7	0.1	31.2	0.7	D
71 I-80 WB - Riverside Ave Off to On-ramp	Basic	6,494	175	97.8%							63.2	0.1	24.9	0.7	C
72 I-80 WB - Riverside Ave NB On-ramp	Merge	6,488	173	97.7%	206	1	98.0%				63.3	0.1	23.0	0.8	C
73 I-80 WB - Riverside Ave SB On-ramp	Merge	6,693	178	97.7%	578	7	99.7%				61.5	1.2	27.2	0.8	C
74 I-80 WB - Riverside Ave to Antelope Rd	Basic	7,267	178	97.8%							62.0	0.6	28.1	0.8	D
75 I-80 WB - Antelope Rd Off-ramp	Diverge	7,274	155	97.9%				942	59	98.2%	61.9	1.4	29.3	1.0	D
76 I-80 WB - Antelope Rd Off to On-ramp	Basic	6,334	149	97.9%							62.8	0.4	24.4	0.7	C
77 I-80 WB - Antelope Rd WB On-ramp	Merge	6,334	150	97.9%	373	8	98.2%				60.7	0.9	22.9	0.9	C
78 I-80 WB - Antelope Rd to Truck Scales	Weave	6,702	151	97.8%	368	15	99.5%	61	15	100.8%	62.7	0.3	23.9	0.6	C
79 I-80 WB - Truck Scales Off to On-ramp	Basic	7,011	154	97.9%							63.0	0.1	26.2	0.6	D
80 I-80 WB - Truck Scales On-ramp	Merge	7,015	152	98.0%	61	14	101.2%				62.7	0.1	26.7	0.4	C
81 I-80 WB - Truck Scales to Elkhorn Blvd	Basic	7,071	160	97.9%							62.0	0.3	27.5	0.7	D
82 I-80 WB - Elkhorn Blvd Off-ramp	Diverge	7,072	158	98.0%				1,047	65	95.1%	62.6	0.2	25.6	0.7	C
83 I-80 WB - Elkhorn Blvd Off to On-ramp	Basic	6,024	129	98.4%							63.3	0.2	23.1	0.5	C
84 I-80 WB - Elkhorn Blvd WB On-ramp	Merge	6,022	131	98.4%	898	3	99.8%				58.5	0.7	24.6	0.7	C
85 I-80 WB - Elkhorn Blvd EB On-ramp	Merge	6,925	133	98.6%	658	16	102.8%				61.8	0.6	28.3	0.7	D

Notes: Average density reported for the analysis area only: for example, within the ramp influence area and not including the HOV lane.
Mainline volume is the upstream served volume for all lanes.

	Location	Facility Type	Mainline Volume (vph)			On-ramp Volume (vph)			Off-ramp Volume (vph)			Speed (mph)		Density (vplpm)		LOS
			Avg.	St. Dev.	%	Avg.	St. Dev.	%	Avg.	St. Dev.	%	Avg.	St. Dev.	Avg.	St. Dev.	
100	SR-65 NB - EB I-80 Connector	Basic	3,881	86	96.1%							36.1	0.7	61.5	1.7	F
101	SR-65 NB - WB I-80 Connector	Basic	1,724	72	102.0%							50.3	0.4	27.8	0.9	D
103	SR-65 NB - I-80 On-ramp	Merge	3,879	85	96.0%	1,723	69	102.0%				60.2	0.5	32.3	0.4	D
104	SR-65 NB - I-80 to Stanford Ranch Rd	Basic	5,605	114	97.8%							62.7	0.2	30.6	0.3	D
105	SR-65 NB - Stanford Ranch Rd Off-ramp	Diverge	5,604	115	97.8%				1,158	67	95.7%	62.1	0.5	29.5	0.2	D
106	SR-65 NB - Stanford Ranch Rd Off to On-ramp	Basic	4,441	117	98.2%							62.8	0.4	24.7	0.4	C
107	SR-65 NB - Stanford Ranch Rd On-ramp	Merge	4,441	117	98.2%	904	44	97.2%				56.9	3.2	32.5	1.7	D
109	SR-65 NB - Pleasant Grove Blvd Off-ramp	Diverge	5,338	110	98.0%				1,132	57	96.7%	58.3	1.0	35.8	1.1	E
110	SR-65 NB - Pleasant Grove Blvd Off to On-ramp	Basic	4,206	110	98.3%							61.8	0.4	35.8	0.7	E
111	SR-65 NB - Pleasant Grove Blvd to Blue Oaks Blvd	Weave	4,207	110	98.3%	596	30	99.3%	1,786	85	99.2%	62.2	0.3	28.7	0.5	D
114	SR-65 NB - Blue Oaks Blvd Off to On-ramp	Basic	3,019	92	98.0%							63.0	0.1	25.0	0.6	C
115	SR-65 NB - Blue Oaks Blvd On-ramp	Merge	3,016	96	97.9%	488	36	101.6%				60.9	0.5	27.5	0.8	C
116	SR-65 NB - Blue Oaks Blvd to Sunset Blvd	Basic	3,501	104	98.3%							62.2	0.2	29.4	0.8	D
118	SR-65 NB - Sunset Blvd Off-ramp	Diverge	3,501	101	98.3%				609	30	101.6%	62.7	0.2	26.7	0.8	C
119	SR-65 NB - Sunset Blvd Off to On-ramp	Basic	2,886	91	97.5%							62.7	0.2	25.0	0.8	C
120	SR-65 NB - Sunset Blvd EB On-ramp	Merge	2,887	91	97.5%	135	16	103.5%				62.3	0.3	25.5	0.9	C
121	SR-65 NB - Sunset Blvd to Whitney Ranch Pkwy	Weave	3,020	98	97.7%	396	16	98.9%	469	52	95.8%	62.2	0.3	25.0	0.7	C
124	SR-65 NB - Whitney Ranch Pkwy Off to On-ramp	Basic	2,940	84	98.0%							62.6	0.1	25.5	0.5	C
125	SR-65 NB - Whitney Ranch Pkwy EB On-ramp	Merge	2,941	85	98.0%	169	9	93.8%				62.3	0.2	26.0	0.5	C
126	SR-65 NB - Whitney Ranch Pkwy WB On-ramp	Merge	3,108	85	97.7%	267	15	102.7%				61.6	0.3	28.8	0.6	D
127	SR-65 NB - Whitney Ranch Pkwy to Twelve Bridges Dr	Basic	3,369	85	97.9%							62.2	0.1	29.1	0.5	D
128	SR-65 NB - Twelve Bridges Dr Off-ramp	Diverge	3,367	84	97.9%				719	54	104.2%	61.3	0.5	29.9	0.6	D
129	SR-65 NB - Twelve Bridges Dr Off to On-ramp	Basic	2,645	72	96.2%							62.9	0.2	23.3	0.5	C
130	SR-65 NB - Twelve Bridges Dr to Lincoln Blvd	Weave	2,640	78	96.0%	268	24	92.5%	984	52	96.4%	63.3	0.2	19.4	0.4	B
133	SR-65 NB - Lincoln Blvd to Ferrari Ranch Rd	Basic	1,922	67	95.1%							63.5	0.1	18.5	0.6	C
134	SR-65 NB - Ferrari Ranch Rd Off-ramp	Diverge	1,920	67	95.1%				1,331	64	95.1%	64.1	0.1	14.5	0.5	B
135	SR-65 NB - Ferrari Ranch Rd Off to On-ramp	Basic	588	41	94.8%							64.5	0.2	5.4	0.3	A
136	SR-65 NB - Ferrari Ranch Rd On-ramp	Merge	587	41	94.7%	83	5	92.0%				63.2	0.2	5.6	0.2	A
150	SR-65 SB - Ferrari Ranch Rd Off-ramp	Diverge	950	36	101.1%				144	16	96.3%	64.5	0.2	8.2	0.2	A
151	SR-65 SB - Ferrari Ranch Rd Off to On-ramp	Basic	806	35	102.1%							64.5	0.2	6.9	0.2	A
152	SR-65 SB - Ferrari Ranch Rd WB On-ramp	Merge	807	36	102.1%	475	17	101.1%				61.8	0.3	7.8	0.2	A
153	SR-65 SB - Ferrari Ranch Rd EB On-ramp	Merge	1,281	35	101.7%	326	16	93.0%				62.5	0.2	10.4	0.3	B
154	SR-65 SB - Ferrari Ranch Rd to Lane Drop	Basic	1,605	36	99.7%							64.1	0.2	13.6	0.3	B
155	SR-65 SB - Lane Drop to Lincoln Blvd	Basic	1,605	38	99.7%							64.2	0.2	13.6	0.3	B
156	SR-65 SB - Lincoln Blvd to Twelve Bridges Dr	Weave	1,604	46	99.6%	700	43	98.6%	262	30	97.0%	62.5	0.3	14.4	0.3	B
159	SR-65 SB - Twelve Bridges Dr Off to On-ramp	Basic	2,043	61	99.7%							63.6	0.2	16.9	0.4	B
160	SR-65 SB - Twelve Bridges Dr On-ramp	Merge	2,043	61	99.7%	391	17	97.7%				61.9	0.5	18.7	0.5	B
161	SR-65 SB - Twelve Bridges Dr to Placer Pkwy	Basic	2,434	63	99.3%							63.3	0.2	20.0	0.6	C
162	SR-65 SB - Placer Pkwy Off-ramp	Diverge	2,432	66	99.2%				446	37	99.1%	63.4	0.2	18.9	0.5	B
163	SR-65 SB - Placer Pkwy Off to On-ramp	Basic	1,992	62	99.6%							63.6	0.2	16.5	0.6	B
164	SR-65 SB - Placer Pkwy WB On-ramp	Merge	1,991	62	99.6%	301	27	96.9%				62.3	0.7	18.2	0.7	B
165	SR-65 SB - Placer Pkwy to Sunset Blvd	Weave	2,293	67	99.2%	284	27	94.6%	368	34	99.5%	62.8	0.2	17.9	0.4	B
168	SR-65 SB - Sunset Blvd Off to On-ramp	Basic	2,207	77	98.5%							63.3	0.1	18.2	0.6	C
169	SR-65 SB - Sunset Blvd WB On-ramp	Merge	2,206	78	98.5%	605	14	102.5%				61.3	0.3	21.1	0.5	C
170	SR-65 SB - Sunset Blvd EB On-ramp	Merge	2,808	79	99.2%	533	28	100.5%				60.9	0.7	28.3	0.7	D
171	SR-65 SB - Sunset Blvd to Blue Oaks Blvd	Basic	3,340	83	99.4%							62.0	0.4	28.6	0.7	D
172	SR-65 SB - Blue Oaks Blvd Off-ramp	Diverge	3,337	83	99.3%				620	49	93.9%	62.6	0.2	27.9	0.5	C
173	SR-65 SB - Blue Oaks Blvd Off to On-ramp	Basic	2,715	92	100.6%							63.2	0.2	22.6	0.8	C
174	SR-65 SB - Blue Oaks Blvd WB On-ramp	Merge	2,714	89	100.5%	343	1	90.4%				61.2	0.3	24.1	0.8	C
175	SR-65 SB - Blue Oaks Blvd to Pleasant Grove Blvd	Weave	3,058	87	99.3%	1,180	77	96.7%	524	46	91.9%	59.7	0.7	26.3	0.8	C
178	SR-65 SB - Pleasant Grove Blvd Off to On-ramp	Basic	3,718	116	99.7%							62.0	0.5	31.2	0.9	D
179	SR-65 SB - Pleasant Grove Blvd WB On-ramp	Merge	3,717	115	99.7%	525	36	101.0%				61.8	0.3	26.7	0.6	C
180	SR-65 SB - Pleasant Grove Blvd EB On-ramp	Merge	4,240	122	99.8%	799	44	97.4%				60.9	0.7	25.9	0.8	C
181	SR-65 SB - Pleasant Grove Blvd to Galleria Blvd	Basic	5,034	125	99.3%							63.9	0.2	26.8	0.7	D
182	SR-65 SB - Galleria Blvd Off-ramp	Diverge	5,034	124	99.3%				945	63	94.5%	64.9	0.1	27.6	0.6	C
183	SR-65 SB - Galleria Blvd Off to On-ramp	Basic	4,051	111	99.5%							62.4	0.3	24.7	0.5	C
185	SR-65 SB - Galleria Blvd On-ramp	Merge	4,049	108	99.5%	1,003	65	94.6%				55.9	3.7	33.2	2.4	D
186	SR-65 SB - I-80 Off-ramp	Diverge	5,050	131	98.4%				3,206	110	167.0%	60.8	0.8	28.3	0.6	D
187	SR-65 SB - EB I-80 Connector (2 lanes)	Basic	1,850	71	96.3%							55.6	2.6	34.9	2.3	D
188	SR-65 SB - EB I-80 Connector (1 lane)	Basic	1,847	76	96.2%							60.1	0.5	32.7	1.0	D
189	SR-65 SB - WB I-80 Connector	Basic	3,210	110	100.0%							52.6	0.3	31.6	0.8	D

Notes: Average density reported for the analysis area only: for example, within the ramp influence area and not including the HOV lane.
Mainline volume is the upstream served volume for all lanes.

VISSIM Post-Processor
Average Results from 10 Runs
Intersection Volume and Delay

SR 65 Widening
Construction Year - No Build
AM Peak Hour

	Intersection	Control	Volume (vph)		Percent Served	Delay (sec/veh)		Level of Service
			Demand	Served		Average	Std. Dev.	
1	Lincoln Blvd/Sterling Parkway	Signal	1,890	2,073	109.7%	9.8	0.9	A
2	SR-65 SB Ramps/Twelve Bridges Dr	Signal	1,150	1,285	111.7%	8.6	0.6	A
3	SR-65 NB Ramps/Twelve Bridges Dr	Signal	1,285	1,372	106.7%	8.8	1.0	A
4	SR-65 SB Ramps/Sunset Blvd	Signal	2,300	2,448	106.4%	10.4	0.4	B
5	SR-65 NB Ramps/Sunset Blvd	Signal	2,585	2,790	107.9%	14.7	2.9	B
6	SR-65 SB Ramps-Washington Blvd/Blue Oaks Blvd	Signal	4,580	4,733	103.3%	51.8	17.7	D
7	SR-65 NB Ramps/Blue Oaks Blvd	Signal	3,040	3,270	107.6%	12.7	3.3	B
8	SR-65 SB Ramps/Pleasant Grove Blvd	Signal	3,900	4,022	103.1%	5.9	0.4	A
9	SR-65 NB Ramps/Pleasant Grove Blvd	Signal	2,985	3,028	101.4%	11.1	0.5	B
10	Stanford Ranch Rd/Five Star Blvd	Signal	2,885	2,990	103.6%	28.9	1.5	C
11	SR-65 NB Ramps/Stanford Ranch Rd	Signal	3,435	3,601	104.8%	17.5	16.8	B
12	SR-65 SB Ramps/Galleria Blvd	Signal	3,675	3,781	102.9%	17.2	1.2	B
13	Galleria Blvd/Antelope Creek Dr	Signal	2,855	2,925	102.5%	13.9	2.1	B
14	Galleria Blvd/Roseville Pkwy	Signal	5,195	5,528	106.4%	37.1	0.7	D
15	Creekside Ridge Dr/Roseville Pkwy	Signal	3,550	3,736	105.2%	10.6	7.5	B
16	Taylor Rd/East Roseville Pkwy	Signal	4,530	4,773	105.4%	132.5	18.6	F
17	North Sunrise Ave/East Roseville Pkwy	Signal	4,325	4,588	106.1%	23.3	1.0	C
18	Wills Rd/Atlantic St	Signal	1,955	2,170	111.0%	18.9	2.6	B
19	I-80 WB Ramps/Atlantic St	Signal	3,395	3,628	106.9%	11.0	1.0	B
20	Taylor Rd-I-80 EB Ramps/Eureka Rd	Signal	4,385	4,628	105.5%	22.4	1.4	C
21	North Sunrise Ave/Eureka Rd	Signal	3,995	4,203	105.2%	26.0	2.3	C
22	Harding Blvd/Wills Rd	Signal	2,125	2,262	106.4%	14.3	1.6	B
23	Harding Blvd/Douglas Blvd	Signal	2,735	2,956	108.1%	36.2	18.8	D
24	I-80 WB Ramps/Douglas Blvd	Signal	3,680	3,953	107.4%	19.7	3.6	B

Network Summary	
Total Demand Volume (veh/hr)	76,435
Total Volume Served (veh/hr)	80,742
Percent Served	105.6%

- Notes: 1. Volume is measured for the entire peak hour.
2. Delay is measured for the peak 15 minutes in the peak hour.

VISSIM Post-Processor
Average Results from 10 Runs
Intersection Volume and Delay

SR 65 Widening
Construction Year - No Build
AM Peak Hour

	Intersection	Control	Volume (vph)		Percent Served	Delay (sec/veh)		Level of Service
			Demand	Served		Average	Std. Dev.	
25	I-80 EB Ramps/Douglas Blvd	Signal	4,060	4,395	108.3%	11.5	8.6	B
26	North Sunrise Ave/Douglas Blvd	Signal	4,380	4,662	106.4%	28.3	1.3	C
27	Pacific St/Woodside Dr	Signal	1,700	1,869	109.9%	8.7	0.9	A
28	Pacific St/Sunset Blvd	Signal	2,600	2,863	110.1%	26.8	1.0	C
29	Granite Dr/Rocklin Rd	Signal	2,401	2,497	104.0%	19.3	1.9	B
30	I-80 WB Ramps/Rocklin Rd	Signal	2,655	2,771	104.4%	20.5	5.5	C
31	I-80 EB Ramps/Rocklin Rd	Signal	2,745	2,900	105.6%	36.5	21.4	D
32	Aguilar Rd/Rocklin Rd	Signal	1,930	2,050	106.2%	23.2	34.0	C
33	Lincoln Blvd/SR-65 NB Off-Ramp	Signal	1,835	2,011	109.6%	6.2	0.7	A
34	Lincoln Blvd/SR-65 SB On-Ramp	Signal	1,270	1,366	107.5%	20.4	2.4	C
35	SR-65 SB Ramps/Placer Pkwy	Signal	1,690	1,734	102.6%	8.8	0.6	A
36	SR-65 NB Ramps/Whitney Ranch Pkwy	Signal	1,625	1,729	106.4%	10.8	6.8	B
40	Galleria Blvd/Berry St	Signal	1,965	2,076	105.7%	10.6	2.1	B

Network Summary	
Total Demand Volume (veh/hr)	30,856
Total Volume Served (veh/hr)	32,922
Percent Served	106.7%

- Notes: 1. Volume is measured for the entire peak hour.
2. Delay is measured for the peak 15 minutes in the peak hour.

VISSIM Post-Processor
Average Results from 10 Runs
Intersection Volume and Delay

SR 65 Widening
Construction Year - No Build Alternative
PM Peak Hour

	Intersection	Control	Volume (vph)		Percent Served	Delay (sec/veh)		Level of Service
			Demand	Served		Average	Std. Dev.	
1	Lincoln Blvd/Sterling Parkway	Signal	2,455	2,413	98.3%	8.4	0.7	A
2	SR-65 SB Ramps/Twelve Bridges Dr	Signal	985	962	97.6%	6.8	0.9	A
3	SR-65 NB Ramps/Twelve Bridges Dr	Signal	1,430	1,433	100.2%	8.6	0.7	A
4	SR-65 SB Ramps/Sunset Blvd	Signal	2,725	2,832	103.9%	12.2	6.3	B
5	SR-65 NB Ramps/Sunset Blvd	Signal	2,725	2,832	103.9%	16.8	9.4	B
6	SR-65 SB Ramps-Washington Blvd/Blue Oaks Blvd	Signal	5,485	5,359	97.7%	125.7	14.8	F
7	SR-65 NB Ramps/Blue Oaks Blvd	Signal	3,725	3,791	101.8%	70.1	21.0	E
8	SR-65 SB Ramps/Pleasant Grove Blvd	Signal	5,230	5,189	99.2%	6.6	0.7	A
9	SR-65 NB Ramps/Pleasant Grove Blvd	Signal	4,500	4,493	99.8%	11.6	3.0	B
10	Stanford Ranch Rd/Five Star Blvd	Signal	4,575	4,556	99.6%	48.3	2.8	D
11	SR-65 NB Ramps/Stanford Ranch Rd	Signal	5,410	5,375	99.4%	12.3	1.0	B
12	SR-65 SB Ramps/Galleria Blvd	Signal	5,465	5,396	98.7%	15.9	0.9	B
13	Galleria Blvd/Antelope Creek Dr	Signal	4,545	4,308	94.8%	24.4	1.9	C
14	Galleria Blvd/Roseville Pkwy	Signal	7,650	7,502	98.1%	57.7	11.4	E
15	Creekside Ridge Dr/Roseville Pkwy	Signal	4,675	4,583	98.0%	25.7	5.1	C
16	Taylor Rd/East Roseville Pkwy	Signal	5,880	5,852	99.5%	42.4	3.2	D
17	North Sunrise Ave/East Roseville Pkwy	Signal	5,465	5,518	101.0%	30.0	2.4	C
18	Wills Rd/Atlantic St	Signal	2,945	3,047	103.5%	22.1	2.3	C
19	I-80 WB Ramps/Atlantic St	Signal	4,435	4,545	102.5%	11.8	1.2	B
20	Taylor Rd-I-80 EB Ramps/Eureka Rd	Signal	5,725	5,841	102.0%	40.9	6.5	D
21	North Sunrise Ave/Eureka Rd	Signal	5,595	5,832	104.2%	62.0	19.8	E
22	Harding Blvd/Wills Rd	Signal	2,990	3,069	102.6%	19.2	2.3	B
23	Harding Blvd/Douglas Blvd	Signal	3,785	3,616	95.5%	91.9	27.6	F
24	I-80 WB Ramps/Douglas Blvd	Signal	4,510	4,481	99.4%	30.8	5.1	C

Network Summary	
Total Demand Volume (veh/hr)	102,910
Total Volume Served (veh/hr)	102,822
Percent Served	99.9%

- Notes: 1. Volume is measured for the entire peak hour.
2. Delay is measured for the peak 15 minutes in the peak hour.

VISSIM Post-Processor
Average Results from 10 Runs
Intersection Volume and Delay

SR 65 Widening
Construction Year - No Build Alternative
PM Peak Hour

	Intersection	Control	Volume (vph)		Percent Served	Delay (sec/veh)		Level of Service
			Demand	Served		Average	Std. Dev.	
25	I-80 EB Ramps/Douglas Blvd	Signal	5,245	5,188	98.9%	28.6	9.2	C
26	North Sunrise Ave/Douglas Blvd	Signal	5,870	5,874	100.1%	39.0	1.6	D
27	Pacific St/Woodside Dr	Signal	2,250	2,052	91.2%	8.5	1.2	A
28	Pacific St/Sunset Blvd	Signal	3,580	3,113	87.0%	85.7	1.6	F
29	Granite Dr/Rocklin Rd	Signal	3,740	3,655	97.7%	127.0	4.9	F
30	I-80 WB Ramps/Rocklin Rd	Signal	3,770	3,766	99.9%	38.2	13.5	D
31	I-80 EB Ramps/Rocklin Rd	Signal	3,545	3,576	100.9%	32.7	7.2	C
32	Aguilar Rd/Rocklin Rd	Signal	2,415	2,453	101.6%	30.2	8.8	C
33	Lincoln Blvd/SR-65 NB Off-Ramp	Signal	2,315	2,271	98.1%	7.8	0.8	A
34	Lincoln Blvd/SR-65 SB On-Ramp	Signal	1,300	1,292	99.4%	21.4	3.0	C
35	SR-65 SB Ramps/Placer Pkwy	Signal	1,950	1,958	100.4%	8.5	0.6	A
36	SR-65 NB Ramps/Whitney Ranch Pkwy	Signal	1,945	1,953	100.4%	22.5	17.4	C
40	Galleria Blvd/Berry St	Signal	2,855	2,890	101.2%	9.5	2.0	A

Network Summary	
Total Demand Volume (veh/hr)	40,780
Total Volume Served (veh/hr)	40,042
Percent Served	98.2%

- Notes: 1. Volume is measured for the entire peak hour.
2. Delay is measured for the peak 15 minutes in the peak hour.

SR 65 Capacity and Operational Improvements

OD Adjustment Methodology Memorandum

MEMORANDUM

Date: May 27, 2014

To: Matt Brogan, Mark Thomas

From: Ronald T. Milam, Fehr & Peers

Subject: SR 65 Capacity and Operational Improvements Project – OD Adjustment Methodology

The purpose of this memorandum is to describe the methodology proposed to modify the preliminary traffic volume forecasts for the SR 65 Capacity and Operational Improvements Project (SR 65 COI). Preliminary forecasts were developed as part of the screening assessment for this project based on travel forecast modeling completed for the I-80/SR 65 Interchange project. The preliminary forecasts will be refined for the final alternatives that are carried forward from the screening assessment into final traffic operations analysis. Refinements are desired to better capture recent land use planning decisions that have occurred in the City of Lincoln.

BACKGROUND

During the development of traffic forecasts for the I-80/SR 65 Interchange project, future development in the City of Lincoln was concentrated in the center and eastern portions of the City. Recent development plans show a shift in growth towards the western portion of the City along the new Lincoln Bypass. This change does not affect the I-80/SR 65 project because of the long distance between the development area and the interchange, but it does affect traffic volumes at the northern edge of the study area for the SR 65 COI project.

To confirm the level of change and how it could affect the SR 65 COI forecasts, we reviewed new land use and traffic volume forecasts being developed for the South Placer Regional Transportation Authority (SPRTA) fee study. While the overall land use growth projections were similar to those for the SR 65 COI project, the SPRTA growth allocations were higher near the Lincoln Bypass. A comparison of peak hour traffic volume assignments between the two projects revealed that the SPRTA fee program forecasts had more trips accessing SR 65 at interchanges north of Lincoln Boulevard. This results in more traffic on the SR 65 mainline entering the SR 65 COI study area instead of accessing the corridor at the Lincoln Boulevard interchange.

PROPOSED ADJUSTMENTS

In response to the background findings above, Fehr & Peers developed an origin-destination (OD) adjustment methodology to refine the peak hour forecasts that will be used in the final traffic operations analysis. The methodology starts with identifying the traffic volume distribution on SR 65 versus Lincoln Boulevard at the screenline intersect locations shown on the map below.

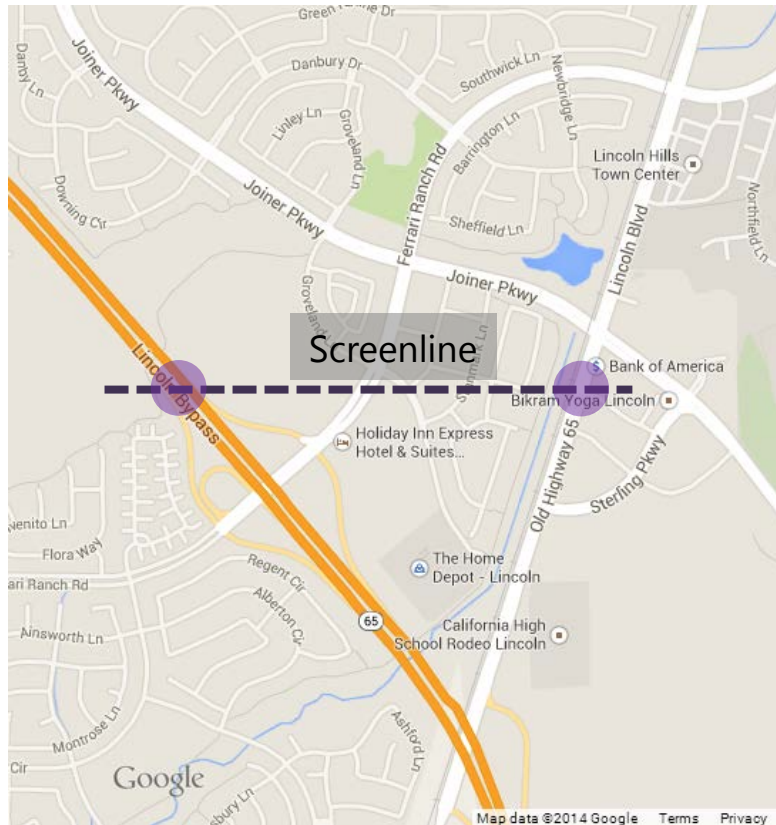

AM and PM peak hour traffic volume forecasts for design year (2040) conditions at the screenline locations (denoted by in purple circles in the above map) were compared from the SPRTA impact fee study and SR 65 COI project. . The results are shown in Table 1.

TABLE 1 COMPARISON OF DESIGN YEAR (2040) PEAK HOUR TRAFFIC VOLUME FORECASTS				
Travel Direction	AM		PM	
	SPRTA Fee Study	SR 65 COI	SPRTA Fee Study	SR 65 COI
Northbound				
• SR 65 (n/o Ferrari Ranch Rd)	58%	45%	72%	39%
• Lincoln Blvd (n/o Sterling Pkwy)	42%	55%	28%	61%
Total	100%	100%	100%	100%
Southbound				
• SR 65 (n/o Ferrari Ranch Rd)	63%	42%	61%	40%
• Lincoln Blvd (n/o Sterling Pkwy)	37%	58%	39%	60%
Total	100%	100%	100%	100%

In general, the traffic patterns are almost reversed between the two models due to the difference in land use growth allocations. For the SR 65 COI, these differences only affect the start or end of trips at the northern end of the study area. Therefore, the proposed adjustment is to modify the origin-destination (OD) trip tables in the SR 65 COI models such that the final traffic volume distribution matches the SPRTA impact fee study distribution shown in Table 1. The adjustment process may result in a volume that is lower than the traffic counts collected in 2013. In this unlikely event, the existing count volume will be used as the forecasted value.

This adjustment will not change the OD trips but will influence the paths used by the trips. For example, a portion of the northbound SR 65 PM peak hour trips that exit at Lincoln Boulevard will be adjusted such that their final destination is a zone connecting to the SR 65 mainline north of Ferrari Ranch Road. This adjustment has the effect of keeping these trips on the mainline through the Lincoln Boulevard and Ferrari Ranch Road interchanges instead of exiting at the Lincoln Boulevard northbound off-ramp. A similar adjustment will be applied to the southbound direction. The adjustments will be applied to design year volumes and, if necessary, to the construction year volumes. Construction year volume adjustments would be based on a linear interpolation between existing traffic volumes and the final adjusted design year traffic volumes.

SR 65 Capacity and Operational Improvements
Alternatives Screening Assessment Memorandum

MEMORANDUM

Date: May 28, 2014

To: Matt Brogan, Mark Thomas

From: Allen Wang, David Stanek, & Ronald T. Milam, Fehr & Peers

Subject: SR 65 Capacity and Operational Improvements Project – Alternatives Screening Assessment

This memorandum describes the results of the SR 65 Capacity and Operational Improvements (COI) project alternatives screening assessment. This assessment was performed using the VISUM meso-scale models originally developed for the I-80/SR 65 Interchange Improvements project and recently refined for the SR 65 COI project.

The key refinement was to include traffic counts collected at the Twelve Bridges Drive, Lincoln Boulevard, and Ferrari Ranch Road interchanges in Lincoln. Existing conditions for the I-80/SR 65 project was prior to the opening of the Lincoln Bypass. Compared to the I-80/SR 65 traffic forecasts, the traffic counts showed higher traffic volumes on the ramps to and from the north at Twelve Bridges Drive and Ferrari Ranch Road. As a result, the design year traffic forecasts were adjusted upward to account for the higher observed traffic volumes. Based on recent discussions with the City of Lincoln, the traffic forecasts will be adjusted further to account for a shift in planned development from northeast Lincoln to the west along the bypass. This adjustment process will be documented in a separate memorandum.

The following five alternatives were initially considered for the screening assessment.

- No Build
- GP - add a general purpose (GP) lane in each direction
- HOV - add a high-occupancy vehicle (HOV) lane in each direction
- Hybrid - add an HOV lane in the south that transitions to a GP lane north of Blue Oaks Boulevard
- Constrained - widening with fewer mainline or auxiliary lanes to minimize environmental or right-of-way impacts

A review of the proposed cross section and the existing right of way limits showed that the proposed improvements for the build alternatives are likely to be within the existing right of way. Additionally, no

significant environmental constraints are anticipated within the existing right of way. Therefore, the Constrained alternative was eliminated from further consideration.

The alternatives assessment is based on 2040 design year conditions. Each of the four remaining alternatives is graphically represented in Figures 1 through 4. The diagrams show the mainline and auxiliary lanes added by the alternative and those assumed to be constructed by separate projects. These figures also show the AM and PM peak hour design year traffic volumes for the mainline and each ramp. The total HOV volume – in all lanes – is shown in the figures. Table 1 below reports the predicted volume in the HOV lane between interchanges (does not include entering or exiting HOV traffic).

TABLE 1: HOV LANE VOLUME				
Location	No Build	GP	HOV	Hybrid
Northbound				
I-80 to Stanford Ranch Rd	500 (980)	730 (1,500)	750 (1,540)	780 (1,570)
Stanford Ranch Rd to Pleasant Grove Blvd	-	-	680 (1,520)	790 (1,710)
Pleasant Grove Blvd to Blue Oaks Blvd	-	-	440 (1,150)	510 (1,310)
Blue Oaks Blvd to Sunset Blvd	-	-	350 (980)	-
Southbound				
Sunset Blvd to Blue Oaks Blvd	-	-	890 (1,010)	-
Blue Oaks Blvd to Pleasant Grove Blvd	-	-	1,130 (1,140)	1,330 (1,330)
Pleasant Grove Blvd to Galleria Blvd	-	-	1,140 (1,060)	1,250 (1,120)
Galleria Blvd to I-80	420 (300)	720 (530)	750 (550)	790 (580)
Note: The AM and (PM) peak hour volumes are reported.				
Source: Fehr & Peers, 2014				

The build alternatives would increase the HOV volume in the HOV lane south of Galleria Boulevard/Stanford Ranch Road compared to the No Build alternative. The higher capacity in the build alternatives provide more opportunity for HOVs to utilize the direct HOV-only ramps that will be built at the I-80/SR 65 interchange.

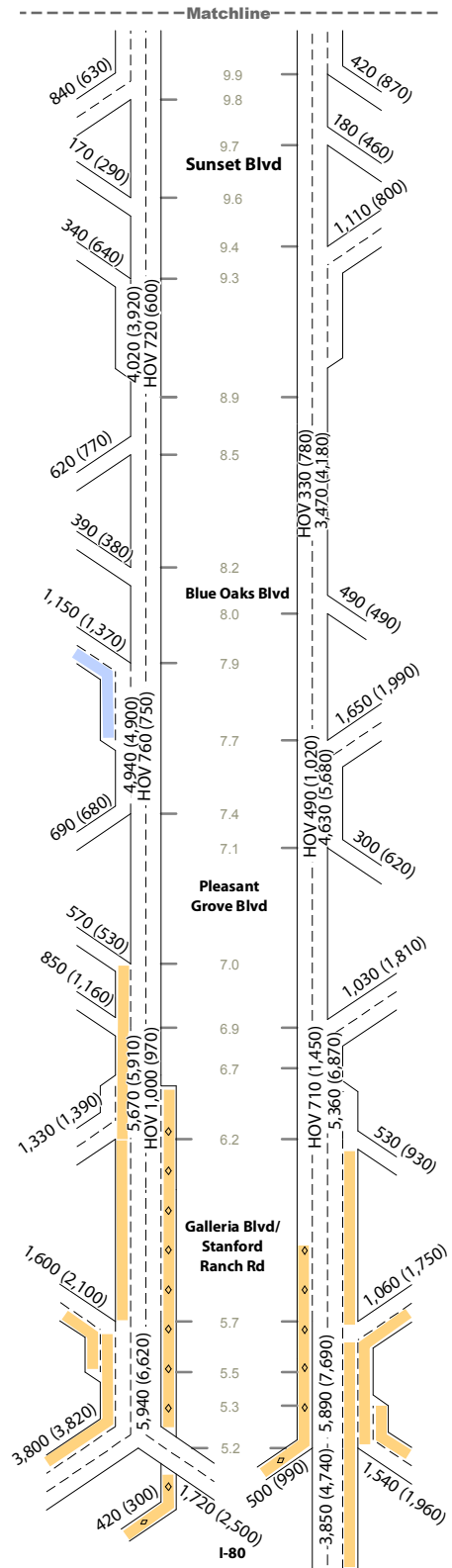
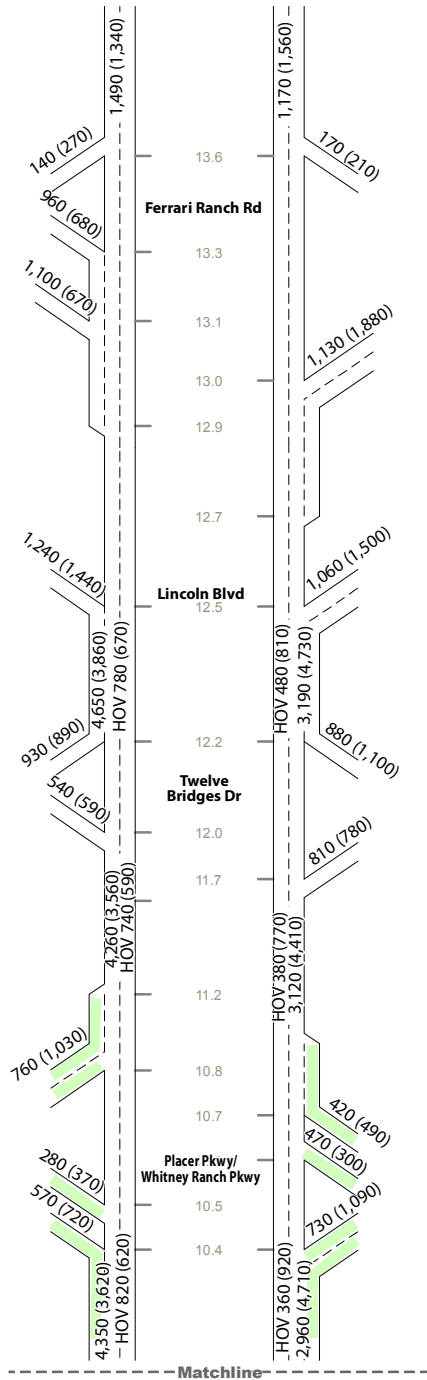

LEGEND

AM (PM) Peak Hour Total Volume
 HOV AM (PM) Peak Hour HOV Volume
 10.1 Postmile

Separate Planned Projects

- I-80/SR 65 Interchange
- Blue Oaks Boulevard Widening
- Placer Parkway/Whitney Ranch Parkway Interchange

Figure 1

Design Year Peak Hour Traffic Volumes and Lane Configurations - No Build Alternative

DRAFT



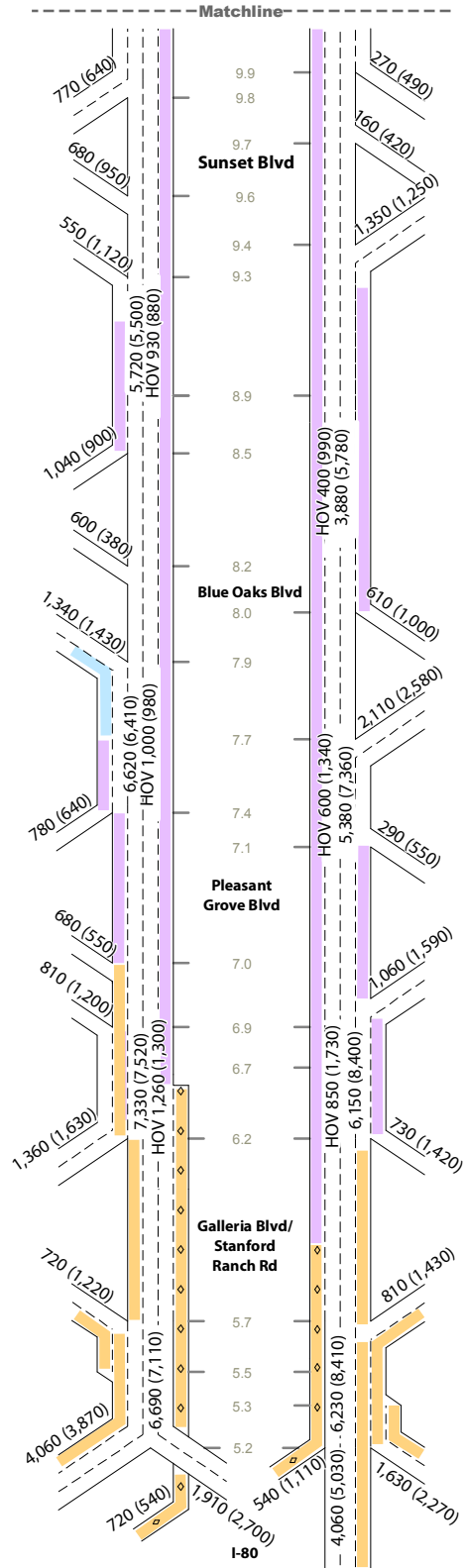
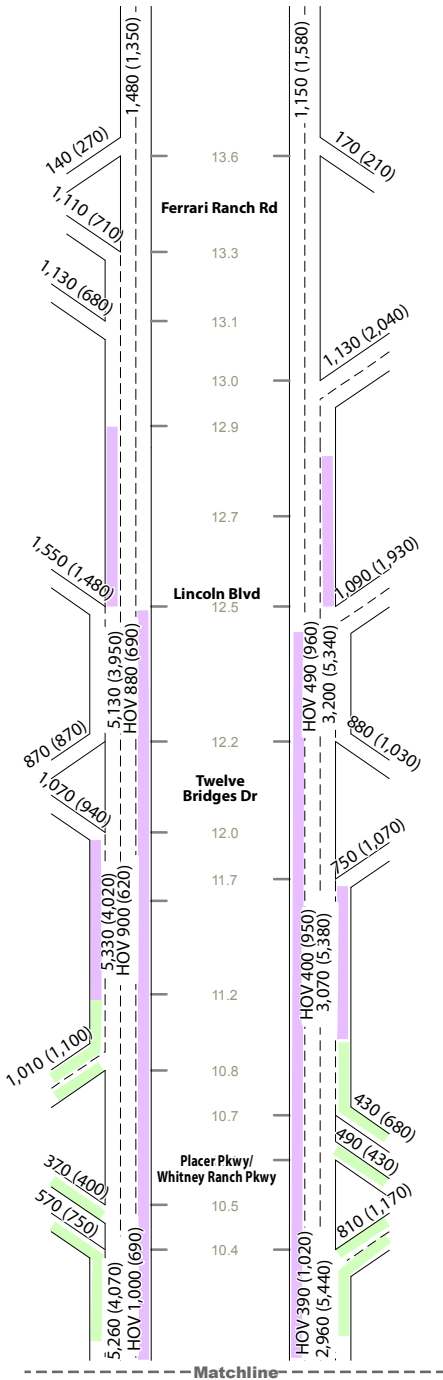

LEGEND

- AM (PM) Peak Hour Total Volume
- HOV AM (PM) Peak Hour HOV Volume
- 10.1 Postmile
- GP Alternative

Separate Planned Projects

- I-80/SR 65 Interchange
- Blue Oaks Boulevard Widening
- Placer Parkway/Whitney Ranch Parkway Interchange

Figure 2

Design Year Peak Hour Traffic Volumes and Lane Configurations - GP Alternative

DRAFT



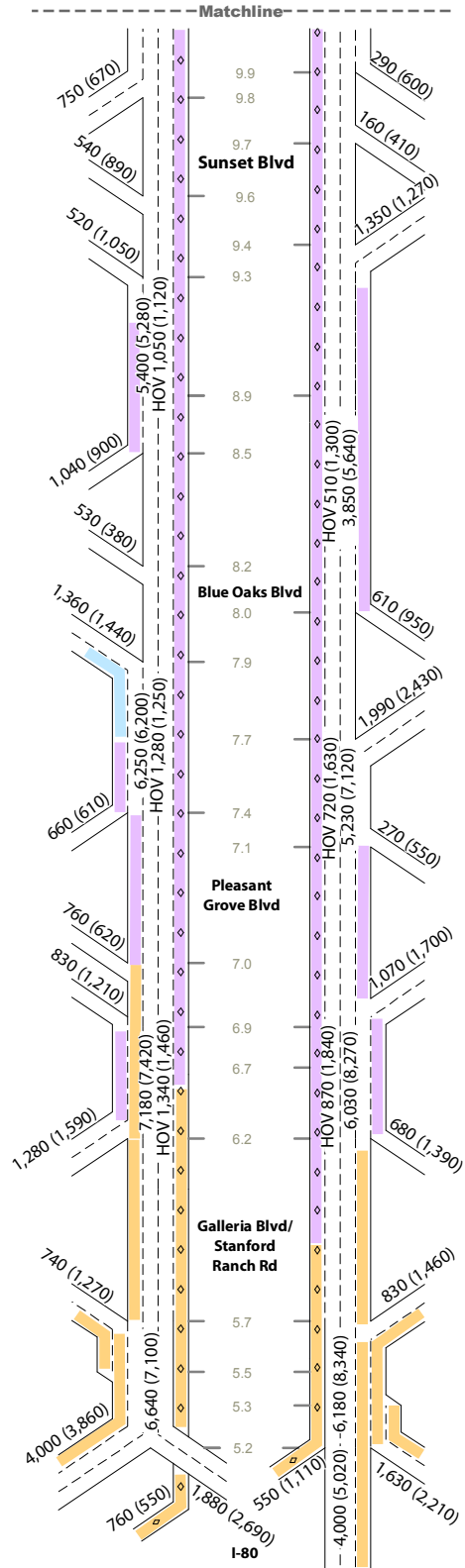
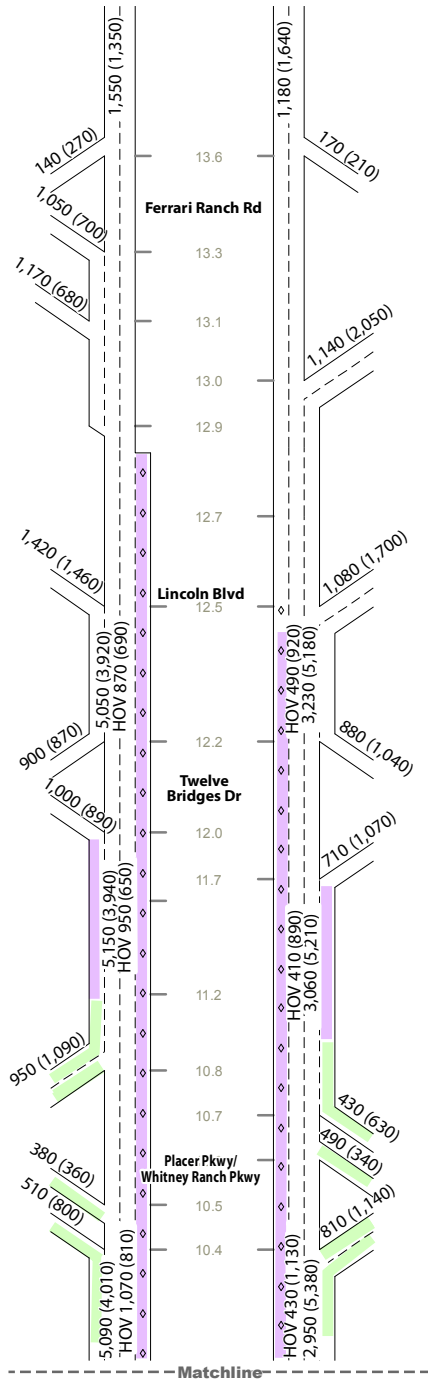

LEGEND

- AM (PM) Peak Hour Total Volume
- HOV AM (PM) Peak Hour HOV Volume
- 10.1 Postmile
- HOV Alternative
- Separate Planned Projects**
- I-80/SR 65 Interchange
- Blue Oaks Boulevard Widening
- Placer Parkway/Whitney Ranch Parkway Interchange

Figure 3

Design Year Peak Hour Traffic Volumes and Lane Configurations - HOV Alternative

DRAFT



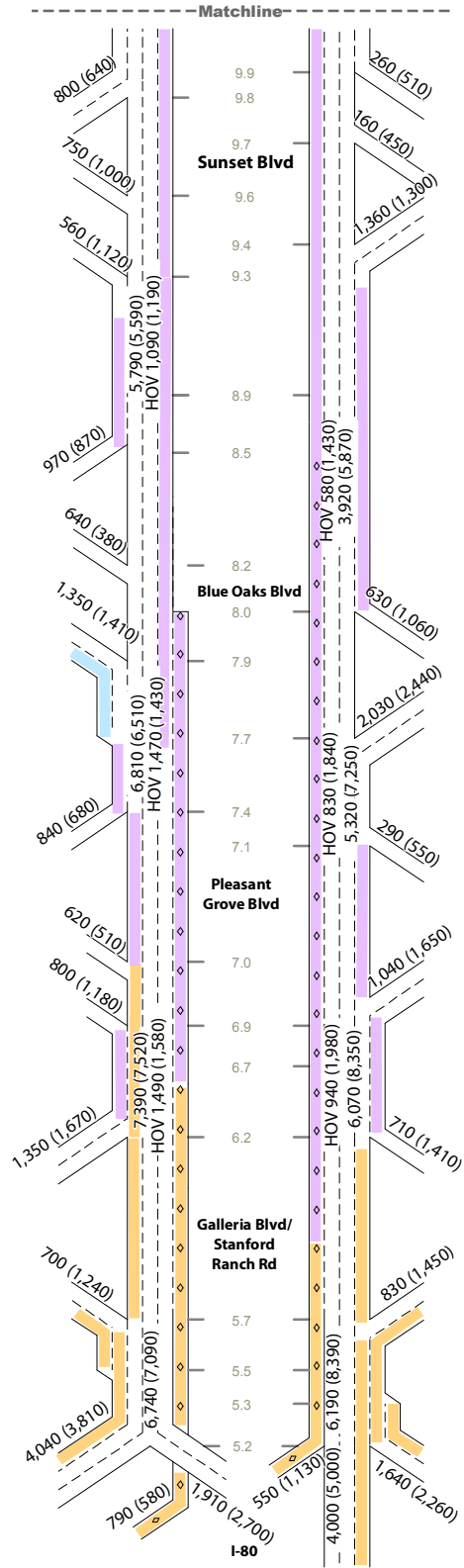
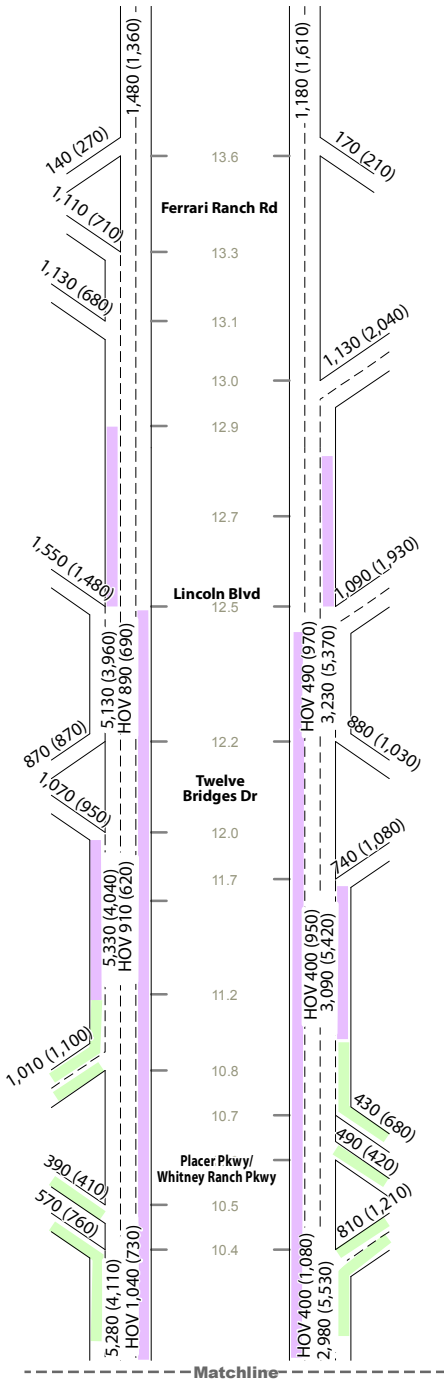

LEGEND

- AM (PM) Peak Hour Total Volume
- HOV AM (PM) Peak Hour HOV Volume
- 10.1 Postmile
- Hybrid Alternative
- Separate Planned Projects**
 - I-80/SR 65 Interchange
 - Blue Oaks Boulevard Widening
 - Placer Parkway/Whitney Ranch Parkway Interchange

Figure 4

Design Year Peak Hour Traffic Volumes and Lane Configurations - Hybrid Alternative

DRAFT



Of the build alternatives, the Hybrid alternative shows the highest peak hour HOV lane volume. While the GP lanes have higher overall capacity, the lack of an exclusive HOV lane along the corridor gives no travel time advantage to HOVs. So, they are not more likely to use the facility. Not surprisingly, the HOV alternative has a higher HOV lane volume due to the travel time advantage. The HOV lane volume is highest in the Hybrid alternative because (1) a travel time advantage exists and (2) additional GP lane capacity at bottlenecks allows for more demand volume to be served.

Based on these volumes, the following network-wide performance metrics were collected for the mesoscopic analysis area shown in Figure 5.

- Vehicle Miles Travelled (VMT)
- VMT by Speed Bin
- Vehicle Hours of Delay (VHD)
- Vehicle Hours Travelled (VHT)
- Freeway VHD
- Freeway Travel Time

Table 2 contains a summary of the alternatives assessment results with the exception of VMT by speed bin, which is contained in the detailed results summary in Attachment A.

The following discussion highlights the key findings of the assessment.

- VMT - In all three build scenarios, VMT is increasing above the projected no build level. This is to be expected due to induced travel resulting from improvements to the system. The **Hybrid** alternative had the smallest increase from the No Build alternative with an increase of 16,040 VMT. The HOV alternative produced the second lowest increase in VMT. *This suggests that HOV lane effectiveness may decline in the northern portions of the corridor where peak hour demand and capacity utilization are lower.*
- VHD - As expected, the greatest VHD were associated with the No Build alternative. The **GP** alternative had the lowest levels of delay followed by the Hybrid alternative.
- VHT - The **Hybrid** alternative had the greatest change in VHT from the No Build alternative, followed by the GP alternative. While GP had the lowest levels of delay, this scenario also produced the highest VMT, thereby inflating VHT.

LEGEND

- Mesoscopic (VISUM) Analysis Area
- Microscopic (VISSIM) Analysis Area
- County Boundary



NOT TO SCALE

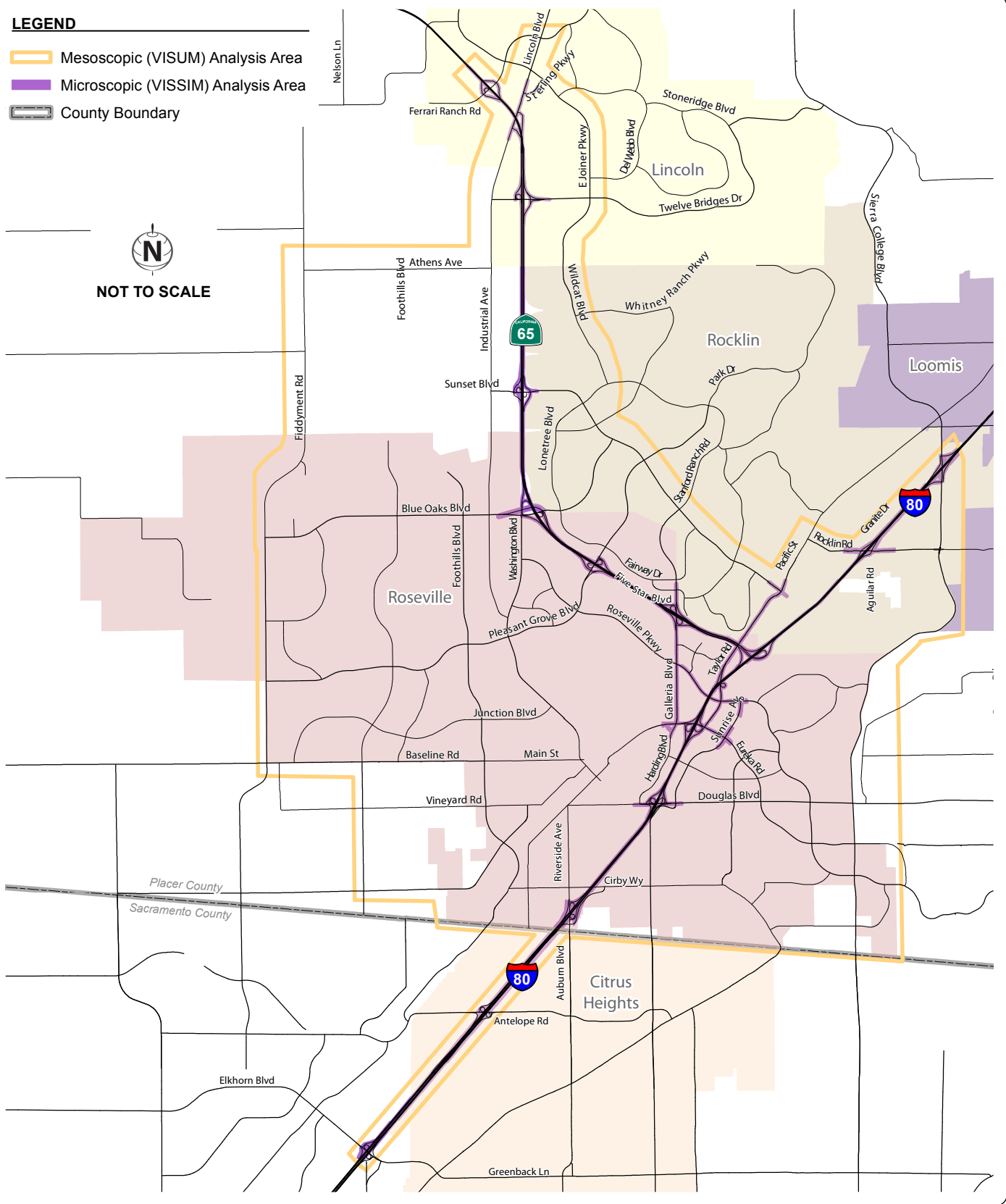

TABLE 2 ALTERNATIVES ASSESSMENT SUMMARY				
Metric (1)	No Build	GP	HOV	Hybrid
VMT	4,440,670	4,469,450	4,451,490	4,468,570
<i>Change from No Build</i>	--	+28,780	+10,820	+27,900
VHD (2)	71,440	64,690	65,190	64,890
<i>Change from No Build</i>	--	-6,750	-6,250	-6,550
VHT	164,260	157,010	157,260	157,230
<i>Change from No Build</i>	--	-7,250	-7,000	-7,030
Total Freeway VHD (3)	10,240	7,350	7,590	7,440
<i>Change from No Build</i>	--	-2,890	-2,650	-2,800
SR 65 Freeway VHD (3)	3,430	420	680	720
<i>Change from No Build</i>	--	-3,010	-2,750	-2,710
SOV Freeway Travel Time (4)				
Northbound - PM	19.7	12.4	14.4	12.9
Southbound - AM	17.7	10.9	12.9	10.9
HOV Freeway Travel Time (4)				
Northbound - PM	19.2	11.6	10.3	10.9
Southbound - AM	17.0	10.6	9.5	10.5
<p>Notes: Bold indicates largest change or difference from No Build.</p> <p>(1) Results are based on the sum of the AM and PM peak periods values.</p> <p>(2) For VHD, delay is the additional travel time that occurs when traveling on all roadways less than the free-flow speed.</p> <p>(3) Freeway VHD is the additional travel time only on freeways when traveling less than 35 mph. Total Freeway VHD includes both I-80 and SR 65, while SR 65 Freeway VHD only includes the latter route.</p> <p>(4) Travel time in minutes is measured between I-80 and Ferrari Ranch Road. The free-flow travel time (at 65 mph) is 7.2 minutes.</p> <p>Source: Fehr & Peers, 2014</p>				

- Freeway VHD - Freeway VHD was measured for freeway mainline links as the delay relative to a speed of 35 mph. Reductions in Freeway VHD from the No Build alternative produced the same results as VHD; the lowest levels of delay are associated with the **GP** alternative followed by the Hybrid alternative. The majority of Freeway VHD occurs on I-80. The build alternatives would reduce Freeway VHD on SR 65 by at least 79 percent.
- Freeway Travel Time - With the lowest VHD and greatest throughput by speed, the **GP** alternative had the lowest single occupancy vehicle (SOV) peak hour travel times in the peak direction. The Hybrid alternative was a very close runner up in the southbound direction during the AM peak hour. HOV travel times were consistently the lowest for the HOV alternative.

In addition to the metrics summarized above, VMT by speed bin was estimated for purposes of emissions analysis. Morning and evening peak period VMT by speed bin shows more VMT in the high speed bins (i.e., greater than 50 miles per hour) in the **GP** alternative. This is expected since this scenario had the lowest level of delay. The Hybrid alternative had the second highest VMT in high speed bins. Speed is important because air pollution and greenhouse gas (GHG) emission rates are lowest in the 45-55 miles per hour range. The GP alternative had more VMT in this range and a quick assessment of GHG emissions revealed that this also resulted in the lowest levels of emissions among the build alternatives. All the build alternatives had higher levels of GHG emissions than the No Build alternative due to higher total VMT.

ATTACHMENT A

DETAILED ASSESSMENT RESULTS

SR-65 WIDENING ALTERNATIVES DESIGN YEAR MESO-SCALE VMT COMPARISON

Alternative	Vehicle Miles of Travel (millions)			% Change from No Build		
	AM	PM	AM & PM	AM	PM	AM & PM
1 - No Build	1.99	2.45	4.44	-	-	-
2 - Mixed Flow	2.00	2.47	4.47	0.63%	0.66%	0.65%
3 - HOV	2.00	2.46	4.45	0.27%	0.22%	0.24%
4 - Hybrid	2.00	2.47	4.47	0.60%	0.66%	0.63%

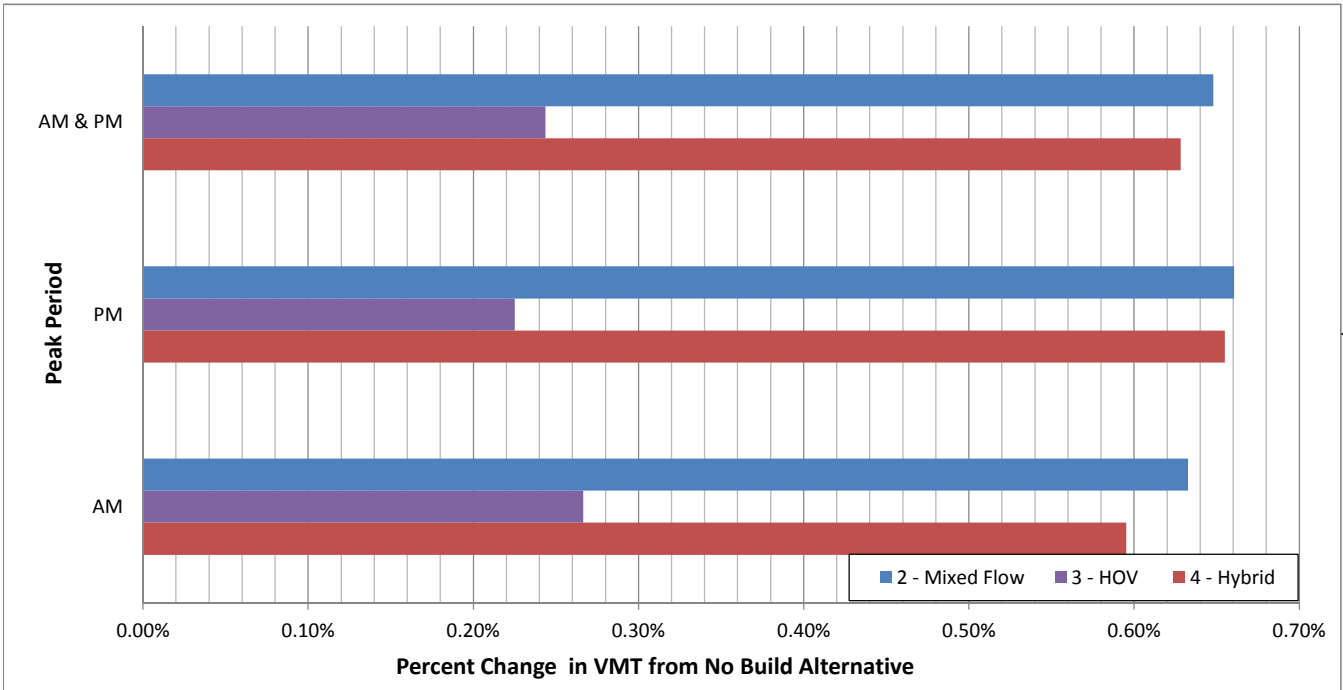
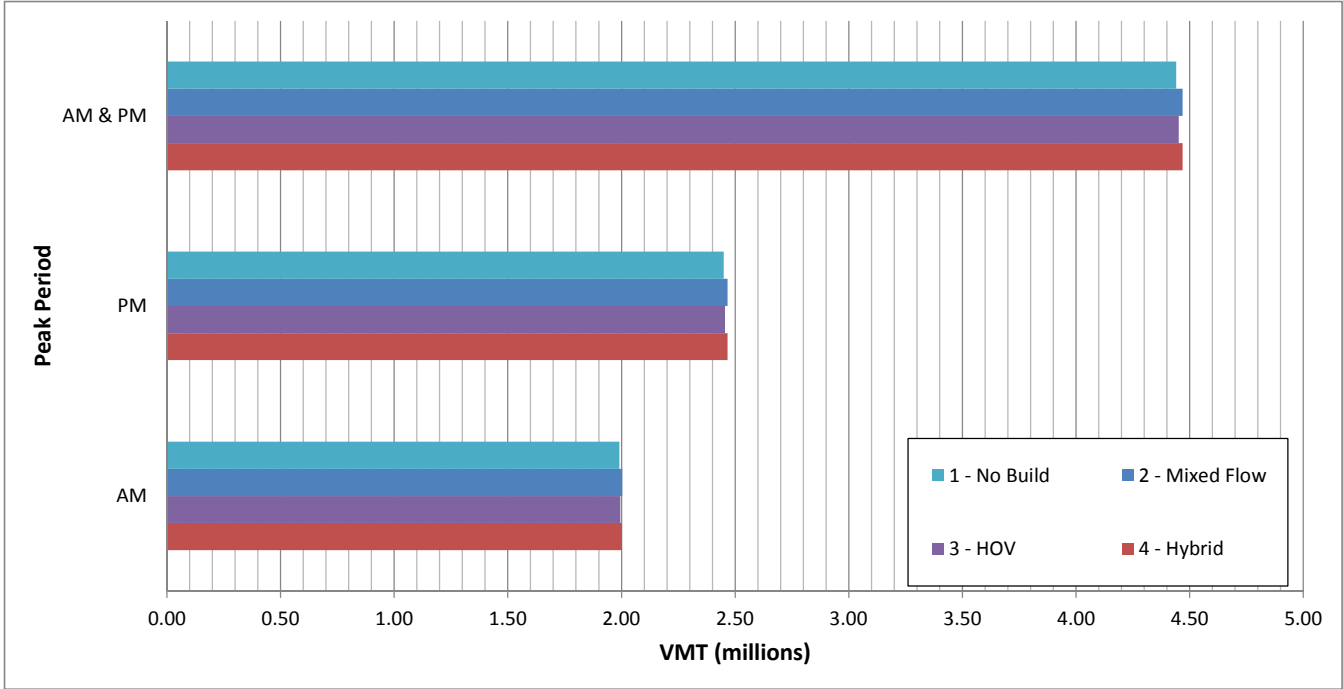

SR-65 WIDENING ALTERNATIVES DESIGN YEAR MESO-SCALE VHD COMPARISON

Alternative	Vehicle Hours of Delay (thousands)			% Change from No Build		
	AM	PM	AM & PM	AM	PM	AM & PM
1 - No Build	29.9	41.6	71.4	-	-	-
2 - Mixed Flow	27.7	37.0	64.7	-7.33%	-10.96%	-9.44%
3 - HOV	28.0	37.2	65.2	-6.33%	-10.48%	-8.74%
4 - Hybrid	27.8	37.1	64.9	-7.09%	-10.65%	-9.16%

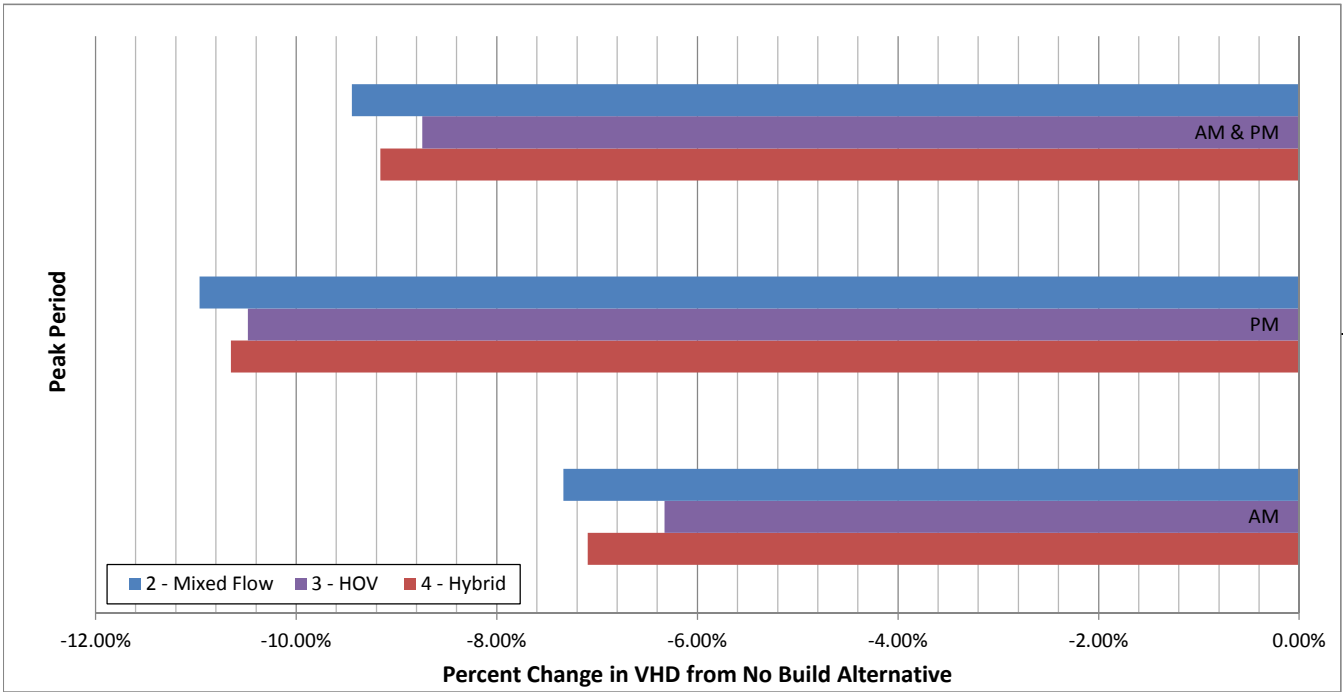
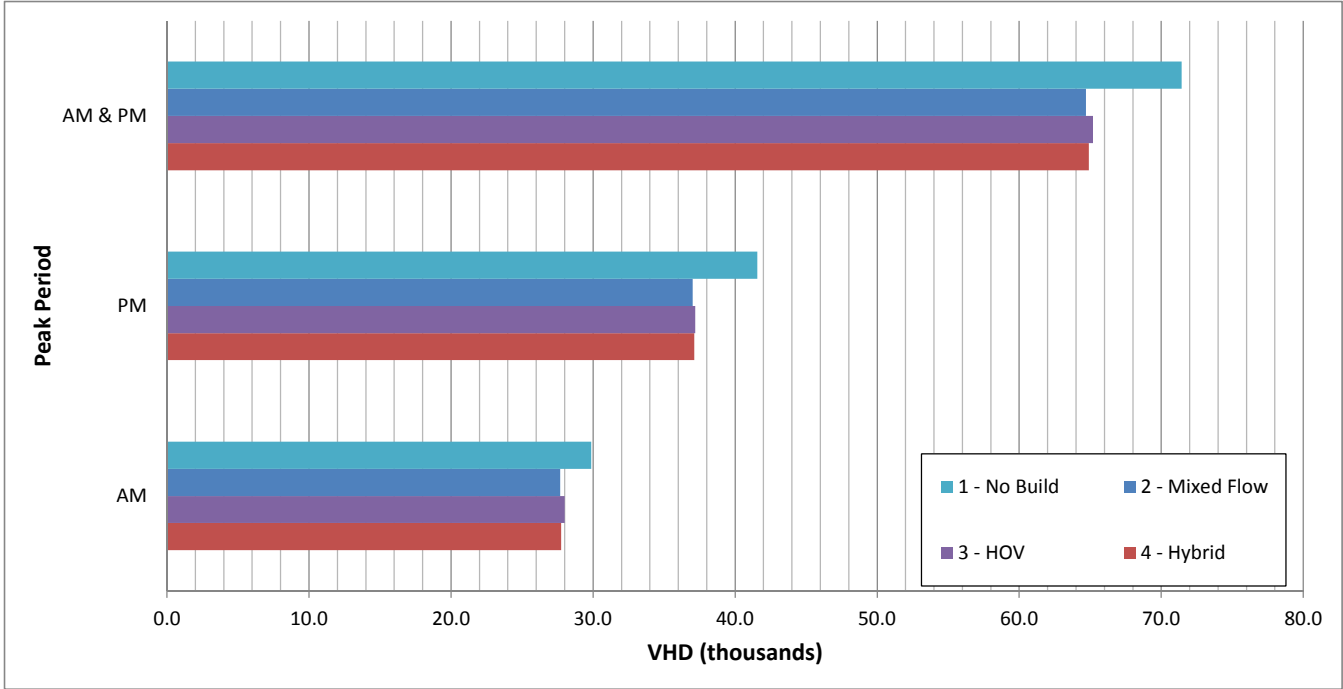

SR-65 WIDENING ALTERNATIVES DESIGN YEAR MESO-SCALE VHT COMPARISON

Alternative	Vehicle Hours of Travel (thousands)			% Change from No Build		
	AM	PM	AM & PM	AM	PM	AM & PM
1 - No Build	70.9	93.4	164.3	-	-	-
2 - Mixed Flow	68.5	88.5	157.0	-3.30%	-5.26%	-4.41%
3 - HOV	68.7	88.5	157.3	-3.02%	-5.20%	-4.26%
4 - Hybrid	68.6	88.6	157.2	-3.21%	-5.09%	-4.28%

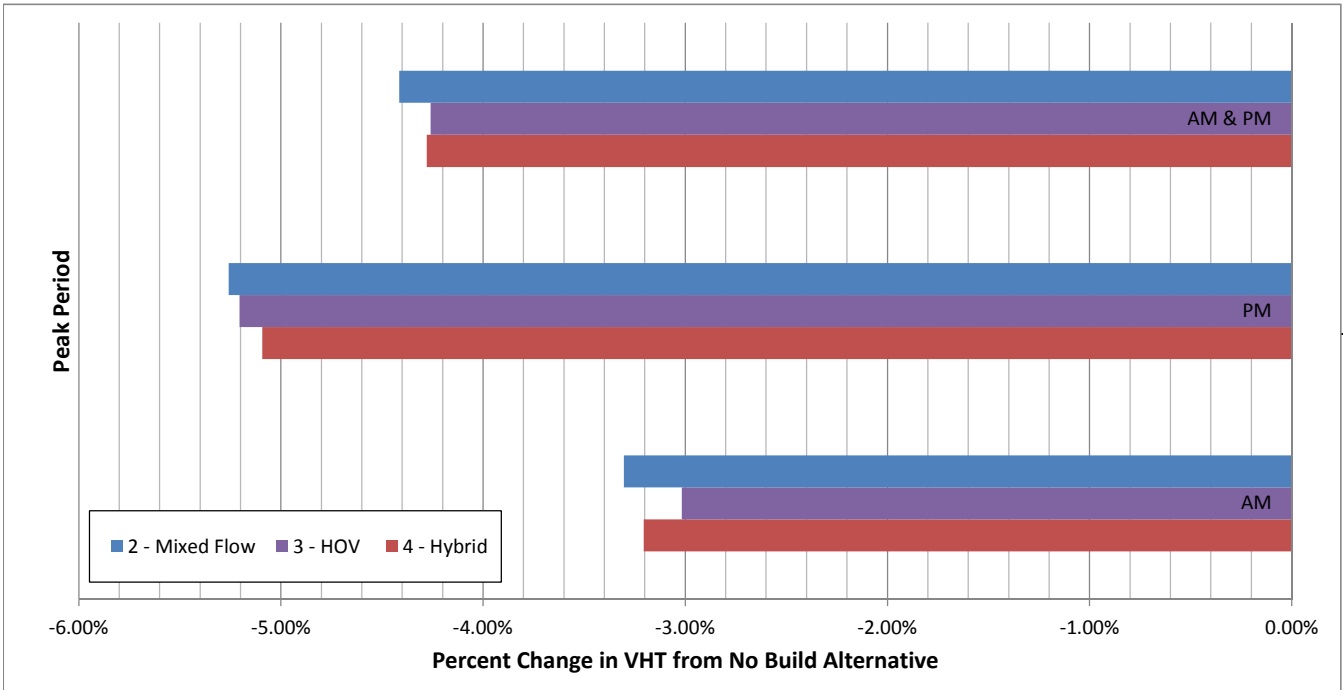
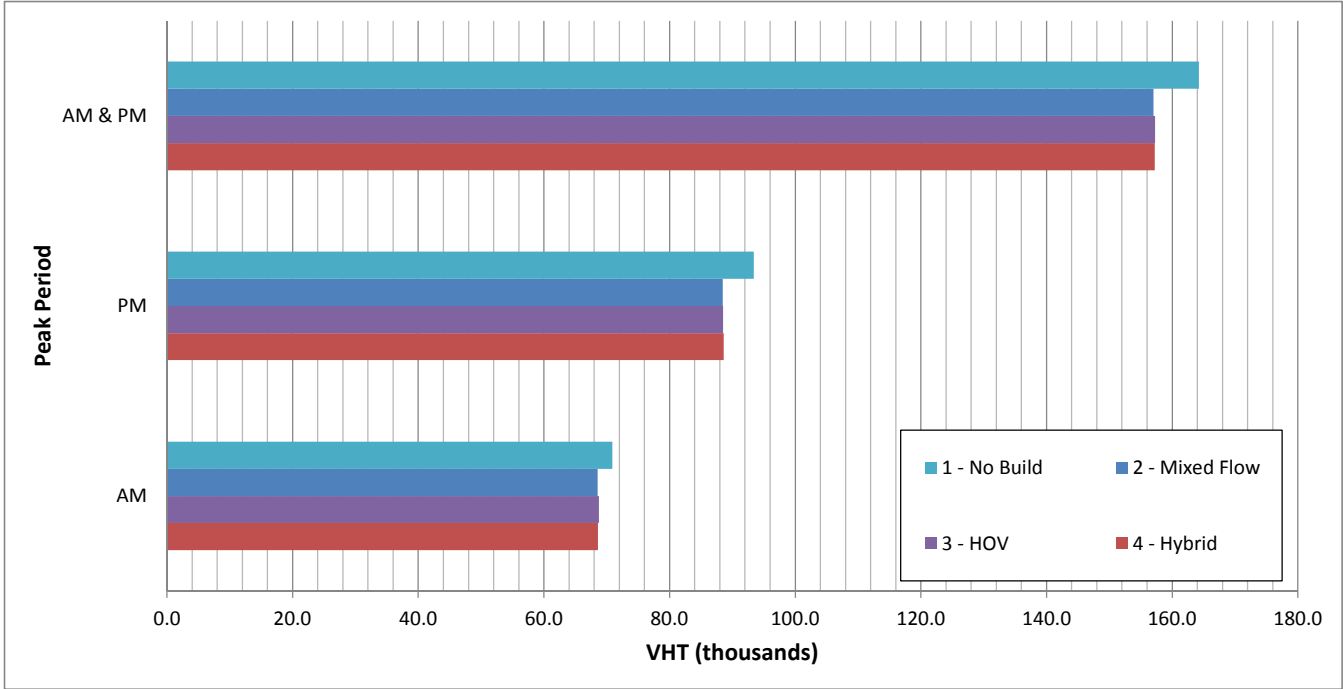

SR-65 WIDENING ALTERNATIVES DESIGN YEAR MESO-SCALE FREEWAY VHD COMPARISON

Alternative	Freeway Vehicle Hours of Delay*			% Change from No Build		
	AM	PM	AM & PM	AM	PM	AM & PM
1 - No Build	4,777	5,459	10,236	-	-	-
2 - Mixed Flow	3,937	3,414	7,351	-17.58%	-37.47%	-28.19%
3 - HOV	4,046	3,543	7,589	-15.30%	-35.10%	-25.86%
4 - Hybrid	3,941	3,500	7,440	-17.50%	-35.90%	-27.31%

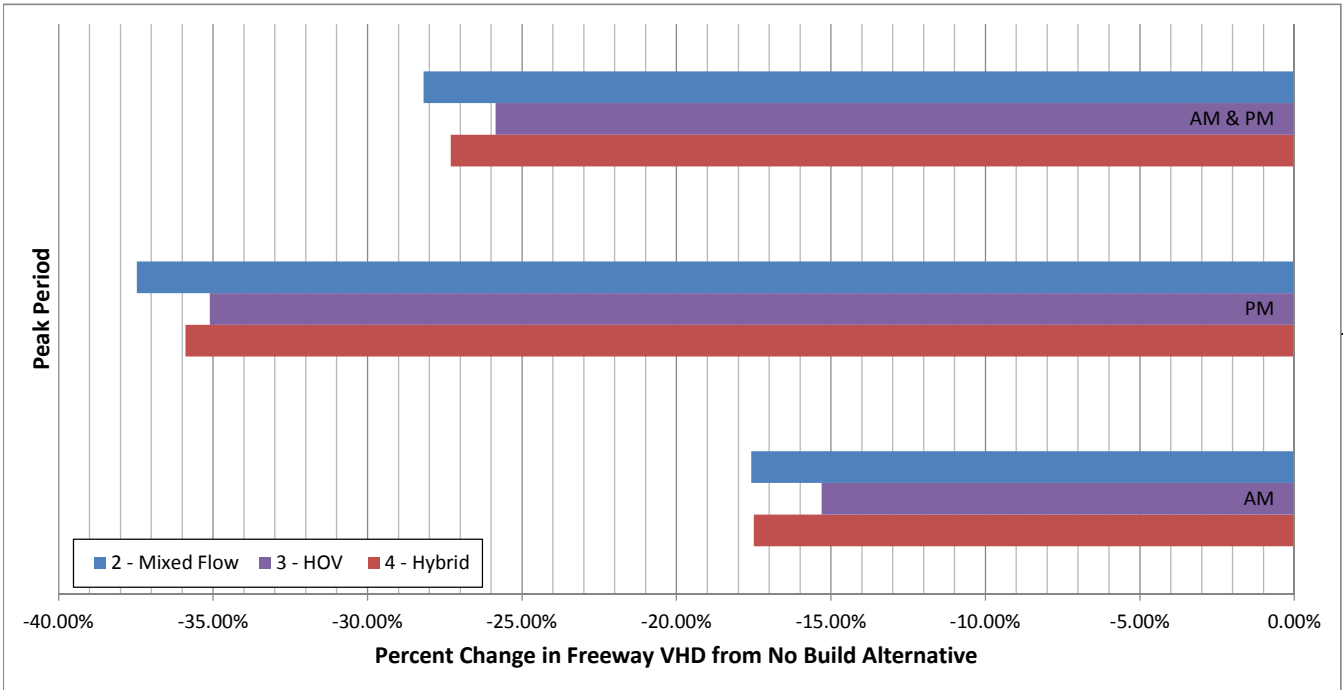
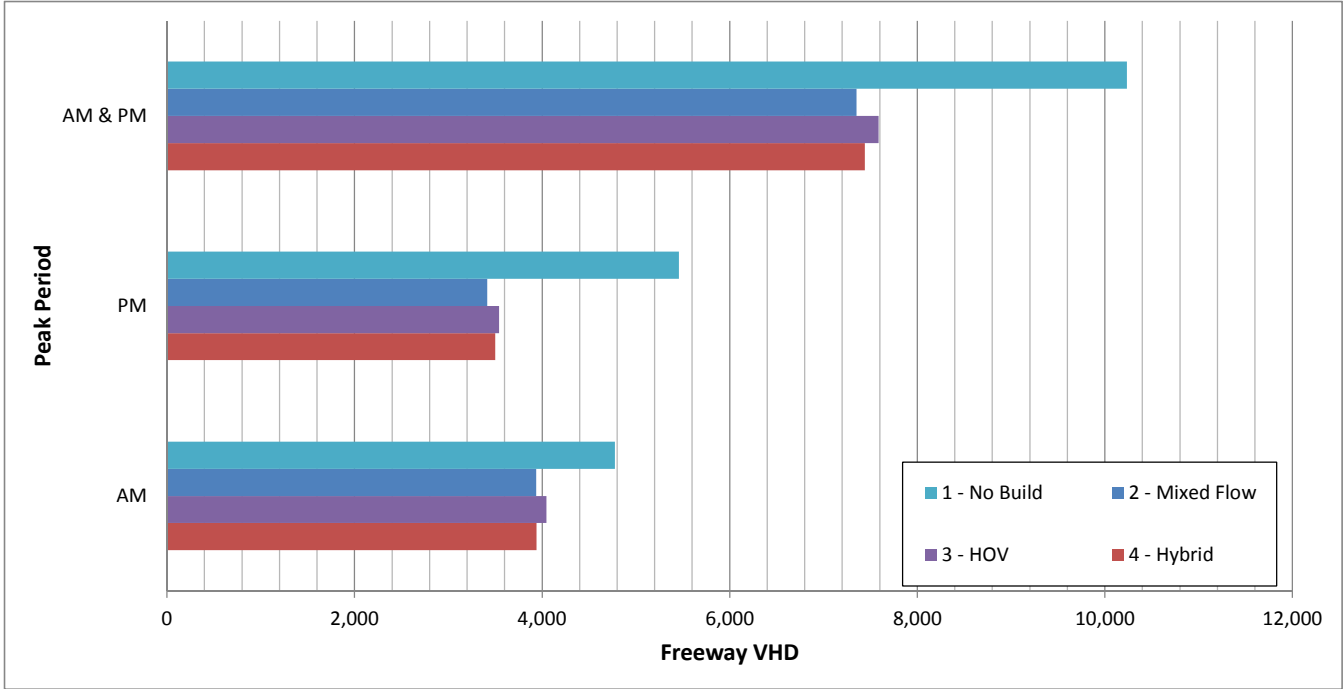

* Freeway VHD is measured only for freeway mainline links with an average speed less than 35 mph.

SR-65 WIDENING ALTERNATIVES DESIGN YEAR MESO-SCALE FREEWAY VHD COMPARISON

Alternative	Freeway Vehicle Hours of Delay*			% Change from No Build		
	AM	PM	AM & PM	AM	PM	AM & PM
1 - No Build	918	2,510	3,427	-	-	-
2 - Mixed Flow	20	402	422	-97.87%	-83.96%	-87.69%
3 - HOV	133	546	678	-85.53%	-78.26%	-80.21%
4 - Hybrid	85	631	716	-90.73%	-74.86%	-79.11%

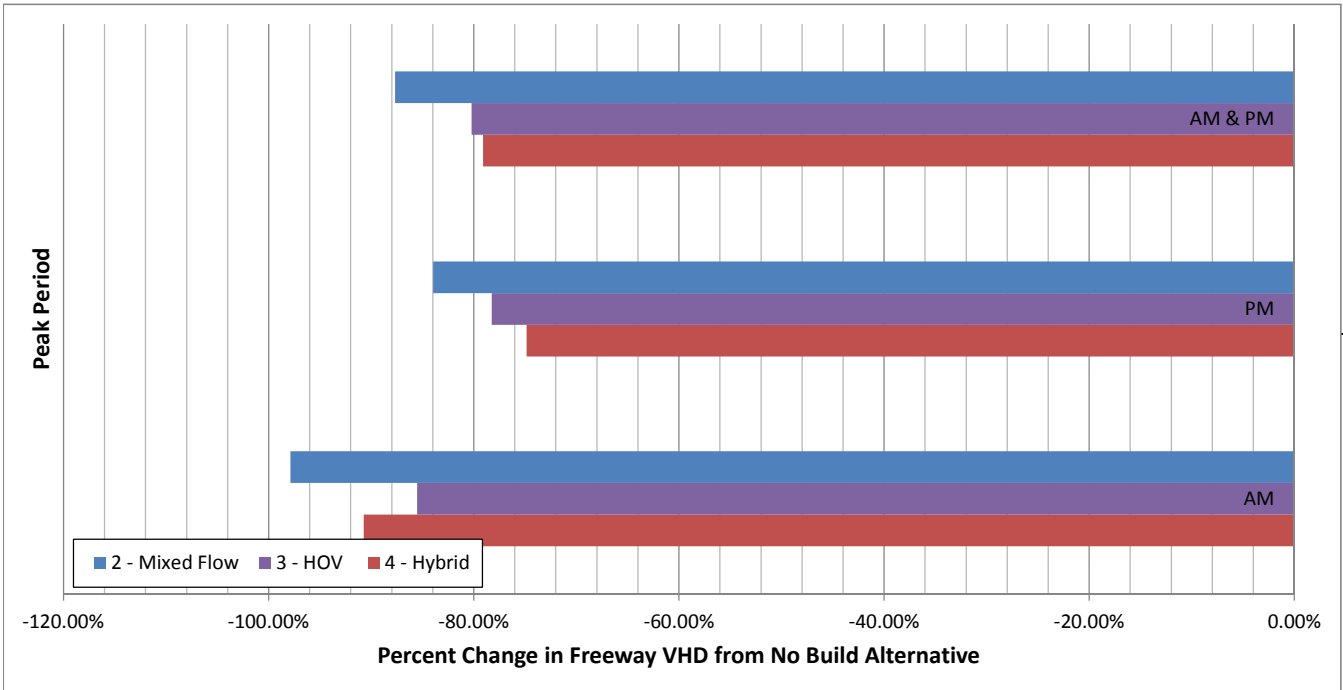
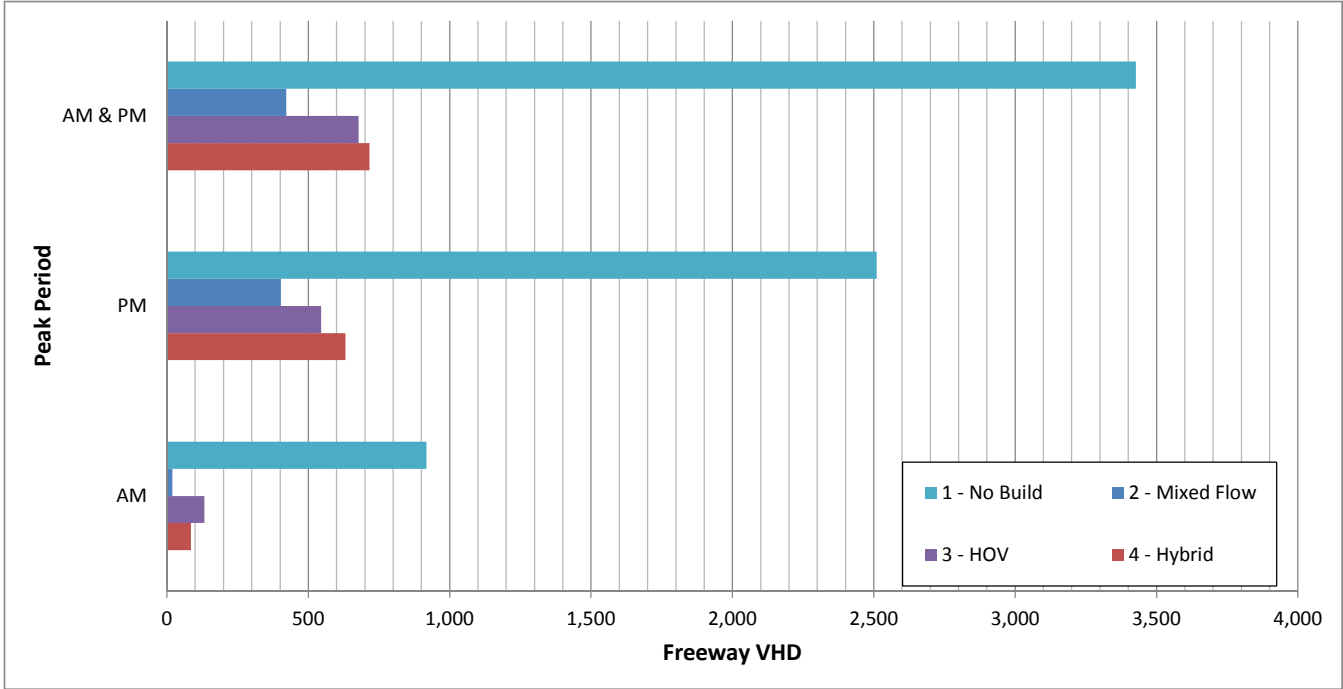

* Freeway VHD is measured only for freeway mainline links with an average speed less than 35 mph.

**SR-65 Widening
Alternative Comparison
Design Year**

AM Peak Period

Alt	VMT by Speed Bin												
	0-5 mph	5-10 mph	10-15 mph	15-20 mph	20-25 mph	25-30 mph	30-35 mph	35-40 mph	40-45 mph	45-50 mph	50-55 mph	55-60 mph	60-65 mph
No Build	7,604	30,875	99,862	165,479	185,384	241,965	293,856	309,960	194,665	115,042	170,906	132,280	33,516
Mixed Flow	7,647	29,053	91,891	146,155	161,692	211,567	283,024	299,668	203,917	137,716	192,195	170,726	58,857
HOV	7,645	29,240	92,570	142,558	165,044	217,290	290,189	309,719	196,950	130,829	196,086	141,005	38,421
Hybrid	7,645	29,052	91,574	143,536	163,560	210,857	288,039	301,697	205,349	140,710	187,614	154,616	56,112

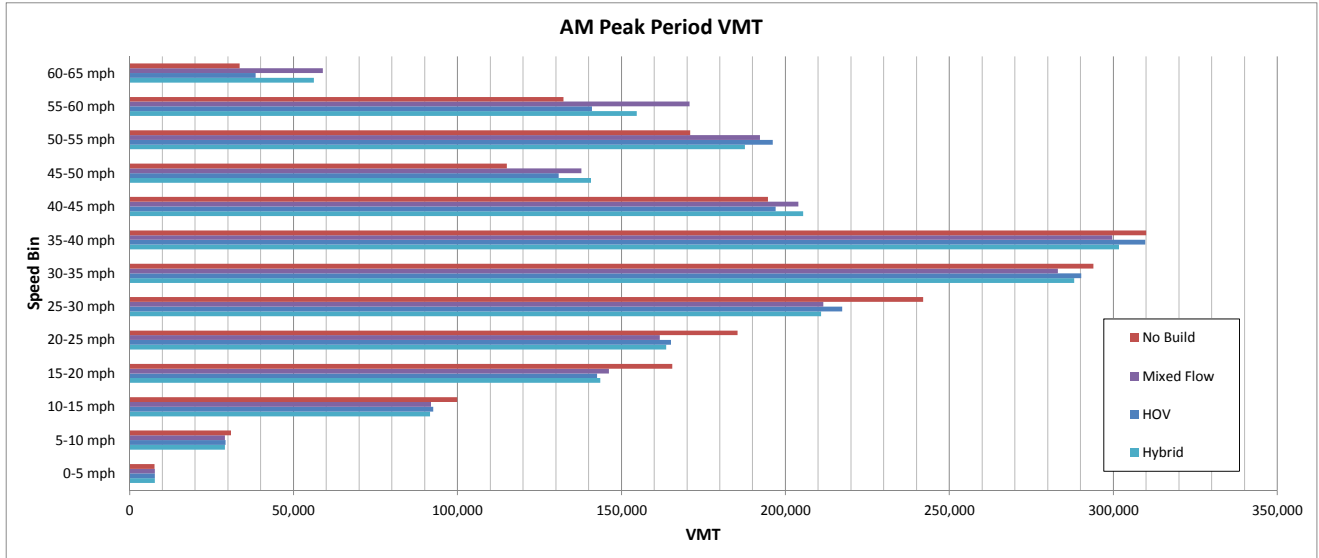

PM Peak Period

Alt	VMT by Speed Bin												
	0-5 mph	5-10 mph	10-15 mph	15-20 mph	20-25 mph	25-30 mph	30-35 mph	35-40 mph	40-45 mph	45-50 mph	50-55 mph	55-60 mph	60-65 mph
No Build	6,104	21,877	140,036	243,397	353,806	343,287	388,991	295,765	265,778	127,774	141,884	61,984	12,823
Mixed Flow	6,228	21,830	115,494	181,230	306,054	358,380	372,664	315,242	287,092	173,140	167,800	102,393	20,187
HOV	6,211	21,726	108,614	182,299	309,469	346,268	410,512	328,009	289,493	130,486	150,597	71,040	12,886
Hybrid	6,249	21,383	113,312	183,779	306,675	356,466	380,094	316,498	269,296	173,771	151,513	104,168	20,201

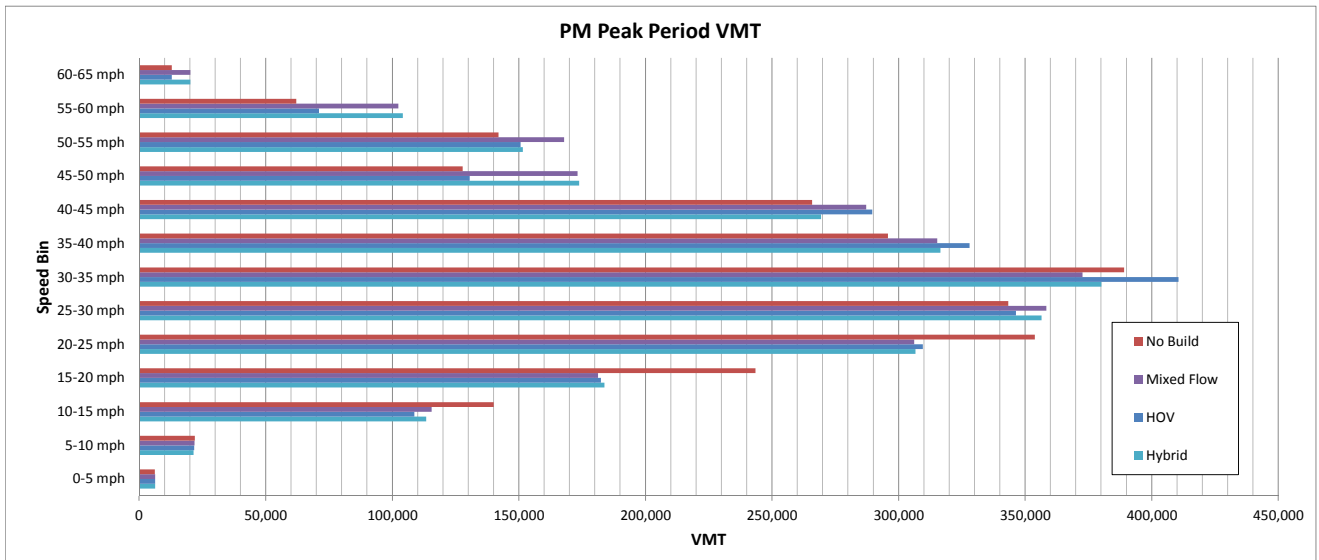

SR-65 WIDENING ALTERNATIVES DESIGN YEAR MESO-SCALE TRAVEL TIME COMPARISON - SOV

Alternative	Peak Hour Travel Time (min)				% Change from No Build			
	SB-AM	SB-PM	NB-AM	NB-PM	SB-AM	SB-PM	NB-AM	NB-PM
1 - No Build	17.69	14.28	10.78	19.70	-	-	-	-
2 - Mixed Flow	10.87	10.04	8.60	12.39	-38.56%	-29.70%	-20.24%	-37.14%
3 - HOV	12.90	11.00	9.22	14.35	-27.08%	-23.01%	-14.41%	-27.14%
4 - Hybrid	10.92	10.15	8.98	12.89	-38.26%	-28.97%	-16.66%	-34.58%

Note: Travel times are congested travel times in mixed flow lanes between Ferrari Ranch Rd and I-80 Ramps.

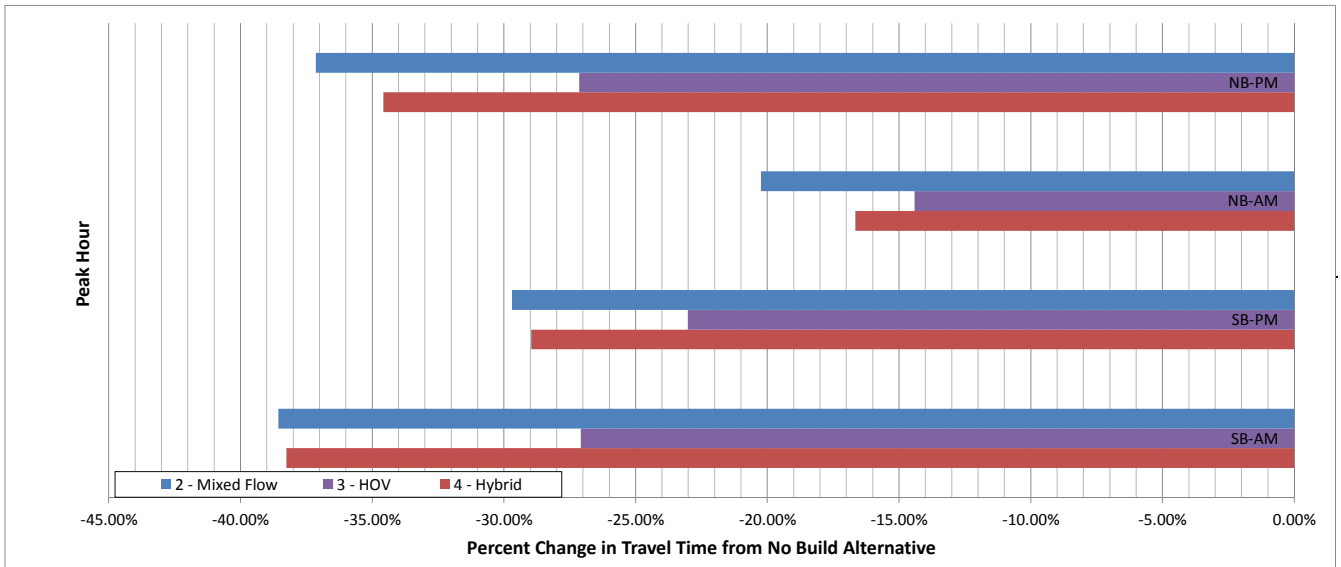
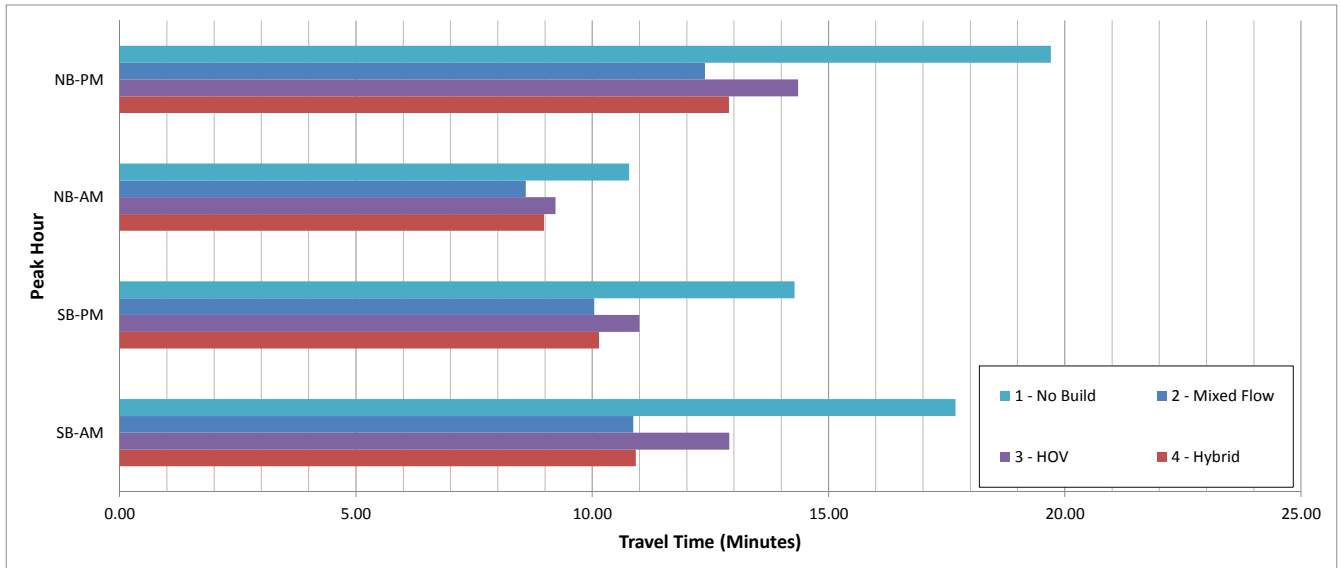

SR-65 WIDENING ALTERNATIVES DESIGN YEAR MESO-SCALE TRAVEL TIME COMPARISON - HOV

Alternative	Peak Hour Travel Time (min)				% Change from No Build			
	SB-AM	SB-PM	NB-AM	NB-PM	SB-AM	SB-PM	NB-AM	NB-PM
1 - No Build	17.02	13.22	10.56	19.22	-	-	-	-
2 - Mixed Flow	10.61	9.55	8.35	11.58	-37.66%	-27.74%	-20.91%	-39.74%
3 - HOV	9.50	8.97	7.88	10.28	-44.19%	-32.15%	-25.35%	-46.52%
4 - Hybrid	10.46	9.39	8.14	10.92	-38.58%	-28.96%	-22.95%	-43.18%

Note: Travel times are congested travel times for HOV vehicles that use HOV lanes between Ferrari Ranch Rd and I-80 Ramps.

